

233

True-rms Remote Display Digital Multimeter

PN 3465366

September 2009

© 2009 Fluke Corporation. All rights reserved. Printed in USA. Specifications are subject to change without notice.

All product names are trademarks of their respective companies.

LIMITED WARRANTY AND LIMITATION OF LIABILITY

This Fluke product will be free from defects in material and workmanship for three years from the date of purchase. This warranty does not cover fuses, disposable batteries, or damage from accident, neglect, misuse, alteration, contamination, or abnormal conditions of operation or handling. Resellers are not authorized to extend any other warranty on Fluke's behalf. To obtain service during the warranty period, contact your nearest Fluke authorized service center to obtain return authorization information, then send the product to that Service Center with a description of the problem.

THIS WARRANTY IS YOUR ONLY REMEDY. NO OTHER WARRANTIES, SUCH AS FITNESS FOR A PARTICULAR PURPOSE, ARE EXPRESSED OR IMPLIED. FLUKE IS NOT LIABLE FOR ANY SPECIAL, INDIRECT, INCIDENTAL OR CONSEQUENTIAL DAMAGES OR LOSSES, ARISING FROM ANY CAUSE OR THEORY. Since some states or countries do not allow the exclusion or limitation of an implied warranty or of incidental or consequential damages, this limitation of liability may not apply to you.

Fluke Corporation
P.O. Box 9090
Everett, WA 98206-9090
U.S.A.

Fluke Europe B.V.
P.O. Box 1186
5602 BD Eindhoven
The Netherlands

Introduction

The Fluke 233 (hereafter the Meter) is a compact and easy to operate tool for electrical and electronic circuit measurements.

⚠ ⚠ Warning

Read "Safety Information" before you use the Meter.

How to Contact Fluke

Use one of the telephone numbers below to speak with a Fluke representative:

Technical Support USA: 1-800-44-FLUKE (1-800-443-5853)

Calibration/Repair USA: 1-888-99-FLUKE (1-888-993-5853)

Canada: 1-800-36-FLUKE (1-800-363-5853)

Europe: +31 402-675-200

Japan: +81-3-3434-0181

Singapore: +65-738-5655

Anywhere in the world: +1-425-446-5500

Or, visit Fluke's website at www.fluke.com.

To register your product, visit <http://register.fluke.com>.

To see, print, or download the latest manual supplement, visit <http://us.fluke.com/usen/support/manuals>.

Safety Information

The Meter complies with:

- ISA-82.02.01
- CAN/CSA C22.2 No. 61010-1-04
- ANSI/UL 61010-1:2004
- EN 61010-1:2001
- EN 61326-1:2006
- EN 61326-2-2:2006
- ETSI EN 300 328 V1.7.1:2006
- ETSI EN 300 489 V1.8.1:2008
- FCC Part 15 Subpart C Sections 15.207, 15.209, 15.249 FCCID: T68-F233
- RSS-210 IC: 6627A-F233
- Measurement Category III, 1000V, Pollution Degree 2
- Measurement Category IV, 600V, Pollution Degree 2

In this manual, a **Warning** identifies the conditions and procedures that cause a dangerous situation to the user. A **Caution** identifies the conditions and procedures that could cause damage to the Meter, equipment under test damage, or permanent data loss.

The symbols used on the Meter and in this manual are shown in Table 1.

Warning

To prevent possible electrical shock or personal injury, follow these guidelines:

- **Use this Meter only as specified in this manual or the protection can be compromised.**
- **Do not use the Meter if it is damaged. Before you use the Meter, examine the case. Look for cracks or missing plastic. Carefully look at the insulation around the terminals.**
- **Make sure the battery door is closed and locked before you operate the Meter.**
- **Replace the batteries when the battery indicator () appears.**

- Remove the test leads from the Meter before the battery door on the Meter base is opened.
- Examine the test leads for damaged insulation or exposed metal. Measure the test leads for continuity. Replace damaged test leads before you use the Meter.
- Do not apply more than the rated voltage, shown on the Meter, between the terminals or between a terminal and earth ground.
- Do not operate the Meter with the battery door removed or the case open.
- Be careful around voltages >30 V ac rms, 42 V ac peak, or 60 V dc. These voltages pose a shock hazard.
- Use only the replacement fuse specified by the manual.
- Use the correct terminals, function, and range for measurements.
- Do not work alone.
- For current measurements, connect the Meter to the circuit after you remove circuit power. Always put the Meter in series with the circuit.
- Connect the common test lead before the live test lead and remove the live test lead before the common test lead.
- Do not use the Meter if it operates incorrectly. Protection can be compromised. If you are unsure, have the Meter examined.
- Do not use the Meter around explosive gas, vapor or in damp or wet environments.

















- Use only specified 1.5-V AA batteries (three in the Meter base and two in the display), correctly installed, for Meter power.
- Comply with local and national safety requirements when in hazardous locations.
- Only use test leads that have the same voltage, category, and amperage ratings as the Meter and that are approved by a safety Agency.
- Measure a known voltage first to make sure that the Meter operates correctly. If you are unsure, have the Meter examined.
- Use protective equipment, as directed by local or national authorities when in hazardous work areas.
- Measure the test leads for continuity before use. Do not use if the resistance is high or noisy.
- Use only specified replacement parts in the Meter.
- Keep fingers behind the finger guards on the probes.

⚠ Caution

To prevent damage to the Meter or to the equipment under test, follow these guidelines:

- Disconnect circuit power and discharge all high-voltage capacitors before you do diode tests or measure resistance, continuity, or capacitance.
- Use the correct terminals, function, and range for all measurements.
- Before a current measurement, do the fuse test.

Table 1. Electrical Symbols

	AC (Alternating Current)		Earth ground
	DC (Direct Current)		Fuse
	Hazardous voltage		Conforms to European Union directives.
	Risk of Danger. Important information. See Manual.		Conforms to relevant Canadian Standards Association directives.
	Battery. Low battery when shown.		Double insulated
	Continuity test or continuity beeper tone.		Capacitance
CAT III	IEC Measurement Category III CAT III equipment has protection against transients in equipment in fixed-equipment installations, such as distribution panels, feeders and short branch circuits, and lighting systems in large buildings.	CAT IV	IEC Measurement Category IV CAT IV equipment has protection against transients from the primary supply level, such as an electricity meter or an overhead or underground utility service.
	Do not discard this product as unsorted municipal waste. Go to the Fluke website for recycling data.		Diode
	Examined and licensed by TÜV Product Services.		Conforms to relevant Australian standards.

Features

See Tables 3 through 4 for a list of Meter features with a short feature description.

Table 2. Display

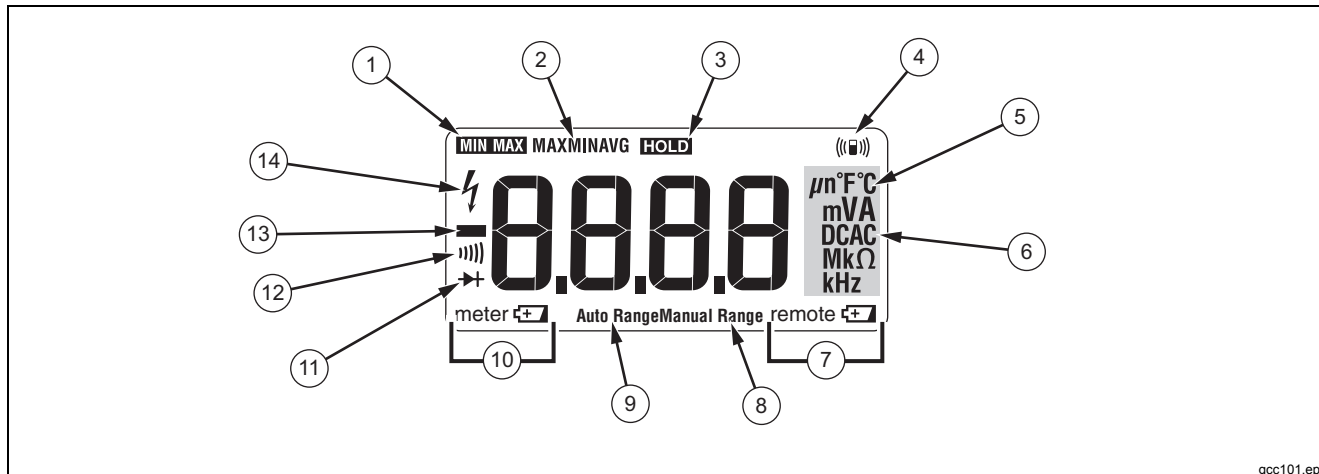

gcc101.eps

No.	Symbol	Indication
1	MIN MAX	MIN MAX AVG mode on.
2	MAX MIN AVG	Maximum, minimum, or average measurement shown.
3	HOLD	Display hold on. Display freezes the measurement.

Table 2. Display (cont.)







No.	Symbol	Indication
4	((□))	Radio connection indicator.
5	°C, °F	degrees Celsius, degrees Fahrenheit
6	A	amperes (amps)
	V, mV	volts, millivolts
	μF, nF	microfarad, nanofarad
	DC AC	Direct current or alternating current.
	Ω, MΩ, kΩ	ohm, megohm, kilohm
	Hz, kHz	hertz, kilohertz
7	remote 	Battery low warning for the display module.
8	Manual Range	Manual range set.
9	Auto Range	Auto range set.
10	meter 	Battery low warning for Meter base.
11		Diode test mode.
12)))	Continuity test.
13	-	Input is a negative value.
14		 Hazardous voltage. Measured input voltage ≥ 30 V, or voltage overload condition (OL). For frequency measurements > 1 kHz, the  symbol and high-voltage LED is unspecified.

Table 3. Inputs



gcc110.eps

No.	Terminal	Description
1	A	Input for 0 A to 10.00 A current measurements.
2	COM	Common terminal for all measurements.
3	 VΩ	Input for voltage, continuity, resistance, diode, capacitance, temperature, and frequency measurements.

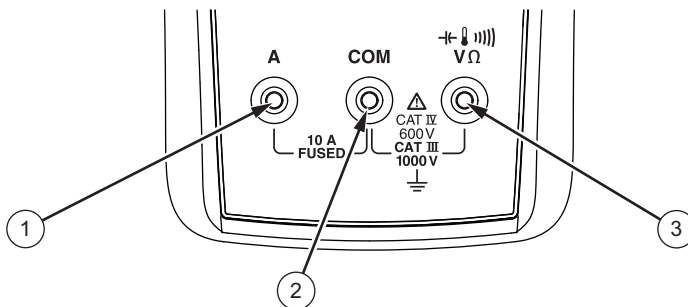
Table 4. Function Switch Positions

Switch Position	Description
\tilde{V}_{Hz} Hz (button)	AC voltage from 0.06 to 1000 V. Frequency from 5 Hz to 50 kHz.
\overline{V}	DC voltage from 0.001 V to 1000 V.
\overline{mV}	AC voltage from 6.0 to 600.0 mV, dc-coupled. DC voltage from 0.1 to 600.0 mV.
Ω	Ohms from 0.1 Ω to 40 M Ω . Continuity beeper turns on at <20 Ω and turns off at >250 Ω .
$\overleftarrow{F} \rightarrow$	Farads from 1 nF to 9999 μ F. Diode Test. OL shows in the display when the input voltage is >2.0 V.
\updownarrow	Temperature.
\tilde{A}_{Hz} Hz (button)	AC current from 0.1 A to 10 A (>10 to 20 A, 30 seconds on, 10 minutes off). >10.00 A display flashes. >20 A, OL is shown. DC-coupled. Frequency from 45 Hz to 5 kHz.
\overline{A}	DC current from 0.001 A to 10 A (>10 to 20 A, 30 seconds on, 10 minutes off). >10.00 A display flashes. >20 A, OL is shown.
Note: All ac functions are true-rms. AC voltage is ac-coupled. AC mV and ac amps are dc-coupled.	

Error Messages

Table 5 contains possible error messages and the steps to clear the error.

Table 5. Error Messages

Error Messages	
bAtt d ISP	Display-module batteries must be replaced before the Meter will operate.
bAtt bASE	Meter-base batteries must be replaced before the Meter will operate.
CAL Err	Calibration necessary. Meter calibration is necessary before the Meter will operate.
EEPROM Err	Internal error. The Meter must be repaired before it will operate.
rF Err	Loss of radio connection with the Meter base.

Remote Operation

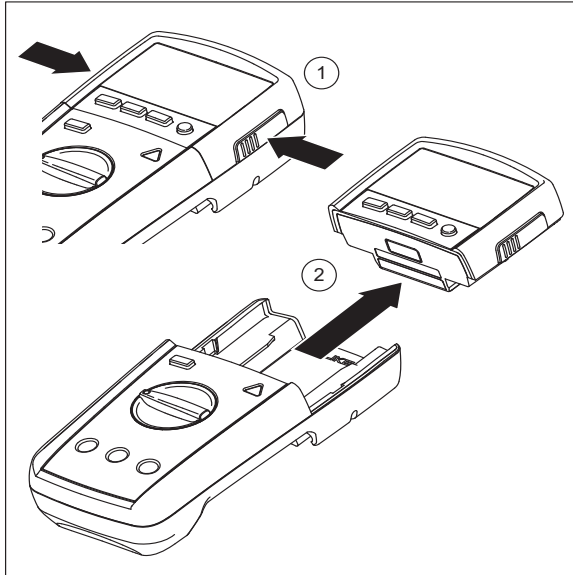

gcc114.eps

Figure 1. Display Module Separation

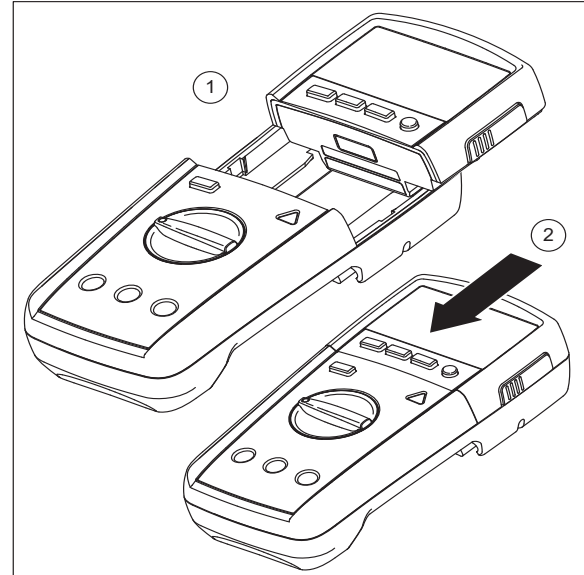

gcc115.eps

Figure 2. Dock Display Module with Meter Base

Fuse Test

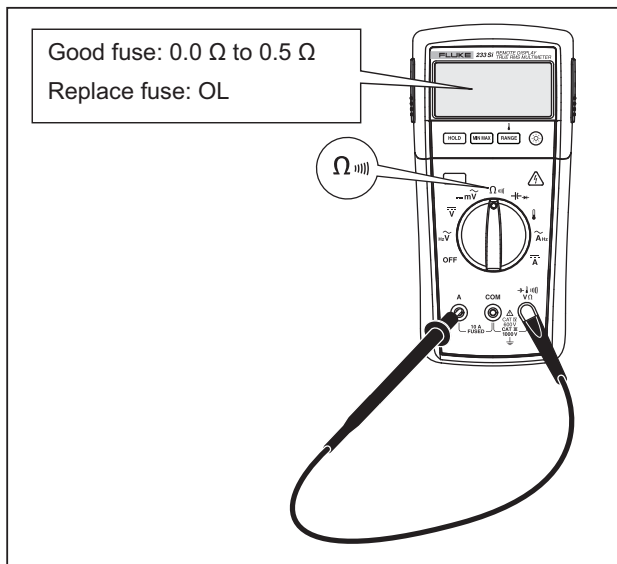

Figure 3. Fuse Test

gcc105.eps

Battery Replacement

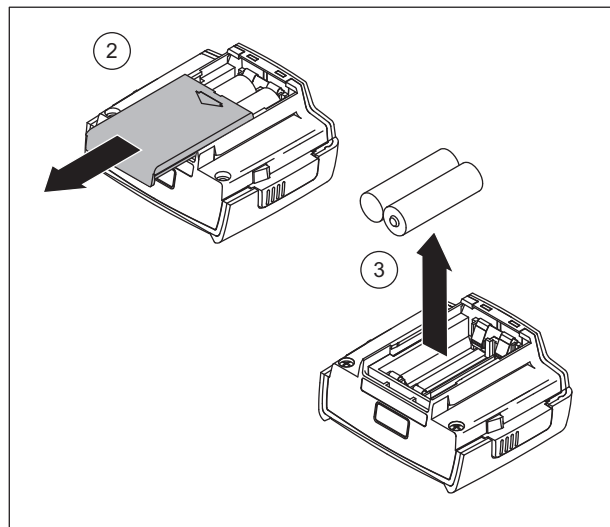
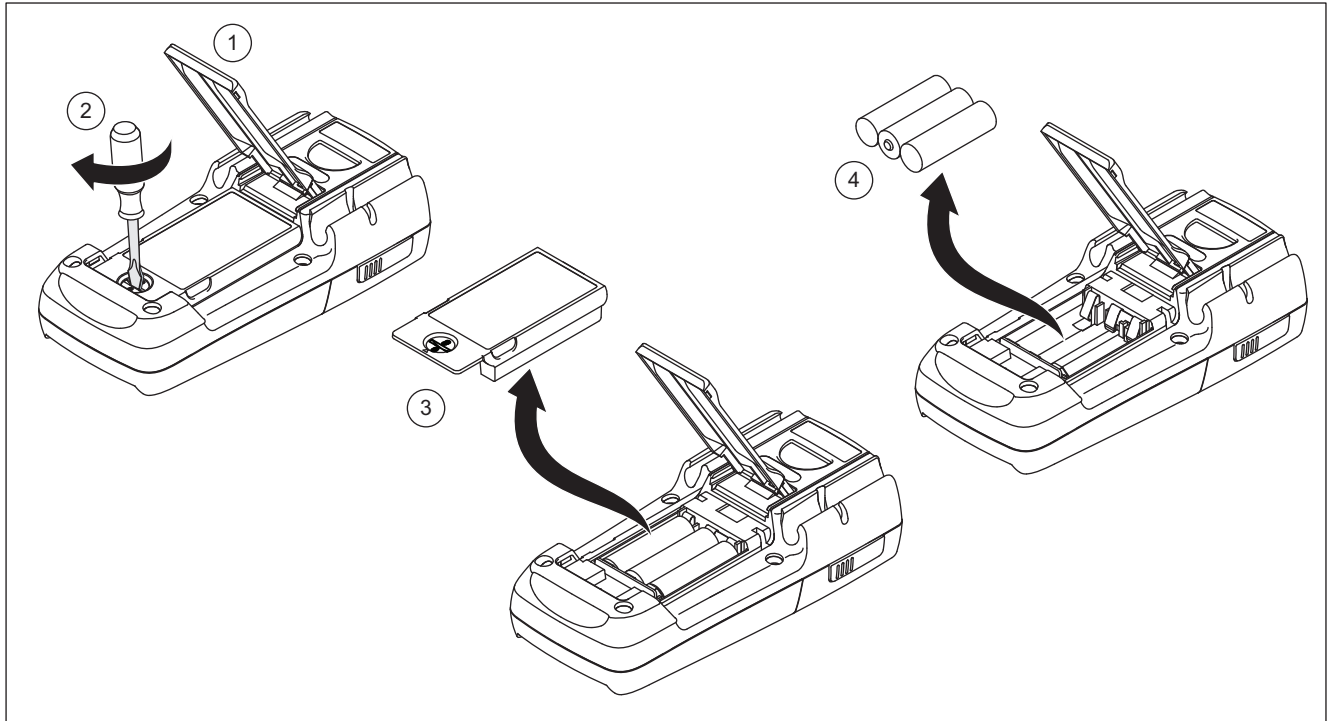

Figure 4. Display-Module Battery Removal

gcc111.eps



gcc112.eps

Figure 5. Meter Base Battery Replacement

General Specifications

Maximum voltage between any terminal and earth ground	1000 V rms
⚠ Fuse for A inputs	11 A, 1000 V 17000A interrupt rating Fuse
Altitude	
Operating	2,000 meters
Storage	12,000 meters
Temperature	
Operating	-10 °C to +50 °C
Storage	-40 °C to +60 °C
Temperature coefficient	0.1 X (specified accuracy) / °C (< 18 °C or > 28 °C)
Electromagnetic Compatibility (EN 61326-1:2006)	In an RF field of 3 V/m, accuracy = specified accuracy except in temperature: specified accuracy ± 5 °C (9 °F)
Wireless Frequency	2.4 GHz ISM Band 10 meter range
Relative Humidity	Maximum noncondensing, 90 % at 35 °C, 75 % at 40 °C, 45 % at 50 °C, 0 % to 70 % for 40 M Ω range
Battery Type	
Meter base	Three AA Alkaline batteries, NEDA 15A IEC LR6
Display module	Two AA Alkaline batteries, NEDA 15A IEC LR6
Battery Life	400 hrs typical (Alkaline)
Shock	1 Meter drop 6 sides per IEC 61010
Safety Compliance	Complies with ANSI/ISA S82.01-2004, CSA 22.2 No. 61010-1-04 to 1000 V Measurement Category III and 600 V Measurement Category IV.
Certifications	CSA, TÜV (EN61010), C $\text{\textcircled{C}}$,  (N10140), VDE, GOST

Manual Supplement



Manual Title: 233 Getting Started
Part Number: 3465366
Print Date: September 2009
Revision/Date:

Supplement Issue: **2**
Issue Date: 5/10
Page Count: 2

This supplement contains information necessary to ensure the accuracy of the above manual.

Change #1

On page 2, under **Safety Information** add the following:

- CMIID: 2009DJ6034
-  R206WWJUX000013
-  R206WWJUX000012

- 
Agência Nacional de Telecomunicações
0749-10-5988

(01)07898941652

Este equipamento trabalha em caráter secundário, isto é, não tem direito a proteção contra a interferência prejudicial, mesmo de estações do mesmo tipo, e não pode causar interferência a sistemas operando em caráter primário.

Change #2

On page 2, under Warnings, add the following:

- **Remove batteries when not in use for two or more months, this reduces the chance of battery leakage and corrosion.**
- **When your Fluke 233 Digital Multimeter batteries go dead, remove them immediately and replace them with new batteries.**