

BCR6AM-12L

Triac

Medium Power Use

REJ03G0294-0200

Rev.2.00

Nov.08.2004

Features

- $I_{T(RMS)}$: 6 A
- V_{DRM} : 600 V
- $I_{FGTI}, I_{RGTI}, I_{RGT}$: 30 mA (20 mA)^{Note6}
- Non-Insulated Type
- Planar Passivation Type

Outline

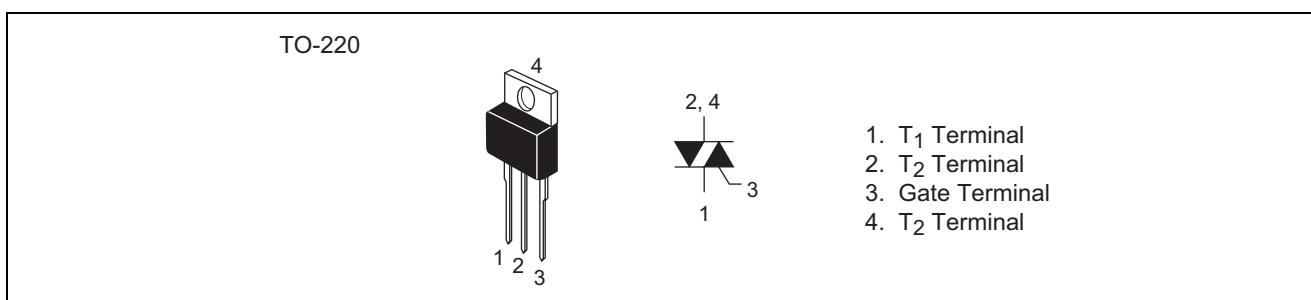

Applications

Contactless AC switch, light dimmer, electronic flasher unit, control of household equipment such as TV sets, stereo systems, washing machine, infrared kotatsu, carpet, electric fan, solenoid driver, small motor control, solid state relay, copying machine, electric heater control, and other general purpose control applications

Maximum Ratings

Parameter	Symbol	Voltage class	Unit
		12	
Repetitive peak off-state voltage ^{Note1}	V_{DRM}	600	V
Non-repetitive peak off-state voltage ^{Note1}	V_{DSM}	720	V

Parameter	Symbol	Ratings	Unit	Conditions
RMS on-state current	$I_{T(RMS)}$	6	A	Commercial frequency, sine full wave 360° conduction, $T_c = 103^{\circ}\text{C}$ ^{Note3}
Surge on-state current	I_{TSM}	60	A	60Hz sinewave 1 full cycle, peak value, non-repetitive
I^2t for fusing	I^2t	15	A^2s	Value corresponding to 1 cycle of half wave 60Hz, surge on-state current
Peak gate power dissipation	P_{GM}	5	W	
Average gate power dissipation	$P_{G(AV)}$	0.5	W	
Peak gate voltage	V_{GM}	10	V	
Peak gate current	I_{GM}	2	A	
Junction temperature	T_j	- 40 to +125	$^{\circ}\text{C}$	
Storage temperature	T_{stg}	- 40 to +125	$^{\circ}\text{C}$	
Mass	—	2.0	g	Typical value

Notes: 1. Gate open.

Electrical Characteristics

Parameter	Symbol	Min.	Typ.	Max.	Unit	Test conditions
Repetitive peak off-state current	I_{DRM}	—	—	2.0	mA	$T_j = 125^{\circ}\text{C}$, V_{DRM} applied
On-state voltage	V_{TM}	—	—	1.7	V	$T_c = 25^{\circ}\text{C}$, $I_{TM} = 9\text{ A}$, Instantaneous measurement
Gate trigger voltage ^{Note2}	I	V_{FGTI}	—	—	1.5	$T_j = 25^{\circ}\text{C}$, $V_D = 6\text{ V}$, $R_L = 6\ \Omega$, $R_G = 330\ \Omega$
	II	V_{RGTI}	—	—	1.5	
	III	V_{RGTIII}	—	—	1.5	
Gate trigger current ^{Note2}	I	I_{FGTI}	—	—	30 ^{Note6}	$T_j = 25^{\circ}\text{C}$, $V_D = 6\text{ V}$, $R_L = 6\ \Omega$, $R_G = 330\ \Omega$
	II	I_{RGTI}	—	—	30 ^{Note6}	
	III	I_{RGTIII}	—	—	30 ^{Note6}	
Gate non-trigger voltage	V_{GD}	0.2	—	—	V	$T_j = 125^{\circ}\text{C}$, $V_D = 1/2 V_{DRM}$
Thermal resistance	$R_{th(j-c)}$	—	—	2.5	$^{\circ}\text{C}/\text{W}$	Junction to case ^{Note3 Note4}
Critical-rate of rise of off-state commutating voltage ^{Note5}	$(dv/dt)_c$	10	—	—	$\text{V}/\mu\text{s}$	$T_j = 125^{\circ}\text{C}$

Notes: 2. Measurement using the gate trigger characteristics measurement circuit.

3. Case temperature is measured at the T_2 tab 1.5 mm away from the molded case.

4. The contact thermal resistance $R_{th(c-f)}$ in case of greasing is $1.0^{\circ}\text{C}/\text{W}$.

5. Test conditions of the critical-rate of rise of off-state commutating voltage is shown in the table below.

6. High sensitivity ($I_{GT} \leq 20\text{ mA}$) is also available. (I_{GT} item: 1)

Test conditions	Commutating voltage and current waveforms (inductive load)
1. Junction temperature $T_j = 125^{\circ}\text{C}$ 2. Rate of decay of on-state commutating current $(di/dt)_c = - 3.0\text{ A/ms}$ 3. Peak off-state voltage $V_D = 400\text{ V}$	

Performance Curves

Maximum On-State Characteristics

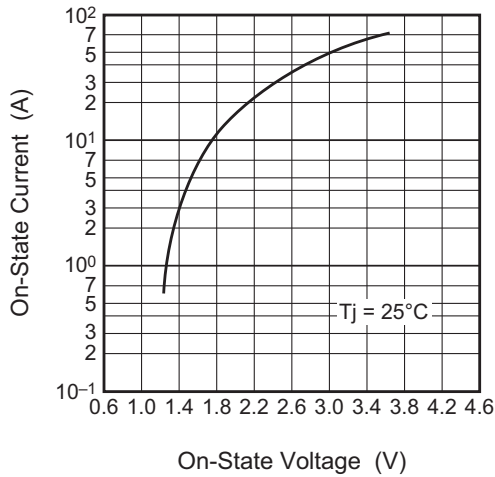

Rated Surge On-State Current

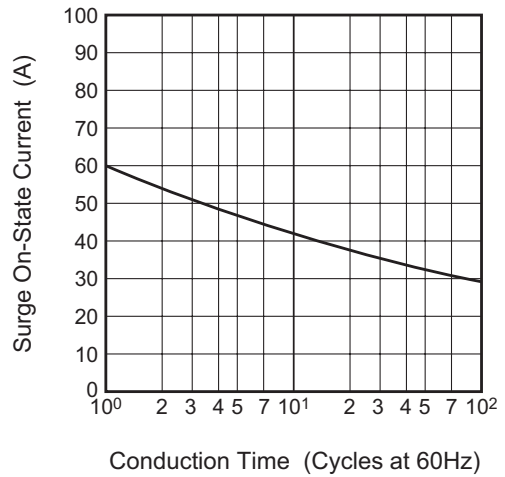

Gate Characteristics (I, II and III)

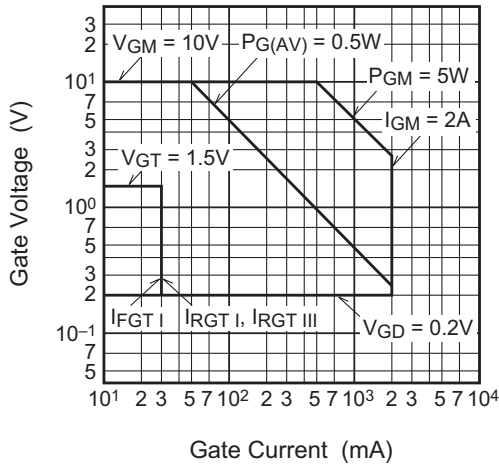

Gate Trigger Current vs. Junction Temperature

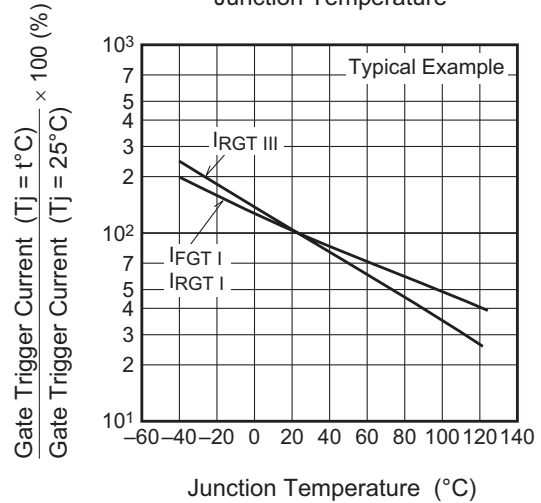

Gate Trigger Voltage vs. Junction Temperature

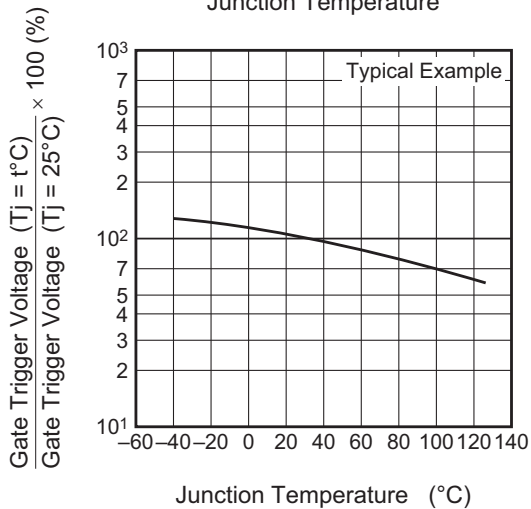

Maximum Transient Thermal Impedance Characteristics (Junction to case)

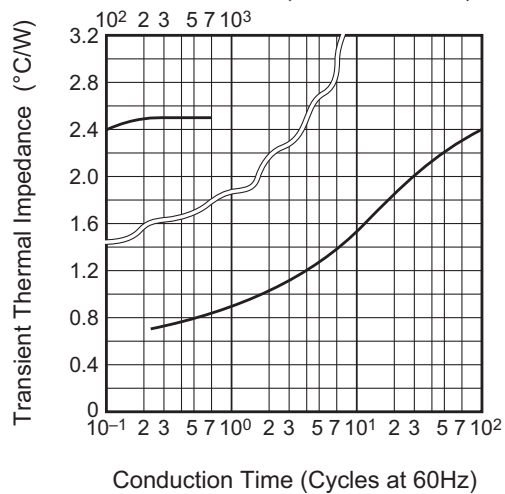

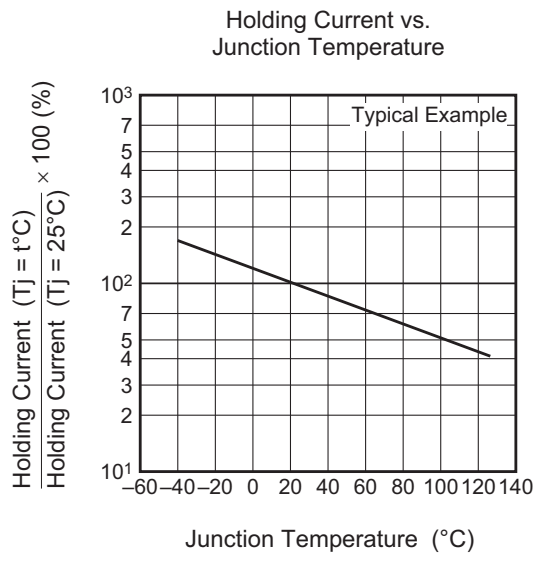
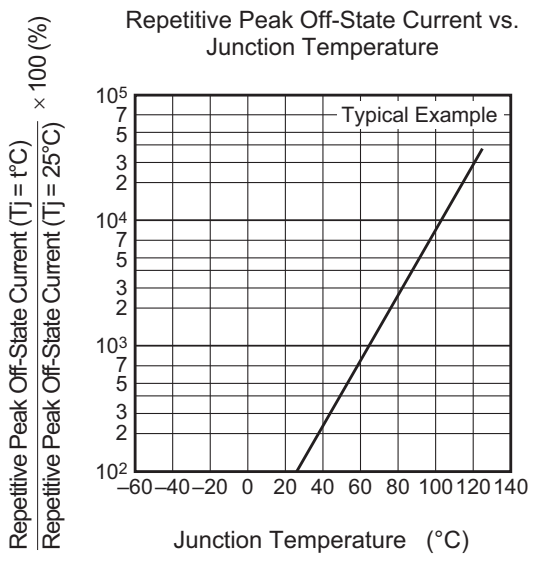
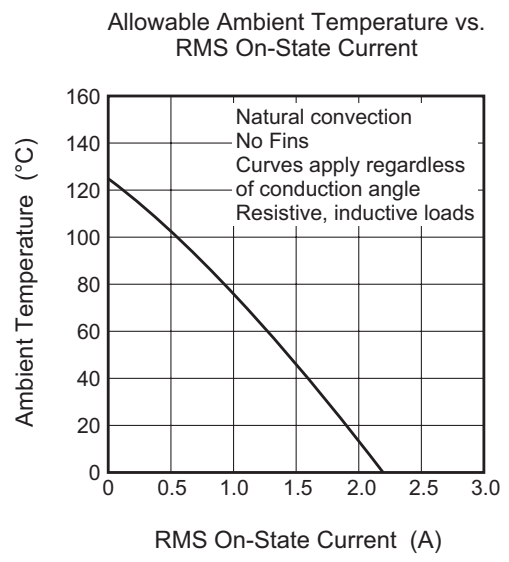
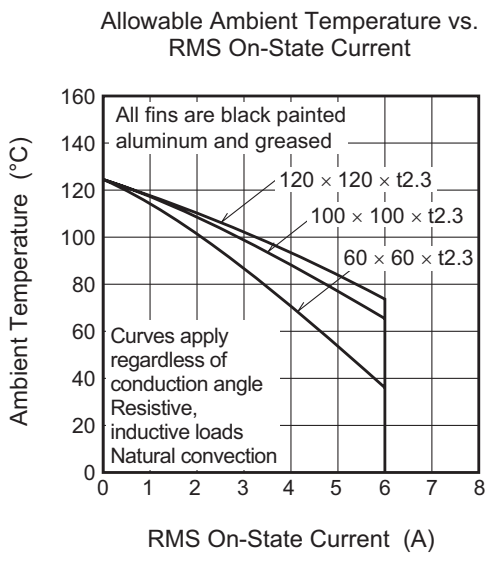
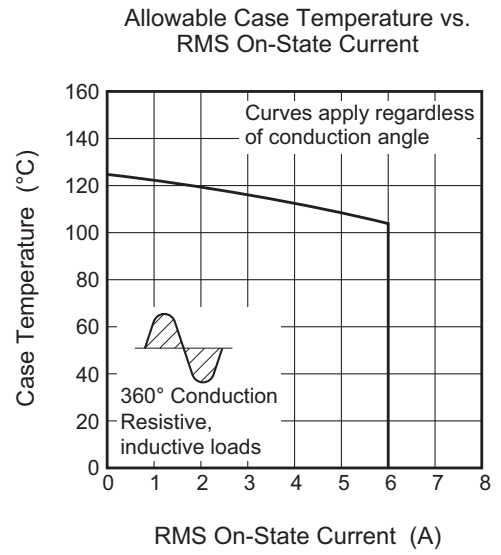
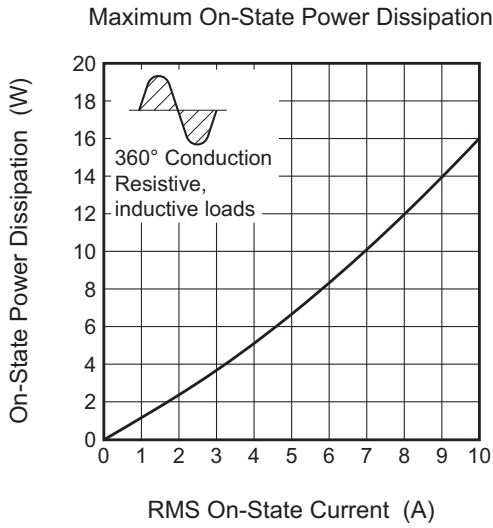

Latching Current vs. Junction Temperature

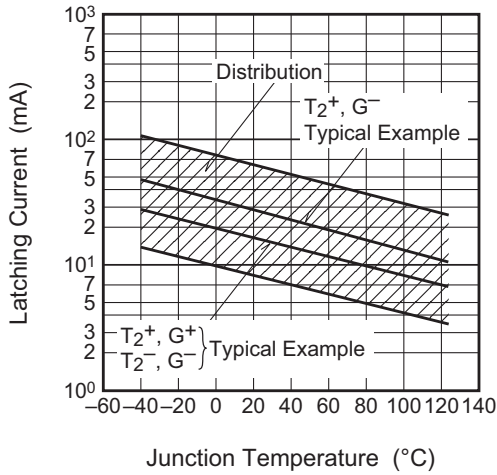

Breakover Voltage vs. Junction Temperature

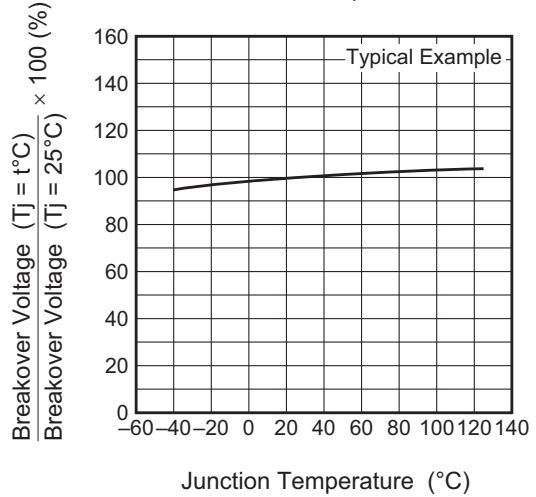

Breakover Voltage vs. Rate of Rise of Off-State Voltage

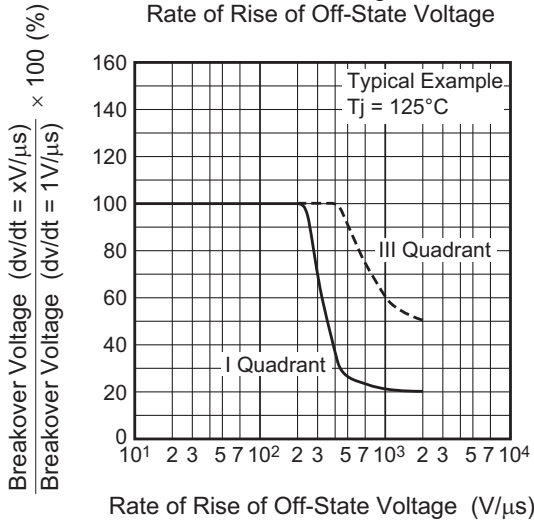

Commutation Characteristics

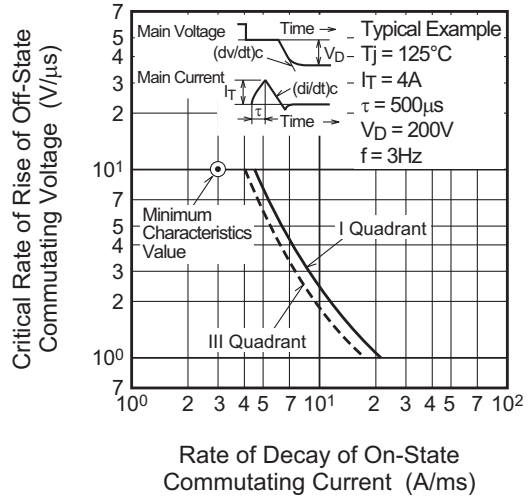

Gate Trigger Current vs. Gate Current Pulse Width

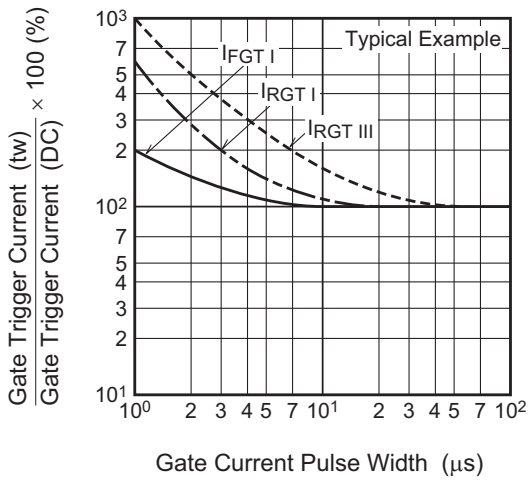

Gate Trigger Characteristics Test Circuits

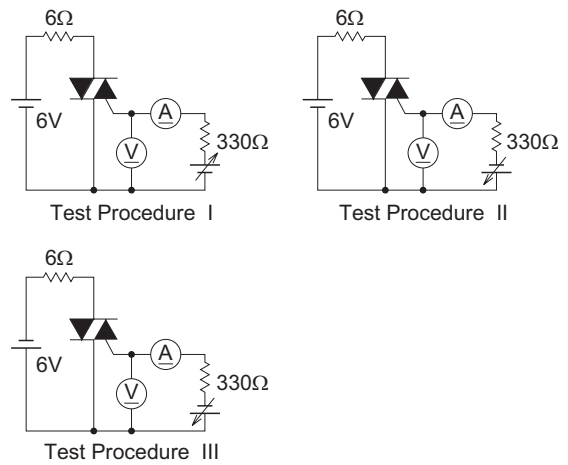

Package Dimensions

TO-220

EIAJ Package Code	JEDEC Code	Mass (g) (reference value)	Lead Material
Conforms	Conforms	2.0	Cu alloy

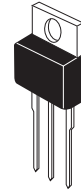
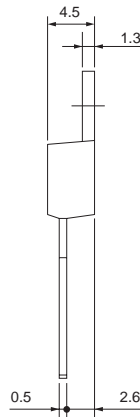
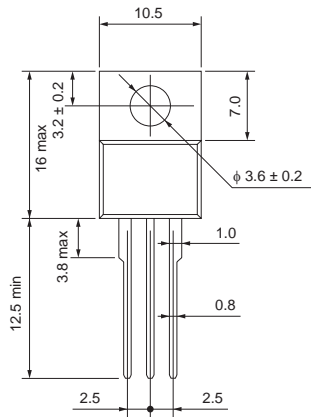

Note 1) The dimensional figures indicate representative values unless otherwise the tolerance is specified.

Symbol	Dimension in Millimeters		
	Min	Typ	Max
A	—	—	—
A ₁	—	—	—
A ₂	—	—	—
b	—	—	—
D	—	—	—
E	—	—	—
e	—	—	—
x	—	—	—
y	—	—	—
y ₁	—	—	—
ZD	—	—	—
ZE	—	—	—

Order Code

Lead form	Standard packing	Quantity	Standard order code	Standard order code example
Straight type	Vinyl sack	100	Type name +A	BCR6AM-12LA
Lead form	Plastic Magazine (Tube)	50	Type name +A – Lead forming code	BCR6AM-12LA-A8

Note : Please confirm the specification about the shipping in detail.

Renesas Technology Corp. Sales Strategic Planning Div. Nippon Bldg., 2-6-2, Ohte-machi, Chiyoda-ku, Tokyo 100-0004, Japan

Keep safety first in your circuit designs!

1. Renesas Technology Corp. puts the maximum effort into making semiconductor products better and more reliable, but there is always the possibility that trouble may occur with them. Trouble with semiconductors may lead to personal injury, fire or property damage.
Remember to give due consideration to safety when making your circuit designs, with appropriate measures such as (i) placement of substitutive, auxiliary circuits, (ii) use of nonflammable material or (iii) prevention against any malfunction or mishap.

Notes regarding these materials

1. These materials are intended as a reference to assist our customers in the selection of the Renesas Technology Corp. product best suited to the customer's application; they do not convey any license under any intellectual property rights, or any other rights, belonging to Renesas Technology Corp. or a third party.
 2. Renesas Technology Corp. assumes no responsibility for any damage, or infringement of any third-party's rights, originating in the use of any product data, diagrams, charts, programs, algorithms, or circuit application examples contained in these materials.
 3. All information contained in these materials, including product data, diagrams, charts, programs and algorithms represents information on products at the time of publication of these materials, and are subject to change by Renesas Technology Corp. without notice due to product improvements or other reasons. It is therefore recommended that customers contact Renesas Technology Corp. or an authorized Renesas Technology Corp. product distributor for the latest product information before purchasing a product listed herein.
The information described here may contain technical inaccuracies or typographical errors.
Renesas Technology Corp. assumes no responsibility for any damage, liability, or other loss rising from these inaccuracies or errors.
Please also pay attention to information published by Renesas Technology Corp. by various means, including the Renesas Technology Corp. Semiconductor home page (<http://www.renesas.com>).
 4. When using any or all of the information contained in these materials, including product data, diagrams, charts, programs, and algorithms, please be sure to evaluate all information as a total system before making a final decision on the applicability of the information and products. Renesas Technology Corp. assumes no responsibility for any damage, liability or other loss resulting from the information contained herein.
 5. Renesas Technology Corp. semiconductors are not designed or manufactured for use in a device or system that is used under circumstances in which human life is potentially at stake. Please contact Renesas Technology Corp. or an authorized Renesas Technology Corp. product distributor when considering the use of a product contained herein for any specific purposes, such as apparatus or systems for transportation, vehicular, medical, aerospace, nuclear, or undersea repeater use.
 6. The prior written approval of Renesas Technology Corp. is necessary to reprint or reproduce in whole or in part these materials.
 7. If these products or technologies are subject to the Japanese export control restrictions, they must be exported under a license from the Japanese government and cannot be imported into a country other than the approved destination.
Any diversion or reexport contrary to the export control laws and regulations of Japan and/or the country of destination is prohibited.
 8. Please contact Renesas Technology Corp. for further details on these materials or the products contained therein.
-



RENESAS SALES OFFICES

<http://www.renesas.com>

Refer to "<http://www.renesas.com/en/network>" for the latest and detailed information.

Renesas Technology America, Inc.
450 Holger Way, San Jose, CA 95134-1368, U.S.A
Tel: <1> (408) 382-7500, Fax: <1> (408) 382-7501

Renesas Technology Europe Limited
Dukes Meadow, Millboard Road, Bourne End, Buckinghamshire, SL8 5FH, U.K.
Tel: <44> (1628) 585-100, Fax: <44> (1628) 585-900

Renesas Technology Hong Kong Ltd.
7th Floor, North Tower, World Finance Centre, Harbour City, 1 Canton Road, Tsimshatsui, Kowloon, Hong Kong
Tel: <852> 2265-6688, Fax: <852> 2730-6071

Renesas Technology Taiwan Co., Ltd.
10th Floor, No.99, Fushing North Road, Taipei, Taiwan
Tel: <886> (2) 2715-2888, Fax: <886> (2) 2713-2999

Renesas Technology (Shanghai) Co., Ltd.
Unit2607 Ruijing Building, No.205 Maoming Road (S), Shanghai 200020, China
Tel: <86> (21) 6472-1001, Fax: <86> (21) 6415-2952

Renesas Technology Singapore Pte. Ltd.
1 Harbour Front Avenue, #06-10, Keppel Bay Tower, Singapore 098632
Tel: <65> 6213-0200, Fax: <65> 6278-8001