



LA3361

PLL FM Multiplex Stereo Demodulator

Overview

The LA3361, PLL FM multiplex stereo demodulator, is designed for low supply voltage-use appliance such as portable radio or car stereo.

Features

- Wide supply voltage range down to low supply voltage : 3V min.
- Operation of forced monaural (IF muting) or VCO stopping by only one pin.
Depending on supply voltage :
0.7V < V₉ < 2.1V : forced monaural (IF muting)
V₉ > 2.1V : VCO stopping
- Good ripple rejection.
- High level of lamp turning-on sensitivity : 7mV.
- With separation control pin.
- High gain.
- Less current consumption : 8.5mA typical.

Package Dimensions

unit:mm

3006B-DIP16

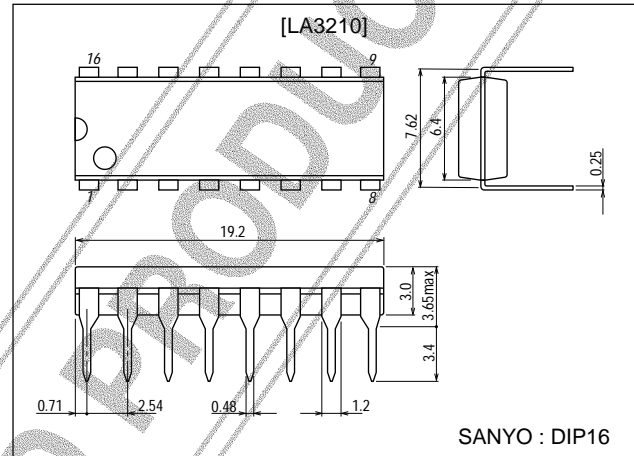

Specifications

Absolute Maximum Ratings at Ta = 25°C

Parameter	Symbol	Conditions	Ratings	Unit
Maximum Supply Voltage	V _{CC max}	Pin 6-7	16	V
		Pin 1-7	16	V
Lamp Driving Current	I _L		40	mA
Allowable Power Dissipation	P _{d max}	T _a ≤ 50°C	400	mW
Operating Temperature	T _{opr}		-20 to +70	°C
Storage Temperature	T _{stg}		-40 to +125	°C

Recommended Operating Conditions at Ta = 25°C

Parameter	Symbol	Conditions	Ratings	Unit
Recommended Supply Voltage	V _{CC}		6	V
Input Signal Voltage	V _i		100 to 200	mV

■ Any and all SANYO products described or contained herein do not have specifications that can handle applications that require extremely high levels of reliability, such as life-support systems, aircraft's control systems, or other applications whose failure can be reasonably expected to result in serious physical and/or material damage. Consult with your SANYO representative nearest you before using any SANYO products described or contained herein in such applications.

■ SANYO assumes no responsibility for equipment failures that result from using products at values that exceed, even momentarily, rated values (such as maximum ratings, operating condition ranges, or other parameters) listed in products specifications of any and all SANYO products described or contained herein.

SANYO Electric Co., Ltd. Semiconductor Company

TOKYO OFFICE Tokyo Bldg., 1-10, 1 Chome, Ueno, Taito-ku, TOKYO, 110-8534 JAPAN

LA3361

Operating Characteristics at $T_a = 25^\circ\text{C}$, $V_{CC}=6\text{V}$, $R_L=3.3\text{k}\Omega$, input=100mV, L+R=90%, pilot=10%, $f=1\text{kHz}$

Parameter	Symbol	Conditions	Ratings			Unit
			min	typ	max	
Quiescent Current	I_{CCO}			8.5	12.0	mA
Input Resistance	r_i		15	20		$\text{k}\Omega$
Channel Separation			35	45		dB
Total Harmonic Distortion	THD	stereo, sub		0.2	0.7	%
Output Voltage	V_O	$V_i=100\text{mV}$	66	85	115	mV
Channel Balance				0.5	1.5	dB
Lamp Turn-on Level	V_L	L+R=90%, pilot=10%		65		mV
Hysteresis	hy			3.5	6.0	dB
Capture Range	CR			± 2.5		%
Allowable Input Level	V_i	THD=2%		450		mV

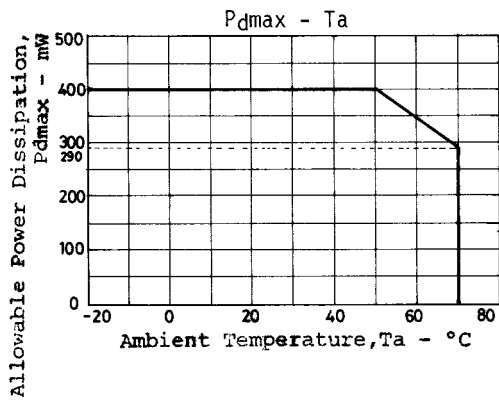

Equivalent Circuit Block Diagram and Peripheral Circuit

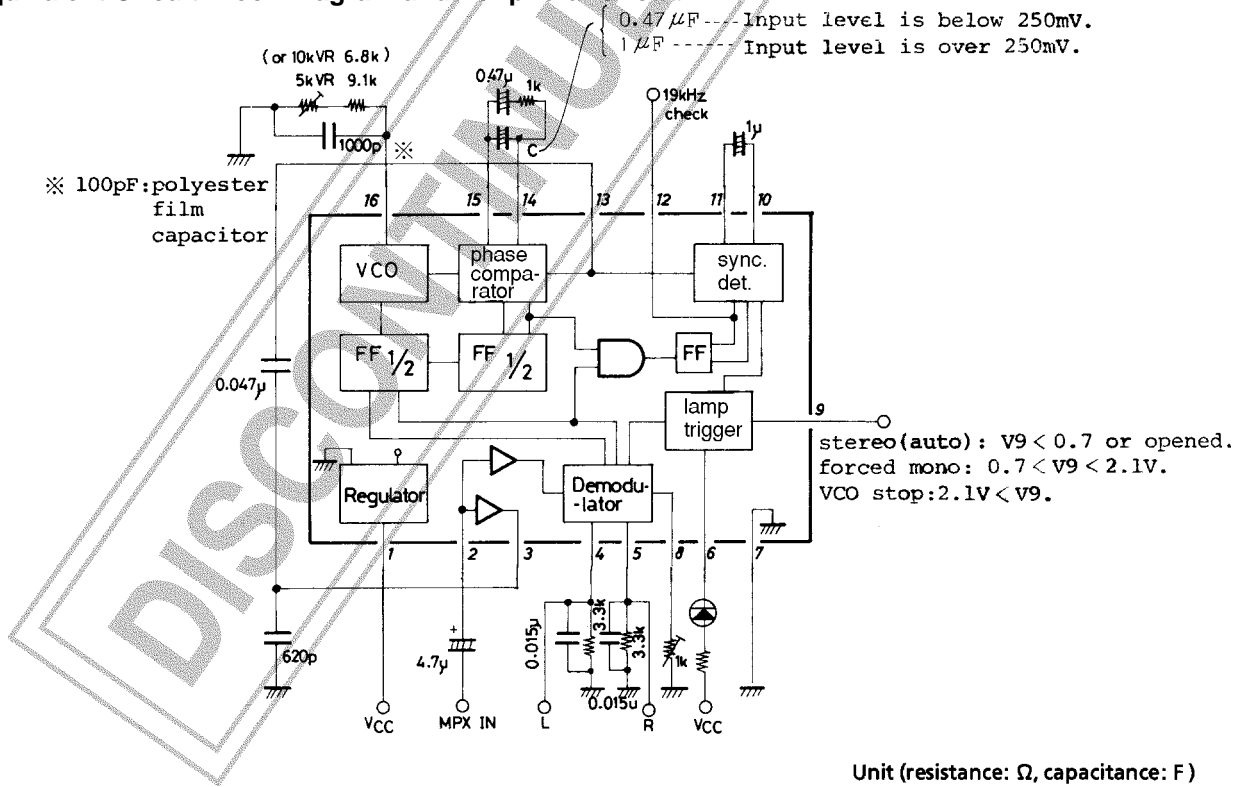

Sample Application Circuit

Unit (resistance: Ω , capacitance: F)

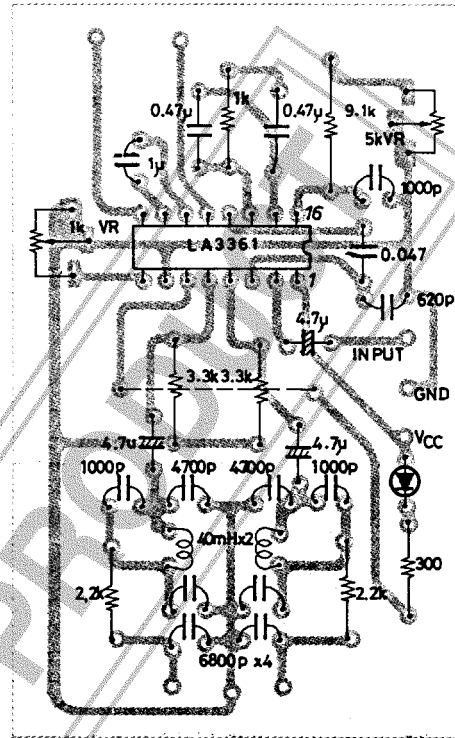
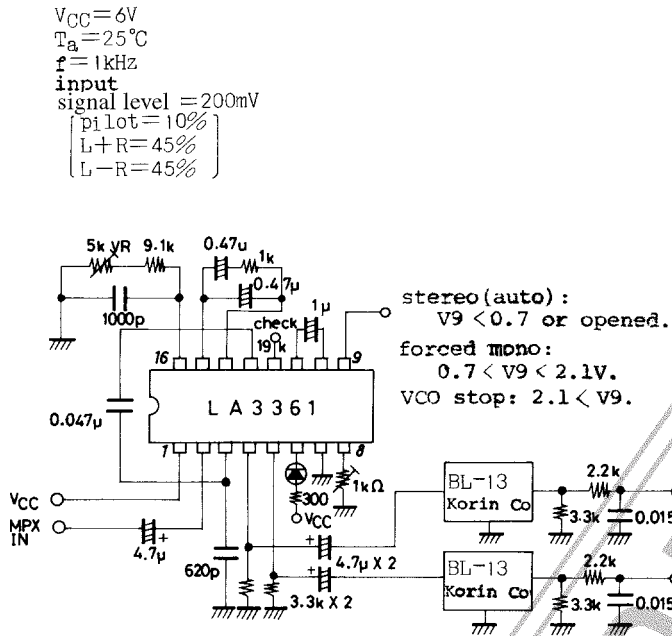

An Example of Printed Pattern
 Using LC Filter (Cu-foiled area, 50x82mm²)

DISCONTINUED

LA3361

Equivalent Circuit

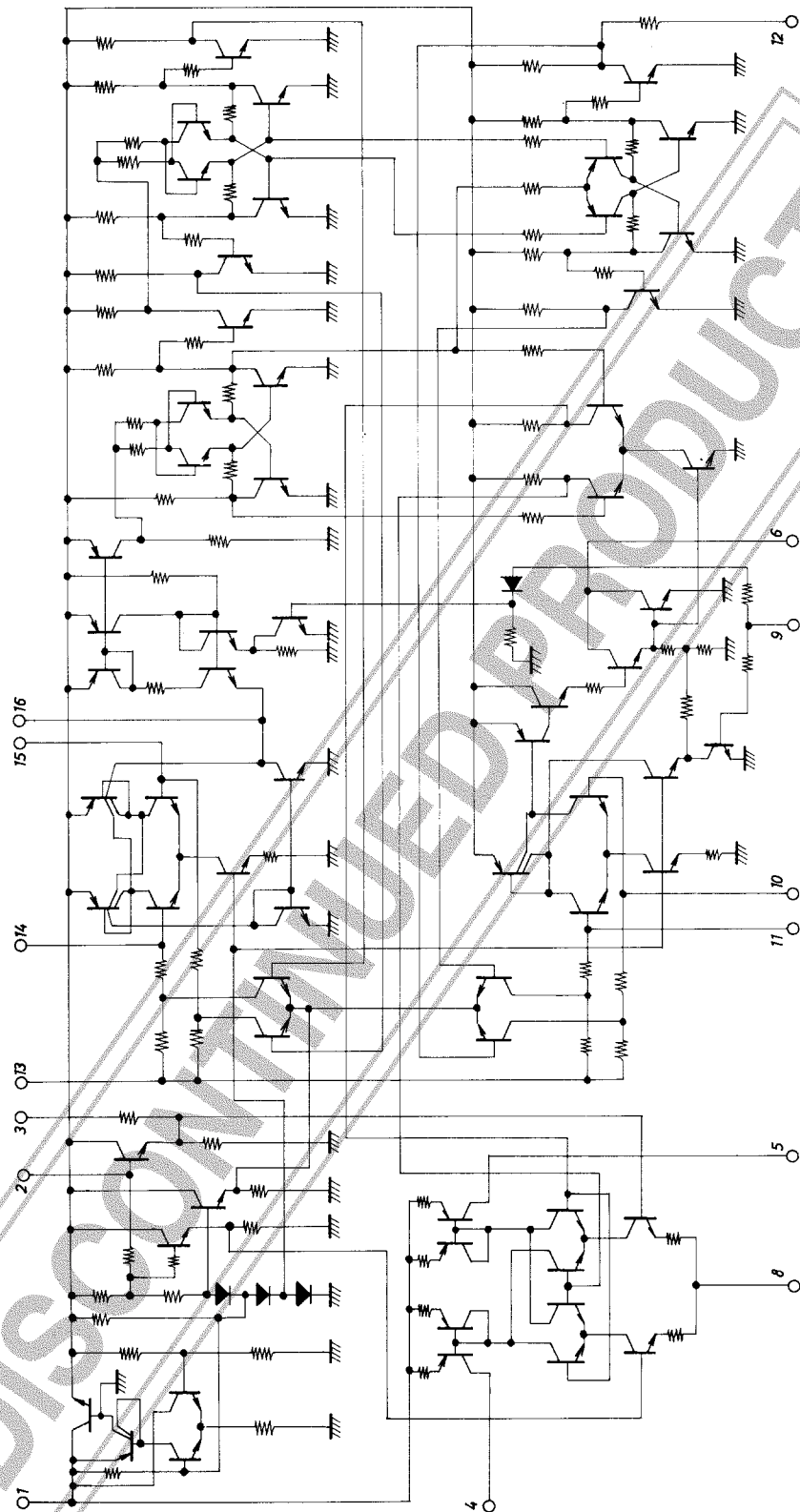

Examples of Low Pass Filter
(with Deemphasis, $R_L=3.3k\Omega$)

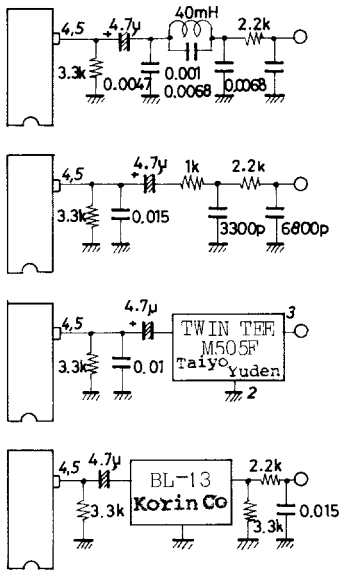

Unit (resistance: Ω , capacitance: F)

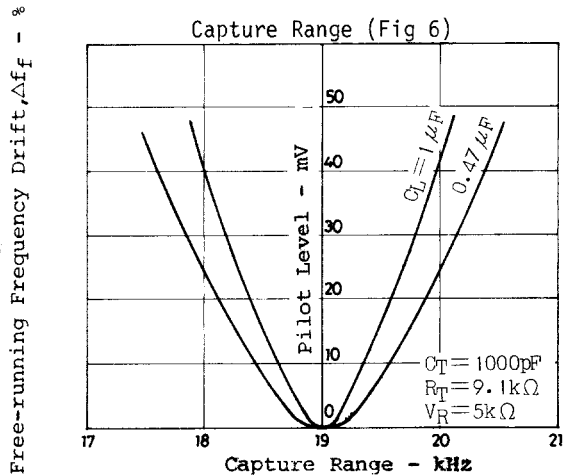
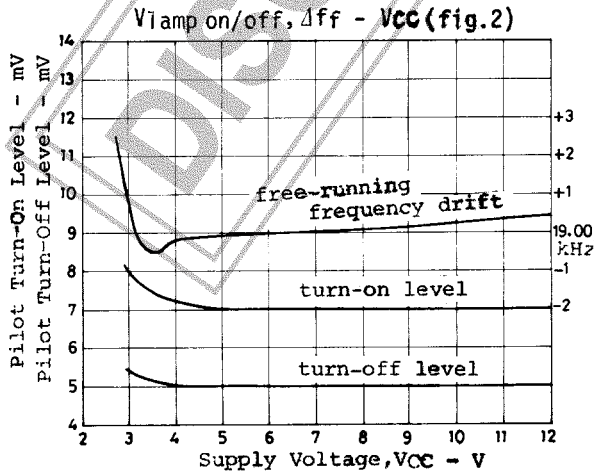
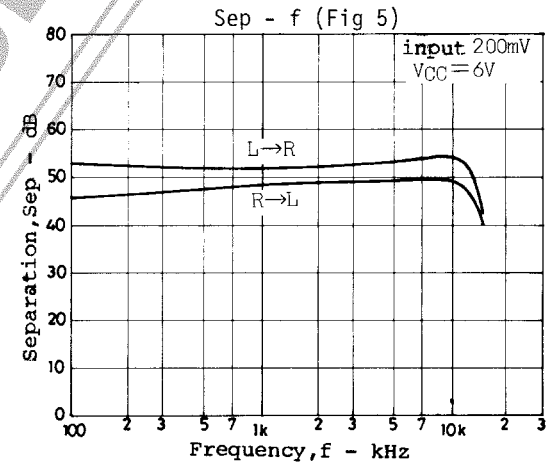
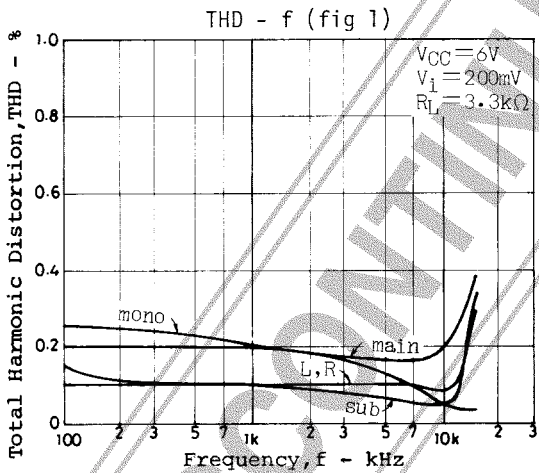
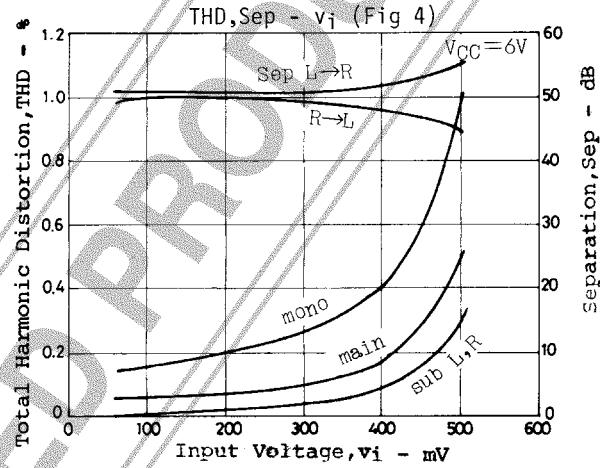
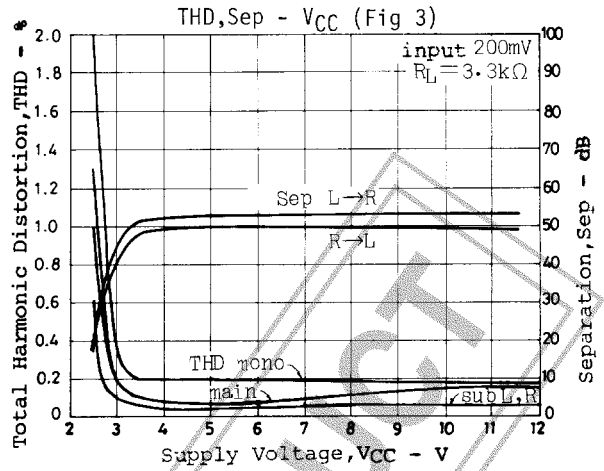

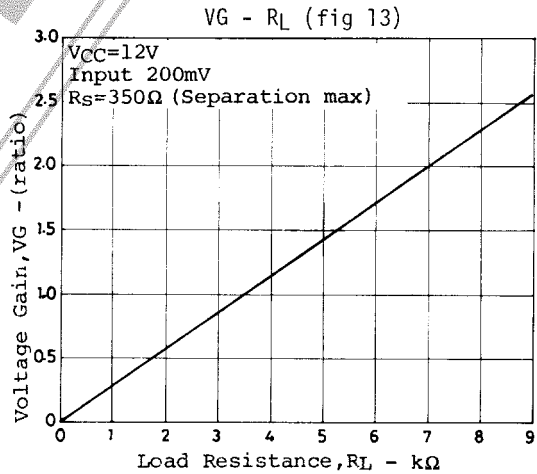
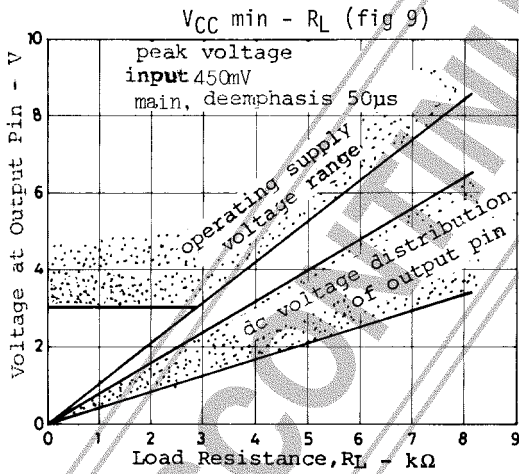
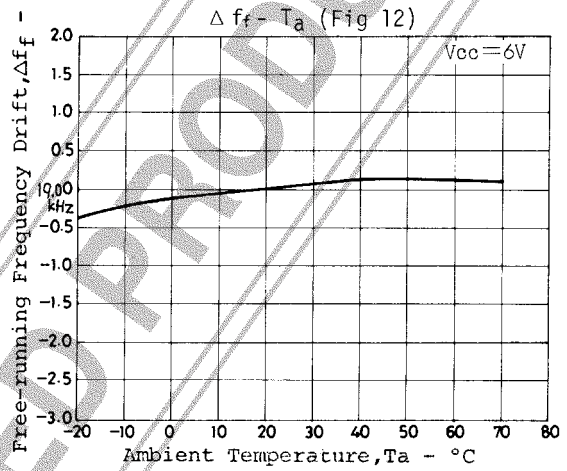
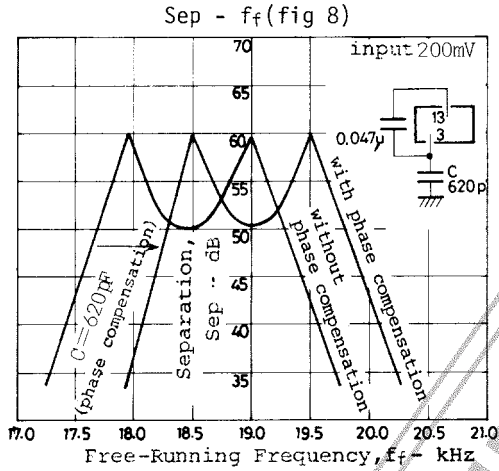
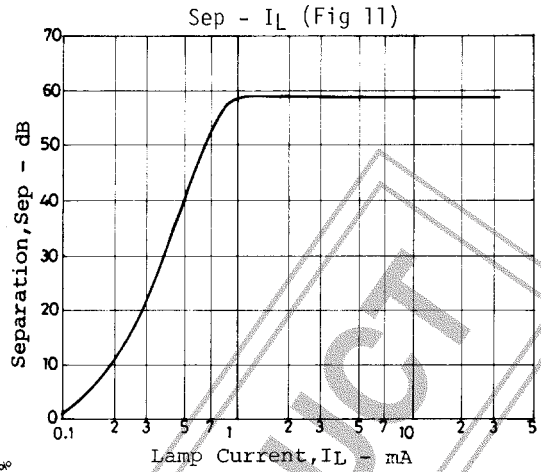
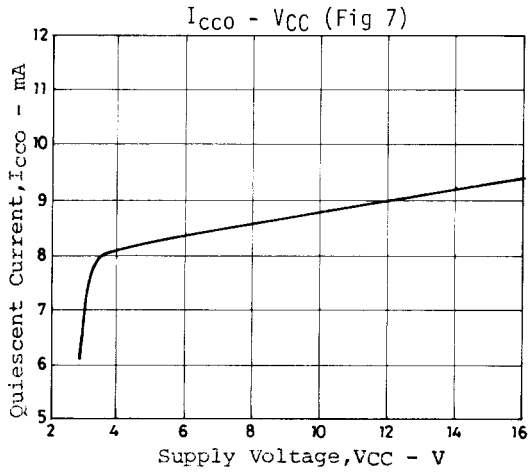

Schematic Diagram of Pin 9 Control (Fig.10)

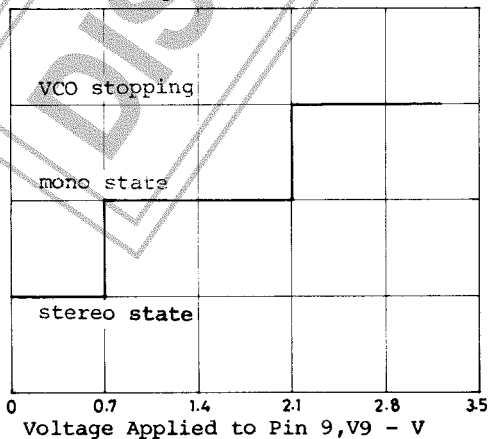

Proper cares in using the IC

(1) Pin 9-used control

Pin 9 is for stereo/monaural selection and VCO stop. When a voltage of less than 0.7V is applied to pin 9 or pin 9 is grounded or brought into the open state, the stereo (automatic) mode is entered. When a voltage of more than 2.1V is applied to pin 9, the VCO stops operating and the stereo indicator is prevented from malfunctioning. Therefore, no external measure against malfunction is required. When applying a voltage to pin 9, the following should be noted. An applied voltage of approximately 0.7V or 2.1V causes the internal transistors to enter the active region and hum or noise is liable to enter pin 9. Therefore, for example, the applied voltage must be set to an intermediate voltage such as 0V, 1.4V, 2.8V.

Schematic Diagram of Pin 9 Control (Fig.14)

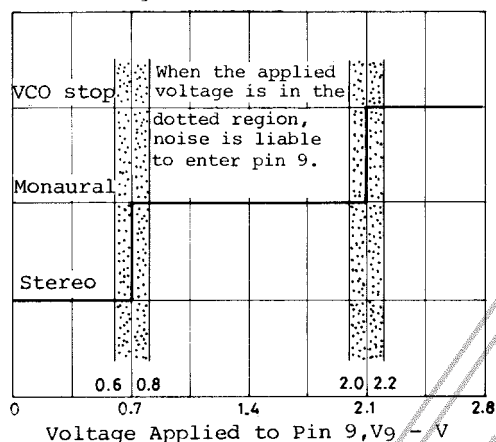

When the VCO stop mode caused by application of a voltage to pin 9 is released, the stereo indicator may be turned ON momentarily. This phenomenon is liable to occur if the value of the capacitor across pins 10 and 11 is large ($C_{10-11} > 2$ to $3\mu\text{F}$). The reason for this is that if the VCO stop mode and forced monaural mode are released simultaneously when the C_{10-11} is charged with the pin 10 side being at "H" level at the VCO stop mode, the trigger circuit is turned ON until the C_{10-11} is discharged. This can be prevented by making the release of the forced monaural mode a little later than that of the VCO stop mode. For this purpose, the C_9 is connected across pin 9 and GND as shown below so that the voltage on pin 9 drops slowly at the time of release.

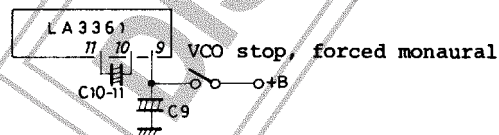

$C_9 > 2C_{10-11}$ is a rule-of thumb guide for the relation between C_9 and C_{10-11} which prevents the stereo indicator from being turned ON mistakenly.

(2) Loop filter capacitor C_{14-15}

When your set is designed with an input signal level of 250mV or greater, the C_{14-15} is $1\mu\text{F}$. The capture range tends to extend with the input level. When your set is designed with a high input signal level of 250mV or greater, your set is liable to be affected by high-frequency signals or noises. Therefore, the loop filter capacitor (across pins 14 and 15) should be made large to narrow the filter bandwidth. If $C_{14-15} = 1\mu\text{F}$ is used in your set with an input signal level of 250mV or greater, the capture range is made a little narrower and your set is hard to be affected by high-frequency signals.

(3) Phase compensation capacitor (See Fig. 8)

A capacitor of 620pF is connected across pin 3 and GND to compensate the phase lead caused by the decoupling capacitor across pins 3 and 13 and the phase shift caused by the PLL. If no phase compensation capacitor is connected, the center of the separation characteristic plotted against the free-running frequency is off 19.00kHz and the margin for the free-running frequency drift and adjustment error becomes narrow. Therefore, phase compensation should be done.

(4) Separation control

The separation control is done to provide a single or double hump response in the separation vs. free-running frequency characteristic as shown on next page.

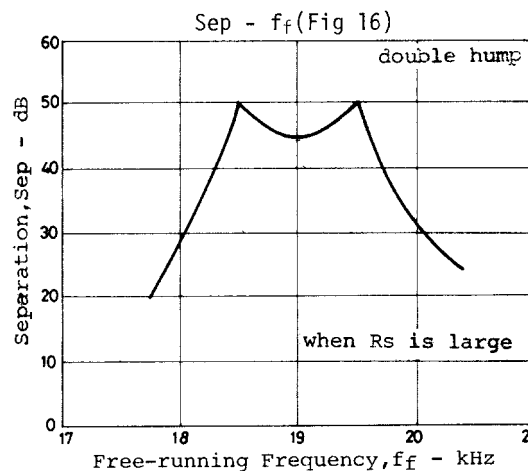
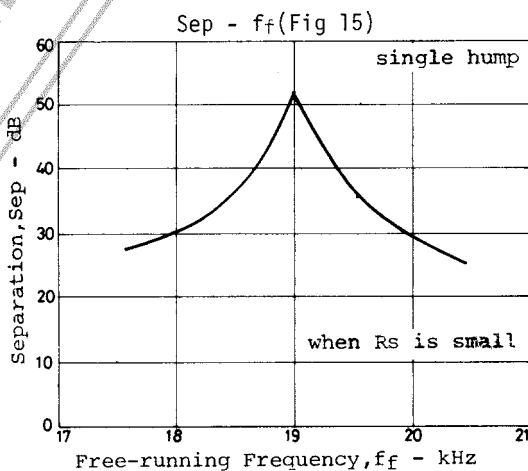

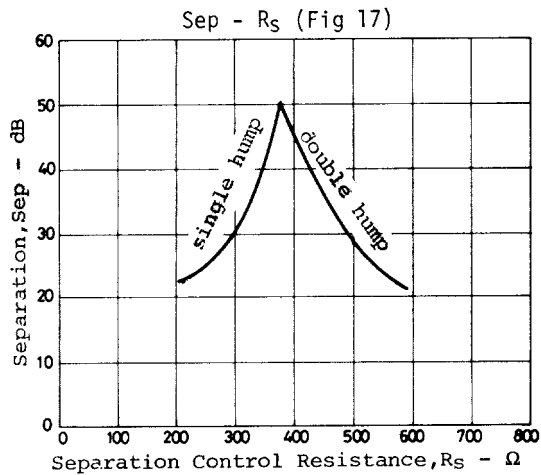

As is obvious from the figure shown above, the double hump response has more margin for the free-running frequency drift. The double hump response is obtained by setting separation control resistance R_S to a rather large value. The separation varies with R_S as shown above and has peak point at $R_S \approx 380k\Omega$ give the single hump response. Separation control should be done at a point a little off this peak on the double hump response side. For further details on separation, see the catalog of the LA3350.

- Specifications of any and all SANYO products described or contained herein stipulate the performance, characteristics, and functions of the described products in the independent state, and are not guarantees of the performance, characteristics, and functions of the described products as mounted in the customer's products or equipment. To verify symptoms and states that cannot be evaluated in an independent device, the customer should always evaluate and test devices mounted in the customer's products or equipment.
- SANYO Electric Co., Ltd. strives to supply high-quality high-reliability products. However, any and all semiconductor products fail with some probability. It is possible that these probabilistic failures could give rise to accidents or events that could endanger human lives, that could give rise to smoke or fire, or that could cause damage to other property. When designing equipment, adopt safety measures so that these kinds of accidents or events cannot occur. Such measures include but are not limited to protective circuits and error prevention circuits for safe design, redundant design, and structural design.
- In the event that any or all SANYO products (including technical data, services) described or contained herein are controlled under any of applicable local export control laws and regulations, such products must not be exported without obtaining the export license from the authorities concerned in accordance with the above law.
- No part of this publication may be reproduced or transmitted in any form or by any means, electronic or mechanical, including photocopying and recording, or any information storage or retrieval system, or otherwise, without the prior written permission of SANYO Electric Co., Ltd.
- Any and all information described or contained herein are subject to change without notice due to product/technology improvement, etc. When designing equipment, refer to the "Delivery Specification" for the SANYO product that you intend to use.
- Information (including circuit diagrams and circuit parameters) herein is for example only; it is not guaranteed for volume production. SANYO believes information herein is accurate and reliable, but no guarantees are made or implied regarding its use or any infringements of intellectual property rights or other rights of third parties.

This catalog provides information as of January, 2000. Specifications and information herein are subject to change without notice.