

8-BIT OTPROM FAMILY

(Am2764A, Am27128A, Am27256)

DISTINCTIVE CHARACTERISTICS

- Fast access times — as low as 200 ns
- Low-power dissipation
- Both interactive and new Flashrite* programming algorithms available
- Single +5-V power supply
- TTL-compatible inputs and outputs
- ±10% power-supply tolerance available
- Programming voltage—12.5 V

GENERAL DESCRIPTION

The Am2764A, Am27128A, and the Am27256 are One-Time Programmable Read-Only Memories (OTPRoms) and are organized as 8 bits per word. The plastic OTPROMs are ideal for volume production. First, because they can be inventoried unprogrammed and used with current-level software revisions; second, there is no window to be covered to prevent light from changing data —this could eliminate a manufacturing step and increase the reliability of the system; and third, they are compatible with auto insertion equipment. All standard OTPROMs offer access times of 250 ns, allowing operation with high-speed microprocessors without any Wait states. Some of AMD's OTPROMs have access times of as fast as 200 ns.

To eliminate bus contention on a multiple-bus microprocessor system, all AMD OTPROMs offer separate output enable (\overline{OE}) and chip enable (\overline{CE}) controls.

All signals are TTL levels, including programming signals. Bit locations may be programmed singly, in blocks, or at random. To reduce programming time, AMD's OTPROMs may be programmed using the Flashrite programming algorithm, which offers several fold improvement in programming time.

BLOCK DIAGRAM

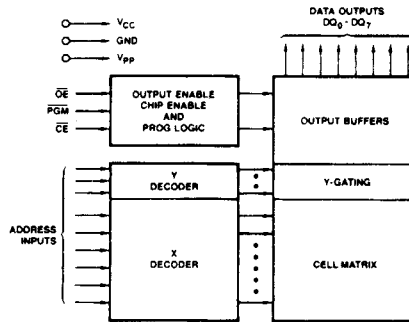

BD000231

PRODUCT SELECTOR GUIDE

Family Part No.	Am2764A, Am27128A, Am27256		
Ordering Part No.:			
±5% V _{CC} Tolerance	2764A-2 27128A-2 27256-2	2764A 27128A 27256	2764A-4 27128A-4 27256-4
±10% V _{CC} Tolerance	2764A-20 27128A-20 27256-20	2764A-25 27128A-25 27256-25	— — —
t _{ACC} (ns)	200	250	450
t _{CE} (ns)	200	250	450
t _{OE} (ns)	75	100	150

*Flashrite is a trademark of Advanced Micro Devices, Inc.

CONNECTION DIAGRAMS Top View

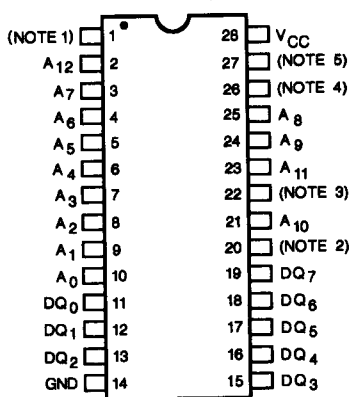

CD009420

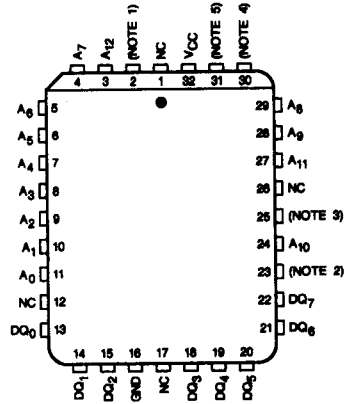

CD009770

Notes:

	Am2764A	Am27128A	Am27256
1	V _{PP}	V _{PP}	V _{PP}
2	\overline{CE}	\overline{CE}	\overline{CE}/PGM
3	\overline{OE}	\overline{OE}	\overline{OE}
4	NC	A ₁₃	A ₁₃
5	PGM	PGM	A ₁₄

LOGIC SYMBOLS

Am2764A

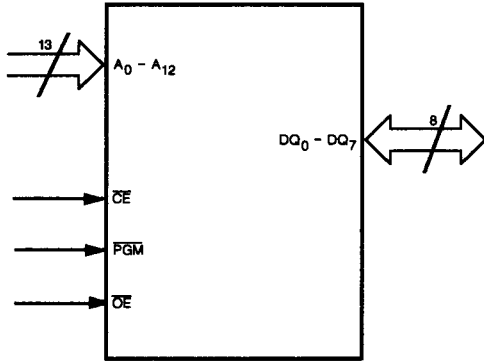

LS002360

Am27128A

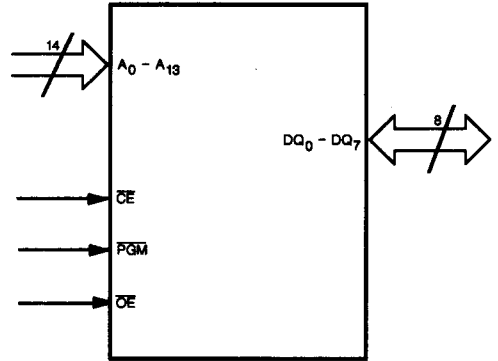

LS002370

Am27256

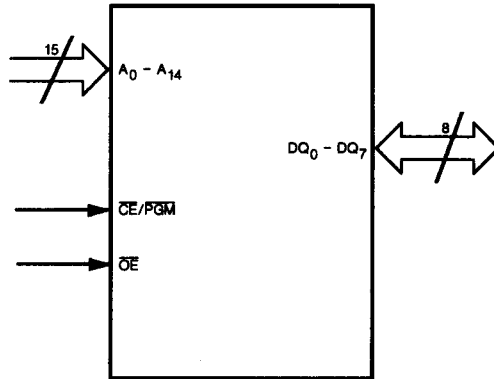

LS002380

ORDERING INFORMATION

Standard Products

AMD standard products are available in several packages and operating ranges. The order number (Valid Combination) is formed by a combination of:

- A. Device Number**
- B. Speed Option** (if applicable)
- C. Package Type**
- D. Temperature Range**
- E. Optional Processing**

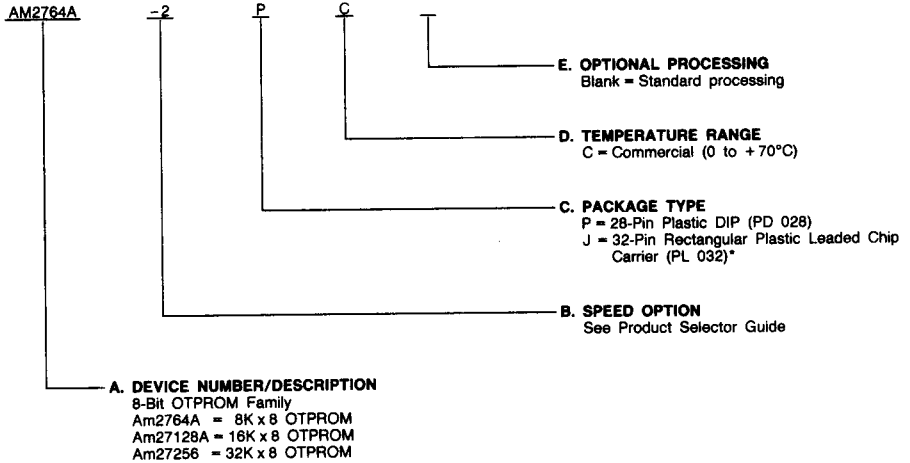

Valid Combinations

Valid Combinations list configurations planned to be supported in volume for this device. Consult the local AMD sales office to confirm availability of specific valid combinations, to check on newly released valid combinations, and to obtain additional data on AMD's standard military grade products.

*Preliminary. Subject to Change.

Valid Combinations	
± 5% V_{CC} Tolerance	
AM2764A-2	PC, JC
AM2764A	
AM2764A-4	
AM27128A-2	
AM27128A	
AM27128A-4	
AM27256-2	
AM27256	
AM27256-4	
± 10% V_{CC} Tolerance	
AM2764A-20	PC, JC
AM2764A-25	
AM27128A-20	
AM27128A-25	
AM27256-20	
AM27256-25	

FUNCTIONAL DESCRIPTION

Programming the 8-Bit OTPROMs

Upon delivery, or after each erasure, the OTPROM has all bits in the "1", or HIGH state. Zeros ("0s") are loaded into the OTPROM through the procedure of programming.

The programming mode is entered when a voltage greater than 12.0, but less than 13.3 V, is applied to the V_{PP} pin and \overline{PGM} ($\overline{CE}/\overline{PGM}$ for 256K) is low. The data to be programmed is applied 8 bits in parallel to the Data I/O (DQ_n) pins.

The flowcharts (Figures 1 and 2) show AMD's Flashrite programming and interactive programming algorithms. The Flashrite programming algorithm improves the programming time by several folds as compared to the interactive algorithm.

The AMD Flashrite programming algorithm reduces programming time by using initial 100 μ s pulses followed by a byte verification to determine whether the byte has been successfully programmed. If the data does not verify, an additional pulse is applied for a maximum of 25 pulses. This process is repeated while sequencing through each address of the OTPROM.

The Flashrite programming algorithm is programmed and verified at $V_{CC} = 6.25$ V and $V_{PP} = 13.0$ V. After the final address is completed, all bytes are compared to the original data with $V_{CC} = V_{PP} = 5.25$ V.

In addition to the Flashrite programming algorithm, OTPROMs are also compatible with AMD's interactive programming algorithm (see Figure 1).

The programming mode is entered when a voltage greater than 12.0 V but less than 13.3 V is applied to the V_{PP} pin.

The AMD interactive algorithm uses short (1 ms) program pulses by giving each address only as many pulses as necessary to program the data. After each pulse is applied to a given address, data in that address is verified. If the data does not verify, an additional pulse is applied for a maximum of 25 pulses. This process is repeated while sequencing through each address of the OTPROM. Programming and verification are done at $V_{CC} = 6.0$ V $\pm 5\%$.

The overprogram section of the algorithm programs the entire array by cycling through each address and applying an additional 2-ms program pulse. This section is done at $V_{CC} = 5.0$ V $\pm 5\%$.

After the final address is completed, the entire OTPROM is verified at $V_{CC} = 5.0$ V $\pm 5\%$.

Auto Select Mode

The Auto Select mode allows the reading out of a binary code from an OTPROM that will identify its manufacturer and type. This mode is intended for use by programming equipment for the purpose of automatically matching the device to be programmed with its corresponding programming algorithm. This mode is functional in the 25°C $\pm 5^\circ$ C ambient-temperature range required when programming the OTPROMs.

To activate this mode, the programming equipment must force 12.0 V to ± 0.5 V on address line A_0 . Two identifier bytes may then be sequenced from the device outputs by toggling address line A_0 from V_{IL} to V_{IH} . All other address lines must be held at V_{IL} during Auto Select mode.

Byte 0 ($A_0 = V_{IL}$, $DQ_0 - DQ_7$) represents the manufacturer code, and byte 1 ($A_0 = V_{IH}$, $DQ_0 - DQ_7$), the device identifier code. These identifier bytes are given in Table 2. All identifiers for manufacturer and device codes will possess odd parity,

with the most significant bit (MSB), DQ_7 , defined as the parity bit.

Read Mode

AMD OTPROMs have two control functions, both of which must be logically satisfied in order to obtain data at the outputs. Chip Enable (\overline{CE}) is the power control and should be used for device selection. Output Enable (\overline{OE}) is the output control and should be used to gate data to the output pins, independent of device selection. Assuming that addresses are stable, address access time (t_{ACC}) is equal to the delay from \overline{CE} to output (t_{CE}). Data is available at the outputs t_{OE} after the falling edge of \overline{OE} , assuming that \overline{CE} has been LOW and addresses have been stable for at least $t_{ACC} - t_{OE}$.

Standby Mode

AMD OTPROMs have a standby mode which reduces the active power dissipation up to 80%. The OTPROM is placed in the standby mode by applying a TTL HIGH signal to the \overline{CE} input. When in standby mode, the outputs are in a high-impedance state, independent of the \overline{OE} input.

Output OR-Tieing

To accommodate multiple memory connections, a two-line control function is provided to allow for: 1) low-memory power dissipation, and 2) assurance that output-bus contention will not occur.

It is recommended that \overline{CE} be decoded and used as the primary device-selecting function, while \overline{OE} be made a common connection to all devices in the array, and connected to the Read line from the system control bus. This assures that all deselected memory devices are in their low-power standby mode and that the output pins are only active when data is desired from a particular memory device.

Program Inhibit

Programming of multiple OTPROMs in parallel with different data is also easily accomplished. Except for \overline{CE} or \overline{PGM} , all like inputs (including \overline{OE} and V_{PP}) of the parallel OTPROMs may be common. A TTL LOW-level program pulse applied to the \overline{PGM} ($\overline{CE}/\overline{PGM}$ for 256K) input with V_{PP} between 12.75 V and 13.25 V and \overline{CE} LOW, will program that OTPROM. A HIGH-level \overline{CE} or \overline{PGM} input inhibits the other OTPROMs from being programmed.

Program Verify

A verify should be performed on the programmed bits to determine that they were correctly programmed.

Data for all the OTPROMs should be verified t_{OE} after the falling edge of \overline{OE} , V_{PP} must be between 12.75 V and 13.25 V for all OTPROMs.

System Applications

During the switch between active and standby conditions, transient current peaks are produced on the rising and falling edges of Chip Enable. The magnitude of these transient current peaks is dependent on the output capacitance loading of the device. A 0.1- μ F ceramic capacitor (high-frequency, low-inherent inductance) should be used on each device between V_{CC} and GND to minimize transient effects. In addition, to overcome the voltage drop caused by the inductive effects of the printed circuit-board traces on OTPROM arrays, a 4.7- μ F bulk electrolytic capacitor should be used between V_{CC} and GND for each eight devices. The location of the capacitor should be close to where the power supply is connected to the array.

FUNCTION TABLES

TABLE 1. Am2764A and 27128A MODE SELECT

MODE	PINS						OUTPUTS
	\overline{CE}	\overline{OE}	\overline{PGM}	A_9	V_{PP}		
Read	L	L	H	X	V_{CC}	DOUT	
Output Disable	L	H	H	X	V_{CC}	Hi-Z	
Standby	H	X	X	X	V_{CC}	Hi-Z	
Program	L	X	L	X	V_{PP}	DIN	
Program Verify	L	L	H	X	V_{PP}	DOUT	
Program Inhibit	H	X	X	X	V_{PP}	Hi-Z	
Auto Select	L	L	H	V_H	V_{CC}	Code	

TABLE 2. Am27256 MODE SELECT

MODE	PINS						OUTPUTS
	$\overline{CE}/\overline{PGM}$	\overline{OE}	A_9	V_{PP}			
Read	L	L	X	V_{CC}	DOUT		
Output Disable	L	H	X	V_{CC}	Hi-Z		
Standby	H	X	X	V_{CC}	Hi-Z		
Program	L	H	X	V_{PP}	DIN		
Program Verify	H	L	X	V_{PP}	DOUT		
Program Inhibit	H	H	X	V_{PP}	Hi-Z		
Auto Select	L	L	V_H	V_{CC}	Code		

Key: L = LOW

H = HIGH

X = Can be either LOW or HIGH

$V_H = 12.0 \text{ V} \pm 0.5 \text{ V}$

ABSOLUTE MAXIMUM RATINGS

Storage Temperature -65 to +150°C
 Ambient Temperature with Power Applied . -65 to +135°C
 Supply Voltage
 with respect to Ground
 on all Inputs except A_9 and V_{pp} +6.50 to -0.6 V
 on A_9 +13.50 to -0.6 V
 on V_{pp} +13.50 to -0.6 V

Stresses above those listed under ABSOLUTE MAXIMUM RATINGS may cause permanent device failure. Functionality at or above these limits is not implied. Exposure to absolute maximum ratings for extended periods may affect device reliability.

OPERATING RANGES

Commercial (C) Devices

Temperature (T_C) 0 to +70°C
 Supply Voltage (V_{CC}) (Notes 1 & 2)

- Notes: 1. For -2, blank, and -4 versions, $V_{CC} = +4.75$ to +5.25 V.
 2. For -20 and -25 versions, $V_{CC} = +4.50$ to +5.50 V.

Operating ranges define those limits between which the functionality of the device is guaranteed.

DC CHARACTERISTICS over operating range unless otherwise specified (Notes 1, 2, & 4)*

Parameter Symbol	Parameter Description	Test Conditions	Min.	Max.	Units
V_{OH}	Output HIGH Voltage	$I_{OH} = -400 \mu A$	2.4		V
V_{OL}	Output LOW Voltage	$I_{OL} = 2.1 \text{ mA}$		0.45	V
V_{IH}	Input HIGH Voltage		2.0	$V_{CC} + 1$	V
V_{IL}	Input LOW Voltage		-0.1	+0.8	V
I_{LI}	Input Load Current	$V_{IN} = 0$ to +5.5 V		10.0	μA
I_{LO}	Output Leakage Current	$V_{OUT} = 0$ to -5.5 V		10.0	μA
I_{CC1}	V_{CC} Standby Current (Note 6)	$\overline{CE} = V_{IH}$, $\overline{OE} = V_{IL}$		25	mA
I_{CC2}	V_{CC} Active Current for Am2764A	$\overline{OE} = \overline{CE} = V_{IL}$		75	mA
	V_{CC} Active Current for Am27128A and Am27256			100	
I_{PP1}	V_{pp} Read Current (Notes 1 & 5)	$V_{PP} = 5.5 \text{ V}$		5	mA

Notes: See notes following the Capacitance table on next page.

*See the last page of this spec for Group A Subgroup Testing information.

CAPACITANCE (Notes 2 & 3)

Parameter Symbol	Parameter Description	Test Conditions	Typ.	Max.	Units
C_{IN}	Input Capacitance	$V_{IN} = 0\text{ V}$	4	7	pF
C_{OUT}	Output Capacitance	$V_{OUT} = 0\text{ V}$	8	12	pF

- Notes: 1. V_{CC} must be applied simultaneously or before V_{pp} , and removed simultaneously or after V_{CC} .
 2. Typical values are for nominal supply voltages.
 3. This parameter is only sampled and not 100% tested.
 4. Caution: The OTPROMs must not be removed from or inserted into a socket or board when V_{pp} or V_{CC} is applied.
 5. V_{pp} may be connected to V_{CC} directly except during programming. The supply would then be the sum of I_{CC} and I_{pp} .
 6. I_{CC1} Max. is 40 mA for -4 devices.

KEY TO SWITCHING WAVEFORMS

WAVEFORM	INPUTS	OUTPUTS
	MUST BE STEADY	WILL BE STEADY
	MAY CHANGE FROM H TO L	WILL BE CHANGING FROM H TO L
	MAY CHANGE FROM L TO H	WILL BE CHANGING FROM L TO H
	DON'T CARE: ANY CHANGE PERMITTED	CHANGING: STATE UNKNOWN
	DOES NOT APPLY	CENTER LINE IS HIGH IMPEDANCE "OFF" STATE

KS000010

SWITCHING TEST CIRCUITS

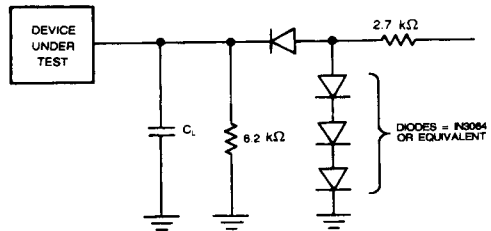

TC003191

SWITCHING TEST WAVEFORMS

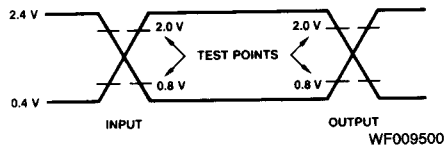

WF009500

AC Testing: Inputs are driven at 2.4 V for a logic "1" and 0.45 V for a logic "0". Input pulse rise and fall times are $\leq 20\text{ ns}$.

SWITCHING CHARACTERISTICS over operating range unless otherwise specified* (Notes 1 & 3)

No.	Parameter Symbol	Parameter Description	Test Conditions (Note 4)	-2, -20		Blank, -25		-4		Units
				Min.	Max.	Min.	Max.	Min.	Max.	
1	t_{ACC}	Address to Output Delay	$\overline{CE} = \overline{OE} = V_{IL}$		200		250		450	ns
2	t_{CE}	Chip Enable to Output Delay			200		250		450	ns
3	t_{OE}	Output Enable to Output Delay			75		100		150	ns
4	t_{DF} (Note 2)	Output Enable HIGH to Output Float		0	60	0	60	0	80	ns
5	t_{OH} (Note 2)	Output Hold from Addresses, \overline{CE} , or \overline{OE} , whichever occurred first		0		0		0		ns

- Notes: 1. V_{CC} must be applied simultaneously or before V_{pp} , and removed simultaneously or after V_{pp} . This parameter is only sampled and not 100% tested.
 2. Caution: The AMD 8-bit OTPROM Family must not be removed from or inserted into a socket or board when V_{pp} or V_{CC} is applied.
 3. Output Load: 1 TTL gate and $C_L = 100$ pF, Input Rise and Fall Times: ≤ 20 ns, Input Pulse Levels: 0.45 to 2.4 V, Timing Measurement Reference Level — Inputs: 1 V and 2 V Outputs: 0.8 V and 2 V.

*See the last page of this spec for Group A Subgroup Testing information.

SWITCHING WAVEFORMS

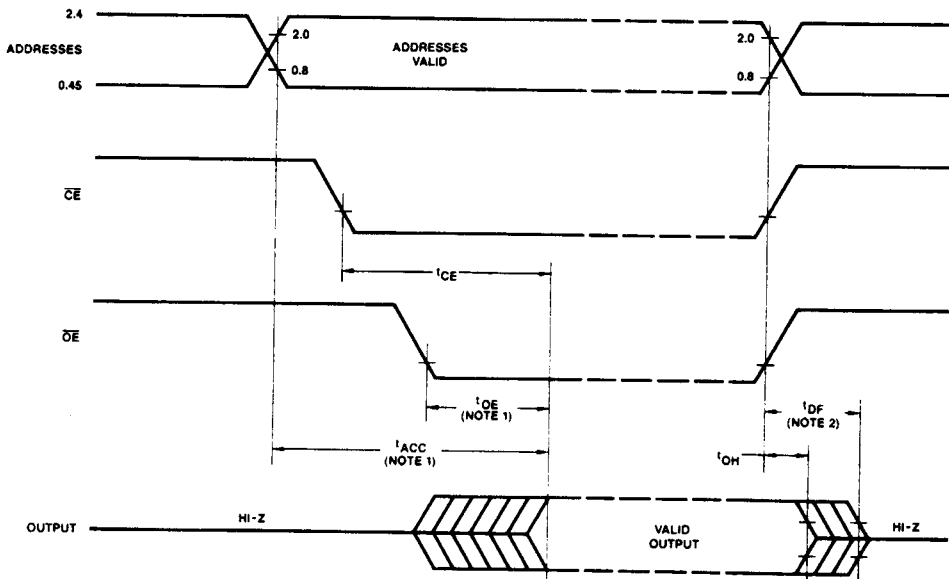

WF001321

- Notes: 1. \overline{OE} may be delayed up to $t_{ACC} - t_{OE}$ after the falling edge of \overline{OE} without impact on t_{ACC} .
 2. t_{DF} is specified from \overline{OE} or \overline{CE} , whichever occurs first.

PROGRAMMING

This section covers Identifier bytes, Interactive Programming Flowchart, and Programming DC and AC Switching Programming Characteristics.

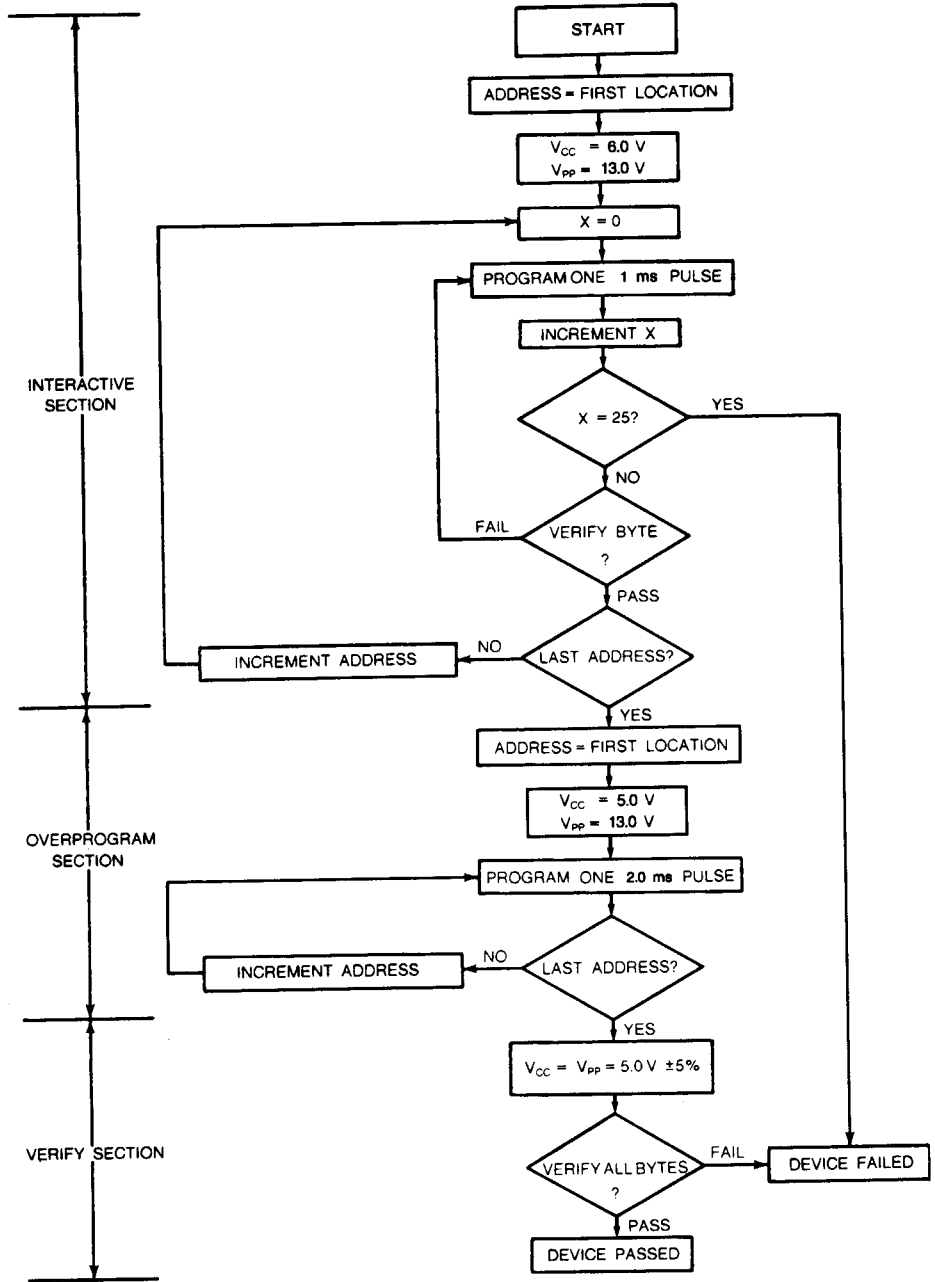

PF000251

Figure 1. Interactive Programming Flow Chart

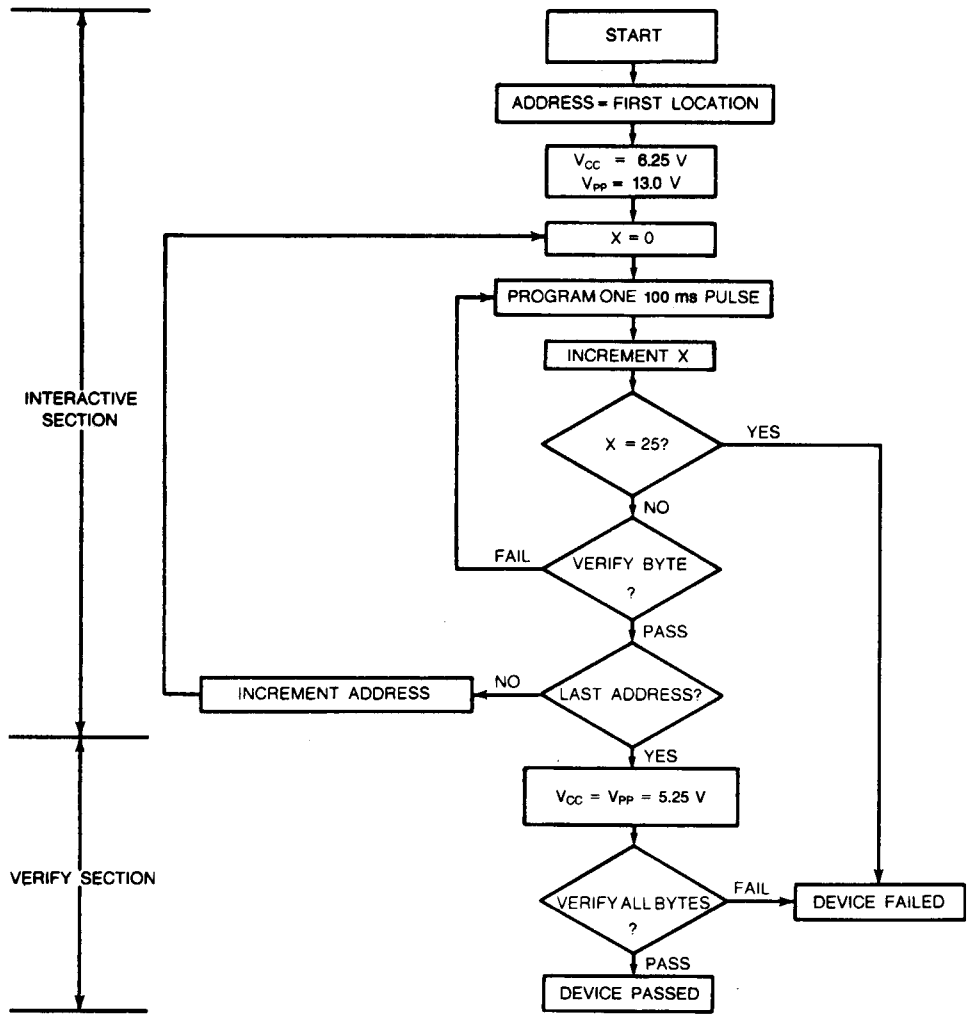

PF001725

Figure 2. Flashrite Programming Flow Chart

TABLE 3. IDENTIFIER BYTES

Identifier	Pins										Hex Data
	A ₀	DQ ₇	DQ ₆	DQ ₅	DQ ₄	DQ ₃	DQ ₂	DQ ₁	DQ ₀		
Manufacturer Code	V _{IL}	0	0	0	0	0	0	0	0	1	01
Am2764A Device Code	V _{IH}	0	0	0	0	1	0	0	0	0	08
Am27128A Device Code	V _{IH}	1	0	0	0	1	0	0	1	89	
Am27256 Device Code	V _{IH}	0	0	0	0	0	1	0	0	04	

- Notes: 1. A₉ = 12.0 V ±0.5 V
 2. All other Address Lines = $\overline{CE} = \overline{OE} = V_{IL}$
 3. For Am2764A, PGM = V_{IH}
 4. For Am27256, A₁₄ = Don't Care

INTERACTIVE PROGRAMMING ALGORITHM DC PROGRAMMING CHARACTERISTICS

Parameter Symbol	Parameter Description		Test Conditions	Min.	Max.	Units
I _{L1}	Input Current (All Inputs)		V _{IN} = V _{IL} or V _{IH}		10.0	μA
V _{IL}	Input LOW Level (All Inputs)			-0.1	0.8	V
V _{IH}	Input HIGH Level			2.0	V _{CC} + 1	V
V _{OL}	Output LOW Voltage during Verify		I _{OL} = 2.1 mA		.45	V
V _{OH}	Output LOW Voltage during Verify		I _{OH} = -400 μA	2.4		V
I _{CC2}	V _{CC} Supply Current (Program and Verify)	For Am2764A			75	mA
		For Am27128A and Am27256			100	
I _{PP3}	V _{PP} Supply Current (Program)		$\overline{CE} = V_{IL} =$ PGM = \overline{CE}/PGM		30	mA
V _{ID}	A ₉ Auto-Select Voltage			11.5	12.5	V
V _{PP}	Interactive Programming Algorithm			12.0	13.3	V
	Flashrite Programming Algorithm			12.75	13.25	V
V _{CC}	Interactive Programming Algorithm			5.75	6.25	V
	Flashrite Programming Algorithm			6.0	6.5	V

PROGRAMMING AC CHARACTERISTICS

(Notes 1, 2, 3, and 4)

No.	Parameter Symbols	Parameter Description	Min.	Max.	Units
1	t _{AS}	Address Setup Time	2		μs
2	t _{OES}	$\overline{\text{OE}}$ Setup Time	2		μs
3	t _{DS}	Data Setup Time	2		μs
4	t _{AH}	Address Hold Time	2		μs
5	t _{DH}	Data Hold Time	2		μs
6	t _{DF}	Chip Enable to Output Float Delay	0	130	μs
7	t _{VPS}	V _{pp} Setup Time	2.0		μs
8	t _{VCS}	V _{CC} Setup Time	2		μs
9	t _{PW}	PGM Initial Program Pulse Width (Interactive)	.95	1.05	ms
		PGM Initial Program Pulse Width (Flashrite)	95	105	μs
10	t _{OPW}	PGM Overprogram Pulse Width (Note 3,5)	1.95	2.05	ms
11	t _{CES}	$\overline{\text{CE}}$ Setup Time	2		μs
12	t _{OE}	Data Valid from $\overline{\text{OE}}$		150	ns

- Notes: 1. T_A = +25°C ±5°C; see DC Programming Characteristics for V_{CC} and V_{pp} voltages.
 2. V_{CC} must be applied simultaneously or before V_{pp} and removed simultaneously or after V_{pp}.
 3. When programming the OTPROM family, a 0.1-μF capacitor is required across V_{pp} and ground to suppress spurious voltage transients which may damage the device.
 4. Programming characteristics are guidelines which must be followed. They are not 100% tested to worst-case limits.
 5. Interactive programming algorithm only.

INTERACTIVE PROGRAMMING ALGORITHM WAVEFORMS

Am2764A and Am27128A (Notes 1 and 2)

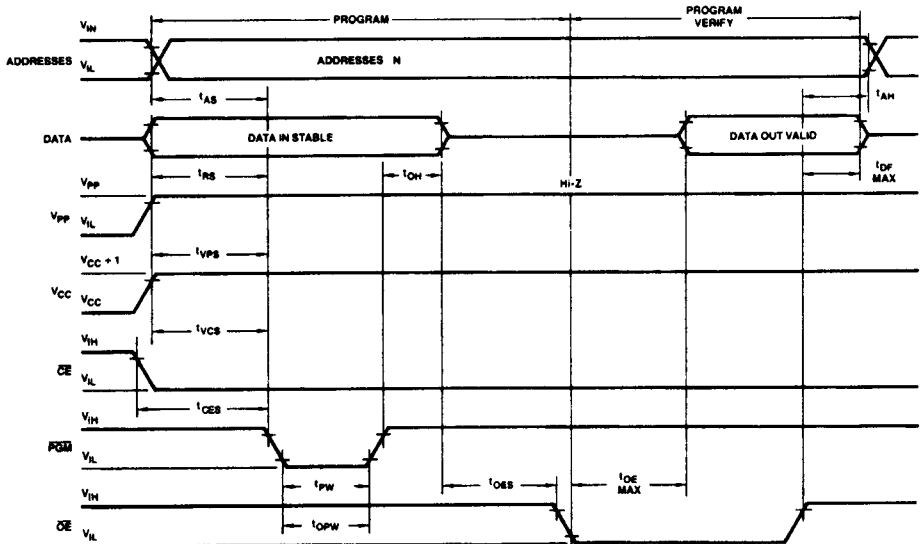

WF00052

Am27256 (Notes 1 and 3)

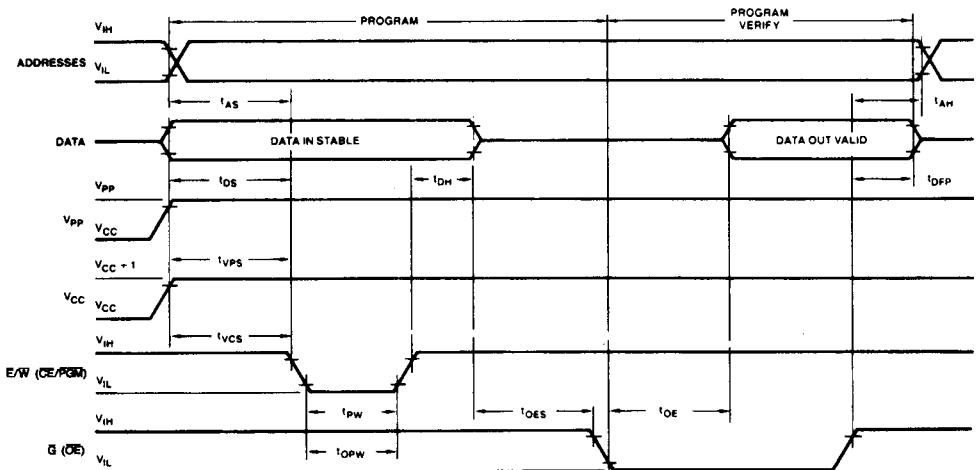

WF000582

- Notes: 1. The input timing reference level is 0.8 V for V_{IL} and 2 V for V_{IH} .
 2. t_{OE} and t_{DF} are characteristics of the device, but must be accommodated by the programmer.
 3. t_{OE} and t_{DFP} are characteristics of the device, but must be accommodated by the programmer.

GROUP A SUBGROUP TESTING

DC CHARACTERISTICS

Parameter Symbol	Subgroups*
V _{OH}	1, 2, 3
V _{OL}	1, 2, 3
V _{IH}	1, 2, 3
V _{IL}	1, 2, 3
I _{LI}	1, 2, 3
I _{LO}	1, 2, 3
I _{CC1}	1, 2, 3
I _{CC2}	1, 2, 3
I _{PP1}	1, 2, 3
I _{PP2}	1, 2, 3
C _{IN}	4
C _{OUT}	4
C _{IN2}	4
C _{IN3}	4

*For DC Programming Characteristics, only Subgroup 1 applies.

SWITCHING CHARACTERISTICS

No.	Parameter Symbol	Subgroups
1	t _{ACC}	9, 10, 11
2	t _{CE}	9, 10, 11
3	t _{OE}	9, 10, 11
4	t _{DF}	9
5	t _{OH}	9

MILITARY BURN-IN

Military burn-in is in accordance with the current revision of MIL-STD-883, Test Method 1015, Conditions A through E. Test conditions are selected at AMD's option.