



EN62368-1



TPTC004



IEC62368-1



Features

- Built-in active PFC function
- High efficiency up to 96%
- Fanless design, cooling by free air convection
- Aluminum case and filling with heat-conducted glue
- Withstand 10G vibration test
- -40 ~ +70°C wide operating range
- Charger for lead-acid batteries (flooded, Gel and AGM) and Li-ion batteries (lithium iron and lithium manganese)
- Built-in default 2/3 stage charging curves and programmable curve
- Built-in PMBus protocol / Optional CANBus protocol
- Output voltage and constant current level programmable
- Protections: Short circuit / Overload / Over voltage / Over temperature
- Built-in remote ON-OFF control
- DC OK active signal
- LED indicator for power on
- Optional wiring type with IP67 rating
- 6 years warranty

Certificates

- Safety: UL/EN62368-1
- EMC: EN 55032 / 55024

Applications

- Industrial automation machinery
- Industrial control system
- Mechanical and electrical equipment
- Electronic instruments, equipments or apparatus
- Household appliances

Description

HEP-1000 is a 1000W industrial AC/DC power supply featuring the outstanding capability to operate under highly humid, dusty, oily, and high-vibration harsh environment. The entire series is housed with the aluminum case and fully potted with heat-conducted silicone. Adopting the full range 90~305VAC input, the entire series provides an output voltage line of 24V, 48V and 100V. In addition to the high efficiency up to 96%, that the whole series operates from -40°C ~ 70°C under air convection without fan. HEP-1000 has the complete protection functions and 10G anti-vibration capability; It is complied with the international safety regulations such as TUV EN62368-1 UL62368-1, and the design refers to EN61558-1 and EN60335-1. HEP-1000 series serves as a high performance power supply solution for various industrial applications.

Model Encoding

HEP - 1000 - 24

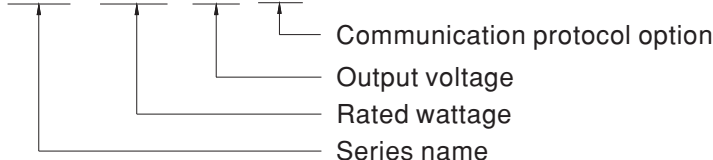

Type	Communication Protocol	Note
Blank	PMBus protocol	In Stock
CAN	CANBus protocol	By request

SPECIFICATION FOR POWER SUPPLY

MODEL		HEP-1000-24	HEP-1000-48	HEP-1000-100	
OUTPUT	DC VOLTAGE	24V	48V	100V	
	RATED CURRENT	42A	21A	10A	
	RATED POWER	1008W	1008W	1000W	
	RIPPLE & NOISE (max.) Note.2	200mVp-p	250mVp-p	500mVp-p	
	VOLTAGE ADJ. RANGE	By built-in potentiometer, SVR			
		24 ~ 30V	48 ~ 60V	100 ~ 125V	
	VOLTAGE TOLERANCE Note.3	± 1.0%	± 1.0%	± 1.0%	
	LINE REGULATION	± 0.5%	± 0.5%	± 0.5%	
	LOAD REGULATION	± 0.5%	± 0.5%	± 0.5%	
SETUP, RISE TIME	1800ms, 80ms at full load 230VAC /115VAC				
HOLD UP TIME (Typ.)	16ms / 230VAC at 75% load 12ms / 230VAC at full load				
INPUT	VOLTAGE RANGE Note.4	90 ~ 305VAC 250 ~ 431VDC			
	FREQUENCY RANGE	47 ~ 63Hz			
	POWER FACTOR (Typ.)	PF>0.99/115VAC, PF>0.95/230VAC, PF>0.93/277VAC at full load			
	EFFICIENCY (Typ.)	95%	96%	96%	
	AC CURRENT (Typ.)	10.1A / 115VAC	5.3A / 230VAC	4.5A / 277VAC	
	INRUSH CURRENT(Typ.)	Cold start 40A at 230VAC			
	LEAKAGE CURRENT	<0.75mA / 240VAC			
PROTECTION	OVERLOAD	105~125% rated output power Protection type : Constant current limiting, unit will shutdown after 5 sec, re-power on to recover.			
	SHORT CIRCUIT	Constant current limiting, unit will shutdown after 5 sec, re-power on to recover.			
	OVER VOLTAGE	30 ~ 35V	60 ~ 70V	125 ~ 145V	
		Protection type : Shut down O/P voltage, re-power on to recover			
OVER TEMPERATURE	Protection type : Shut down O/P voltage, recovers automatically after temperature goes down				
FUNCTION	OUTPUT VOLTAGE PROGRAMMABLE(PV) Note.5	Adjustment of output voltage is allowable to 50 ~ 125% of nominal output voltage Please refer to the Function Manual.			
	OUTPUT CURRENT PROGRAMMABLE(PC) Note.5	Adjustment of constant current level is allowable to 20 ~ 100% of rated current. Please refer to the Function Manual.			
	REMOTE ON/OFF CONTROL	Power ON : Short circuit Power OFF : Open circuit			
	AUXILIARY POWER	12V @ 0.5A tolerance ±10%, ripple=150mVp-p			
	DC-OK SIGNAL	The TTL signal out, PSU turn on = 4.4 ~ 5.5V ; PSU turn off = -0.5 ~ 0.5V. Please refer to the Function Manual.			
ENVIRONMENT	WORKING TEMP.	-40 ~ +70°C (Refer to "Derating Curve")			
	WORKING HUMIDITY	20 ~ 95% RH non-condensing			
	STORAGE TEMP., HUMIDITY	-40 ~ +80°C, 10 ~ 95% RH non-condensing			
	TEMP. COEFFICIENT	± 0.03%/°C (0 ~ 50°C)			
	VIBRATION	20 ~ 500Hz, 10G 12min./1cycle, period for 72min. each along X, Y, Z axes			
SAFETY & EMC (Note.6)	SAFETY STANDARDS	UL62368-1, TUV EN62368-1, EAC TP TC 004 approved; design refer to EN61558-1, EN60335-1(by request)			
	WITHSTAND VOLTAGE	I/P-O/P:3KVAC I/P-FG:2KVAC O/P-FG:1.25KVAC			
	ISOLATION RESISTANCE	I/P-O/P, I/P-FG, O/P-FG:100M Ohms/500VDC/25°C / 70%RH			
	EMC EMISSION	Parameter	Standard	Test Level / Note	
		Conducted	EN55032 (CISPR32)	Class B	
		Radiated	EN55032 (CISPR32)	Class B	
		Harmonic Current	EN61000-3-2	Class A	
	Voltage Flicker	EN61000-3-3	-----		
	EMC IMMUNITY	EN55024 , EN61000-6-2			
		Parameter	Standard	Test Level / Note	
		ESD	EN61000-4-2	Level 3, 8KV air ; Level 2, 4KV contact	
		Radiated	EN61000-4-3	Level 3	
		EFT / Burst	EN61000-4-4	Level 3	
		Surge	EN61000-6-2	2KV/Line-Line 4KV/Line-Earth	
Conducted		EN61000-4-6	Level 3		
Magnetic Field		EN61000-4-8	Level 4		
Voltage Dips and Interruptions	EN61000-4-11	>95% dip 0.5 periods, 30% dip 25 periods, >95% interruptions 250 periods			
OTHERS	MTBF	197.9K hrs min. Telcordia SR-332 (Bellcore) ; 52.32K hrs min. MIL-HDBK-217F (25°C)			
	DIMENSION	310*144*48.5mm (L*W*H)			
	PACKING	4Kg;4pcs/17Kg/1.04CUFT			
NOTE	<ol style="list-style-type: none"> All parameters NOT specially mentioned are measured at 230VAC input, rated load and 25°C of ambient temperature. Ripple & noise are measured at 20MHz of bandwidth by using a 12" twisted pair-wire terminated with a 0.1uf & 47uf parallel capacitor. Tolerance :includes set up tolerance, line regulation and load regulation. Derating may be needed under low input voltages. Please check the derating curve for more details. PV/PC functions when users do not use SVR. The power supply is considered a component which will be installed into a final equipment. All the EMC tests are been executed by mounting the unit on a 720mm*360mm metal plate with 1mm of thickness. The final equipment must be re-confirmed that it still meets EMC directives. For guidance on how to perform these EMC tests, please refer to "EMI testing of component power supplies." (as available on http://www.meanwell.com) The ambient temperature derating of 3.5°C/1000m with fanless models and of 5°C/1000m with fan models for operating altitude higher than 2000m(6500ft). 				



SPECIFICATION FOR CHARGER

MODEL		HEP-1000-24	HEP-1000-48	HEP-1000-100	
OUTPUT	BOOST CHARGE VOLTAGE V_{boost}	28.8V	57.6V	115.2V	
	FLOAT CHARGE VOLTAGE V_{float}	27.6V	55.2V	110.4V	
	RECOMMENDED BATTERY CAPACITY(AMP HOURS)(Note 2)	120 ~ 350AH	60 ~ 175AH	30 ~ 85AH	
	BATTERY TYPE	Open & Sealed Lead Acid			
	OUTPUT CURRENT	35A	17.5A	8.7A	
INPUT	VOLTAGE RANGE <small>Note 3</small>	90 ~ 305VAC 250 ~ 431VDC			
	FREQUENCY RANGE	47 ~ 63Hz			
	POWER FACTOR (Typ.)	PF>0.99/115VAC, PF>0.95/230VAC, PF>0.93/277VAC at full load			
	EFFICIENCY (Typ.)	95%	96%	96%	
	AC CURRENT (Typ.)	10.1A / 115VAC	5.3A / 230VAC	4.5A / 277VAC	
	INRUSH CURRENT(Typ.)	Cold start 40A at 230VAC			
	LEAKAGE CURRENT	<0.75mA / 240VAC			
PROTECTION	SHORT CIRCUIT	Constant current limiting, unit will shutdown after 5 sec, re-power on to recover.			
	OVER VOLTAGE	30 ~ 35V	60 ~ 70V	125 ~ 145V	
	OVER TEMPERATURE	Protection type :Shut down O/P voltage,recovers automatically after temperature goes down			
FUNCTION	REMOTE ON/OFF CONTROL	Power ON : Short circuit Power OFF : Open circuit			
	AUXILIARY POWER	12V @ 0.5A tolerance $\pm 10\%$, ripple=150mVp-p			
	DC-OK SIGNAL	The TTL signal out, PSU turn on = 4.4 ~ 5.5V ; PSU turn off = -0.5 ~ 0.5V. Please refer to the Function Manual.			
ENVIRONMENT	WORKING TEMP.	-40 ~ +70°C (Refer to "Derating Curve")			
	WORKING HUMIDITY	20 ~ 95% RH non-condensing			
	STORAGE TEMP., HUMIDITY	-40 ~ +80°C, 10 ~ 95% RH non-condensing			
	TEMP. COEFFICIENT	$\pm 0.03\%/^{\circ}\text{C}$ (0 ~ 50°C)			
	VIBRATION	20 ~ 500Hz, 10G 12min./1cycle, period for 72min. each along X, Y, Z axes			
SAFETY & EMC (Note.4)	SAFETY STANDARDS	UL62368-1,TUV EN62368-1, EAC TP TC 004 approved; design refer to EN61558-1, EN60335-1(by request)			
	WITHSTAND VOLTAGE	I/P-O/P:3KVAC I/P-FG:2KVAC O/P-FG:1.25KVAC			
	ISOLATION RESISTANCE	I/P-O/P, I/P-FG,O/P-FG:100M Ohms/500VDC/25°C / 70%RH			
	EMC EMISSION	Parameter	Standard	Test Level / Note	
		Conducted	EN55032 (CISPR32)	Class B	
		Radiated	EN55032 (CISPR32)	Class A	
		Harmonic Current	EN61000-3-2	Class A	
		Voltage Flicker	EN61000-3-3	-----	
	EMC IMMUNITY	EN55024 , EN61000-6-2			
		Parameter	Standard	Test Level / Note	
		ESD	EN61000-4-2	Level 3, 8KV air ; Level 2, 4KV contact	
		Radiated	EN61000-4-3	Level 3	
		EFT / Burst	EN61000-4-4	Level 3	
		Surge	EN61000-6-2	2KV/Line-Line 4KV/Line-Earth	
		Conducted	EN61000-4-6	Level 3	
Magnetic Field		EN61000-4-8	Level 4		
Voltage Dips and Interruptions		EN61000-4-11	>95% dip 0.5 periods, 30% dip 25 periods, >95% interruptions 250 periods		
OTHERS	MTBF	197.9K hrs min. Telcordia SR-332 (Bellcore) ; 52.32K hrs min. MIL-HDBK-217F (25°C)			
	DIMENSION	310*144*48.5mm (L*W*H)			
	PACKING	4Kg;4pcs/17Kg/1.04CUFT			
NOTE	<p>1. All parameters NOT specially mentioned are measured at 230VAC input, rated load and 25°C of ambient temperature.</p> <p>2. This is Mean Well's suggested range. Please consult your battery manufacturer for their suggestions about maximum charging current limitation.</p> <p>3. Derating may be needed under low input voltages. Please check the derating curve for more details.</p> <p>4. The power supply is considered a component which will be installed into a final equipment. All the EMC tests are been executed by mounting the unit on a 720mm*360mm metal plate with 1mm of thickness. The final equipment must be re-confirmed that it still meets EMC directives. For guidance on how to perform these EMC tests, please refer to "EMI testing of component power supplies." (as available on http://www.meanwell.com)</p> <p>5. The ambient temperature derating of 3.5°C/1000m with fanless models and of 5°C/1000m with fan models for operating altitude higher than 2000m(6500ft).</p>				

■ BLOCK DIAGRAM

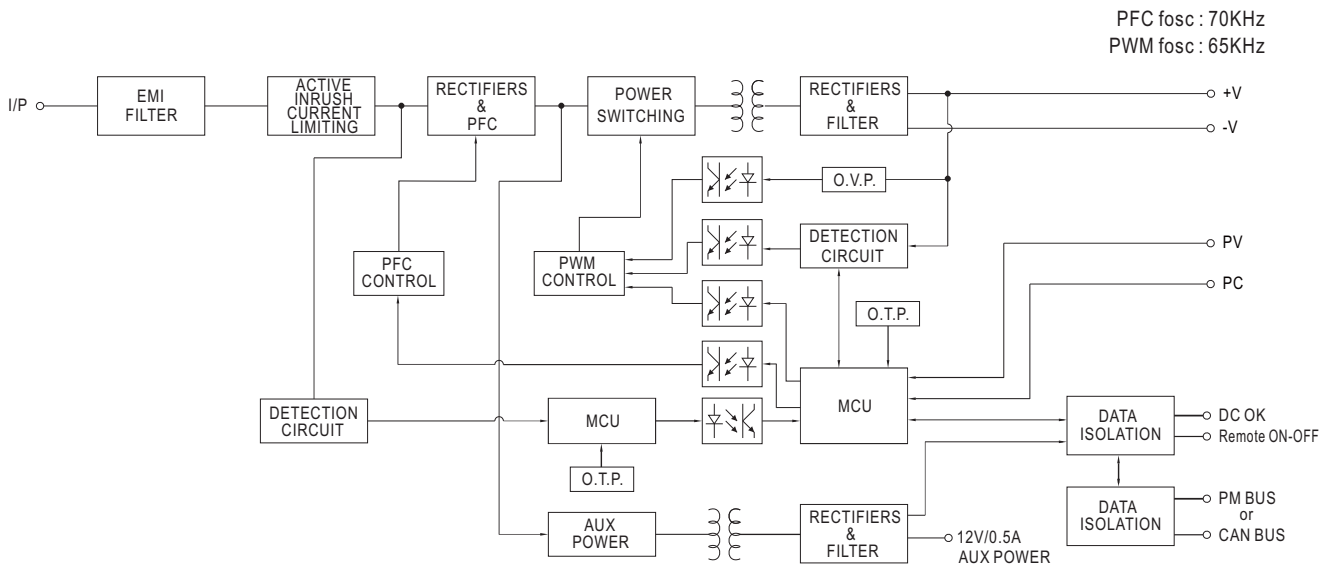

■ DERATING CURVE

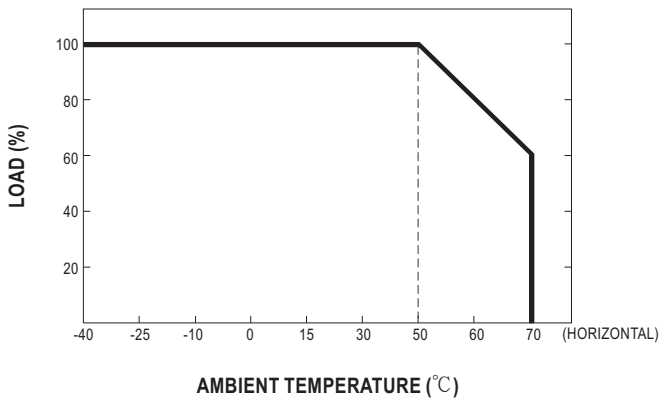

■ STATIC CHARACTERISTICS

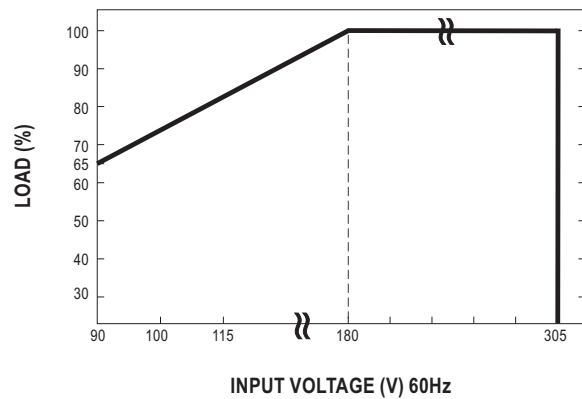

※ For 100V model charging mode, output current is 20% rated min. when operating temperature at -40°C, and can reach 100% above -30°C.

FUNCTION MANUAL

1. Charging Curve

- ※ By default, the HEP-1000 operates in power supply mode, and it can be configured to charger mode by PMBus, CANBus, or SBP-001.
- ※ By factory default, this charger performs the default curve which can be programmed via PMBus and CANBus.
- ※ To accommodate the parameters of the charging curve, SBP-001, the smart battery charging programmer designed by MEAN WELL, and a personal computer are needed. Please contact MEAN WELL for details.

※ Default 2 stage charging curve

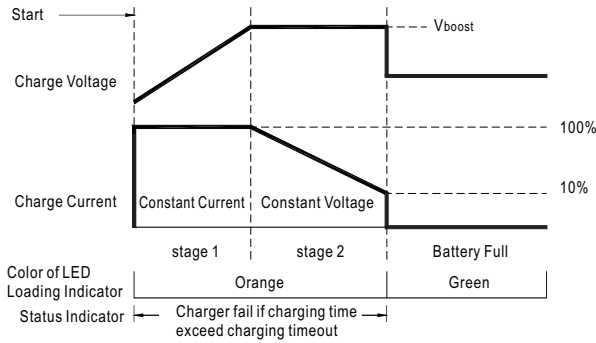

State	HEP-1000-24	HEP-1000-48	HEP-1000-100
Constant Current	35A	17.5A	8.7A
V _{boost}	28.8V	57.6V	115.2V

◎ Suitable for lead-acid batteries (flooded, Gel and AGM) and Li-ion batteries (lithium iron and lithium manganese).

※ Default 3 stage charging curve

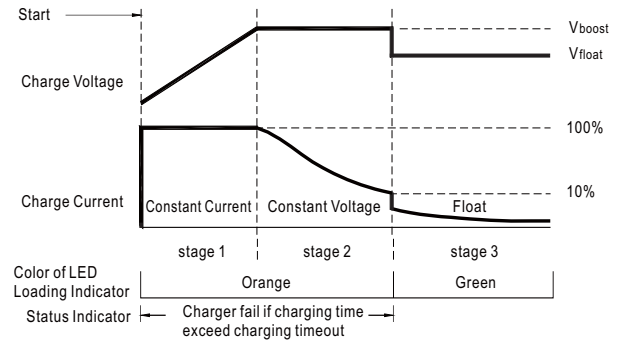

State	HEP-1000-24	HEP-1000-48	HEP-1000-100
Constant Current	35A	17.5A	8.7A
V _{boost}	28.8V	57.6V	115.2V
V _{float}	27.6V	55.2V	110.4V

◎ Suitable for lead-acid batteries (flooded, Gel and AGM) and Li-ion batteries (lithium iron and lithium manganese).

2. Front Panel LED Indicators & Corresponding Signal at Function Pins

LED	Description
● Green	Float (stage 3)
● Orange	Charging (stage 1 or stage 2)
● Red	Abnormal status (OTP, OLP, Charging timeout.)
● Red (Flashing)	The LED will flash with the red light when the internal temperature reaches 95°C; under this condition, the unit still operates normally without entering OTP. (In the meantime, an alarm signal will be sent out through the PMBus interface.)

3. Output Voltage Programming (or, PV / remote voltage programming / remote adjust / margin programming / dynamic voltage trim)

- ※ In addition to the adjustment via the built-in potentiometer, the output voltage can be trimmed by applying EXTERNAL VOLTAGE.

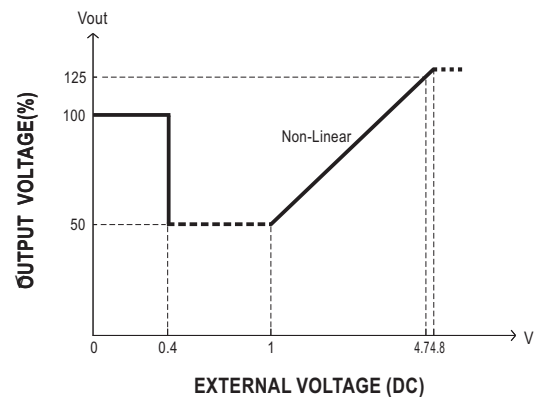
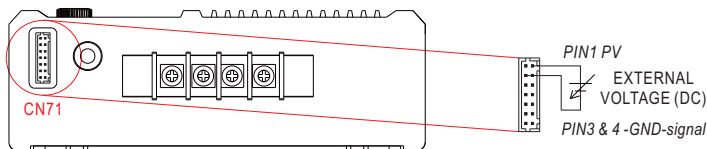

4. Output Current Programming (or, PC / remote current programming / dynamic current trim)

※ The output current can be trimmed to 20~100% of the rated current by applying EXTERNAL VOLTAGE.

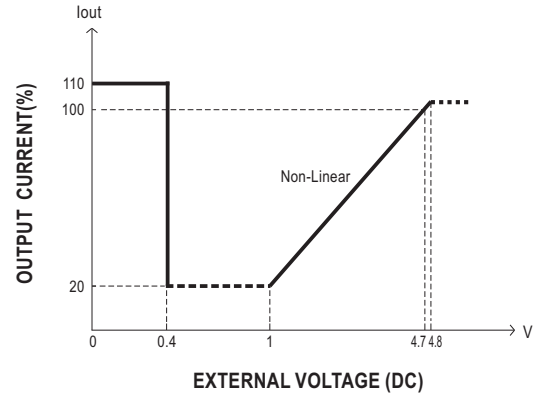
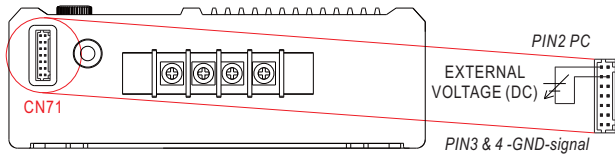

5. Remote ON-OFF Control

The power supply can be turned ON/OFF individually or along with other units in parallel by using the "Remote ON-OFF" function.

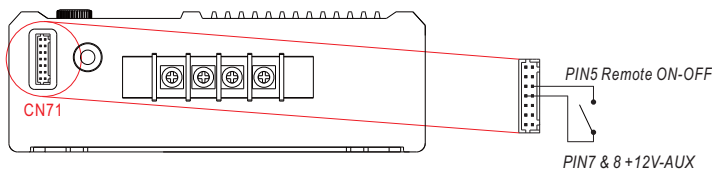

Remote ON-OFF	Power Supply Status
Short circuit	ON
Open circuit	OFF

6. DC-OK Signal

DC-OK signal is a TTL level signal. The maximum source current is 10mA and the maximum external voltage is 5.5V.

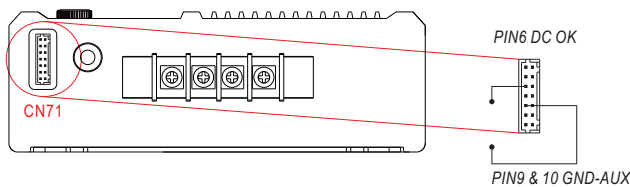

DC-OK signal	Power Supply Status
"High" >4.4~5.5V	ON
"Low" <-0.5~0.5V	OFF

7. Temperature Compensation

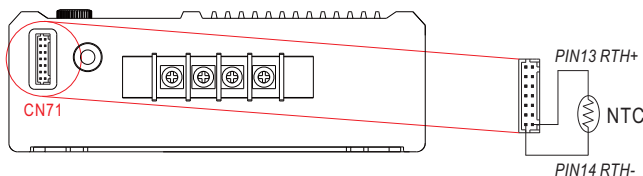

- ◎ To exploit the temperature compensation function, please attach the temperature sensor, NTC, which is enclosed with the charger, to the battery or the battery's vicinity.
- ◎ The charger is able to work normally without the NTC.

8. PMBus Communication Interface

HEP-1000 supports PMBus Rev. 1.1 with maximum 100KHz bus speed, allowing information reading, status monitoring, output trimming, etc. For details, please refer to the User's Manual.

MECHANICAL SPECIFICATION

Case No.228F

Unit:mm

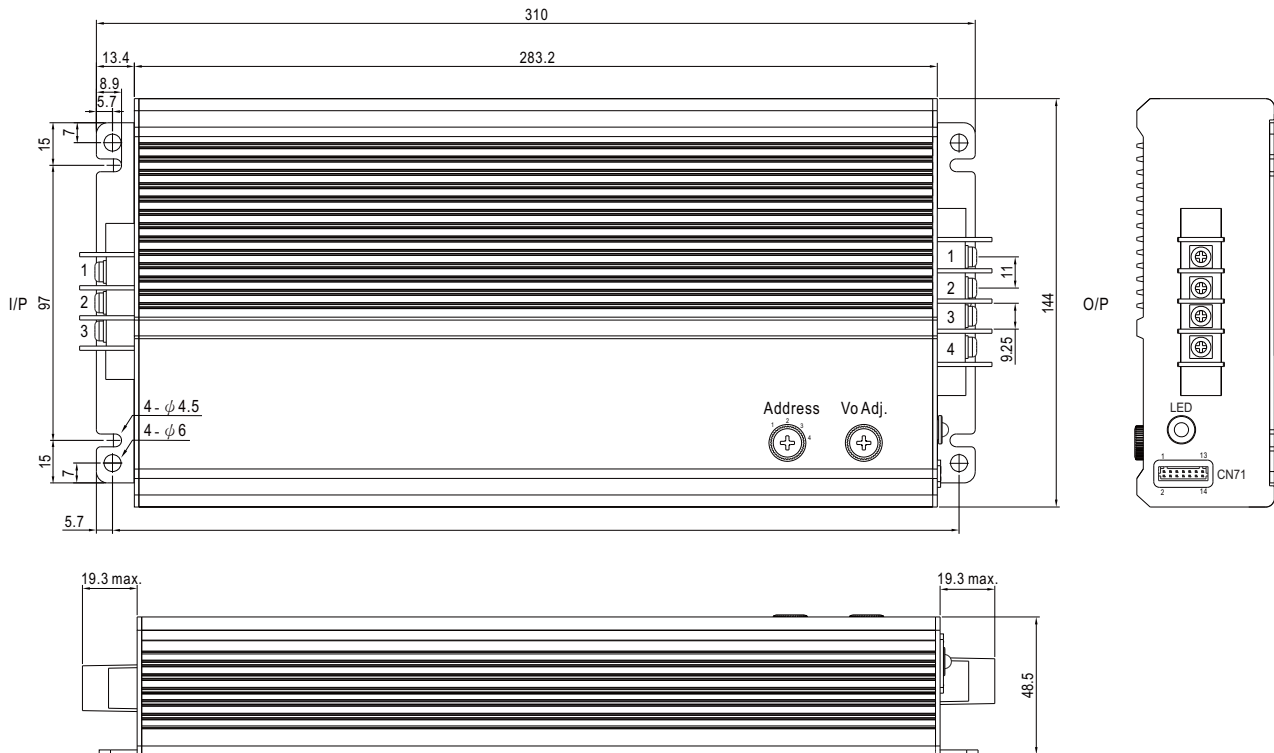

- ※ Output voltage current level can be adjusted through internal potentiometer.(Vo Adj.)
(Can access by removing the rubber stopper on the case.)
- ※ PMBus interface address selection.(Address)

AC Input Terminal Pin No. Assignment

Pin No.	Assignment
1	FG (⊖)
2	AC/L
3	AC/N

DC Output Terminal Pin No. Assignment

Pin No.	Assignment
1,2	-V
3,4	+V

※Control Pin No. Assignment(CN71) : JST S14B-PHDKS-B or equivalent

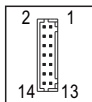

Mating Housing	JST PHDR-14VS or equivalent
Terminal	JST SPHD-001T-P0.5 or equivalent

Pin No.	Function	Description
1	PV	Connection for output voltage programming.(Note 1)
2	PC	Connection for constant current level programming.(Note.1)
3,4	GND (Signal)	Negative output voltage signal.
5	Remote ON-OFF	The unit can turn the output ON/OFF by dry contact between Remote ON/OFF and +12-AUX.(Note.2) Short (10.8 ~ 13.2V) : Power ON ; Open(0 ~ 0.5V) : Power OFF ; The maximum input voltage is 13.2V
6	DC-OK	Low (-0.5 ~ 0.5V) : When $V_{out} \leq 77\% \pm 6\%$ at power mode. $V_{out} \leq 66\% \pm 6\%$ at charger mode. High (4.4 ~ 5.5V) : When $V_{out} \geq 80\% \pm 6\%$ at power mode. $V_{out} \geq 67\% \pm 6\%$ at charger mode. The maximum sourcing current is 10mA and only for output.(Note.2)
7,8	+12V-AUX	Auxiliary voltage output, 10.8~13.2V, referenced to GND-AUX (pin9 & 10). The maximum load current is 0.5A. This output is not controlled by "Remote ON-OFF".
9,10	GND-AUX	Auxiliary voltage output GND. The signal return is isolated from the output terminals (+V & -V).
11	SDA	For PMBus model: Serial Data used in the PMBus interface. (Note.2)
	CANH	For CANBus model: Data line used in CANBus interface. (Note.2)
12	SCL	For PMBus model: Serial Clock used in the PMBus interface. (Note.2)
	CANL	For CANBus model: Data line used in CANBus interface. (Note.2)
13	RTH+	Temperature sensor(NTC, 5KOhm) comes along with the charger can be connected to the unit to allow temperature compensation of the charging voltage.
14	RTH-	

Note1: Non-isolated signal, referenced to [GND(signal)].

Note2: Isolated signal, referenced to GND-AUX.

INSTALLATION MANUAL

Please refer to : <http://www.meanwell.com/manual.html>