



**ODP Series Triple Output  
Linear Programmable DC Power Supply  
User Manual**

■ ODP3033

■ ODP3063

■ ODP6033

[www.owon.com.cn](http://www.owon.com.cn)



7007020100047

## **July 2019 edition V1.2.0**

Copyright © LILLIPUT Company. All rights reserved.

The LILLIPUT's products are under the protection of the patent rights, including ones which have already obtained the patent rights and those which are applied for. The information in this manual will replace all materials published.

The information in this manual was correct at the time of printing. However, LILLIPUT will continue to improve products and reserves the rights to change specification at any time without notice.

**owon**<sup>®</sup> is the registered trademark of the LILLIPUT Company.

### **Fujian LILLIPUT Optoelectronics Technology Co., Ltd.**

No. 19, Heming Road

Lantian Industrial Zone, Zhangzhou 363005 P.R. China

**Tel:** +86-596-2130430

**Fax:** +86-596-2109272

**Web:** [www.owon.com.cn](http://www.owon.com.cn)

**E-mail:** [info@owon.com.cn](mailto:info@owon.com.cn)

# General Warranty

OWON warrants that the product will be free from defects in materials and workmanship for a period of 2 years (1 year for accessories) from the date of purchase of the product by the original purchaser from the OWON Company. This warranty only applies to the original purchaser and is not transferable to a third party.

If the product proves defective during the warranty period, OWON will either repair the defective product without charge for parts and labour, or will provide a replacement in exchange for the defective product. Parts, modules and replacement products used by OWON for warranty work may be new or reconditioned like new. All replaced parts, modules and products become the property of OWON.

To obtain service under this warranty, the customer must notify OWON of the defect before the expiration of the warranty period. Customer shall be responsible for packaging and shipping the defective product to OWON's designated service centre, a copy of the customer's proof of purchase is also required.

This warranty shall not apply to any defect, failure or damage caused by improper use or improper or inadequate maintenance and care. OWON shall not be obligated to furnish service under this warranty a) to repair damage resulting from attempts by personnel other than OWON representatives to install, repair or service the product; b) to repair damage resulting from improper use or connection to incompatible equipment; c) to repair any damage or malfunction caused by the use of non-OWON supplies; or d) to service a product that has been modified or integrated with other products when the effect of such modification or integration increases the time or difficulty of servicing the product.

Please contact the nearest OWON's Sales and Service Offices for services.

For better after-sales service, please visit [www.owon.com.cn](http://www.owon.com.cn) and register the purchased product online.

**Excepting the after-sales services provided in this summary or the applicable warranty statements, OWON will not offer any guarantee for maintenance definitely declared or hinted, including but not limited to the implied guarantee for marketability and special-purpose acceptability. OWON should not take any responsibilities for any indirect, special or consequent damages.**

# Table of Contents

<b>1. General Safety Requirements</b>	<b>1</b>
<b>2. Safety Terms and Symbols</b>	<b>2</b>
<b>3. Quick Start</b>	<b>3</b>
<b>3.1 Front/Rear Panel and User Interface</b>	<b>3</b>
3.1.1 Front Panel	3
3.1.2 Rear Panel	5
3.1.3 User Interface	5
Mode Icons	6
Status Icons	7
<b>3.2 General Inspection</b>	<b>7</b>
<b>3.3 Power-On Check</b>	<b>7</b>
<b>3.4 Output Inspection</b>	<b>8</b>
3.4.1 Voltage Output Inspection	8
3.4.2 Current Output Inspection	8
<b>4. Front Panel Operation</b>	<b>9</b>
<b>4.1 Turn On/Off the Channel Output</b>	<b>9</b>
<b>4.2 Set the Output Voltage/Current</b>	<b>9</b>
4.2.1 Set the Output Voltage	9
4.2.2 Set the Output Current	9
<b>4.3 Over Voltage/Current Protection</b>	<b>10</b>
4.3.1 Set O.V.P	10
4.3.2 Set O.C.P	10
<b>4.4 Programmable Output</b>	<b>11</b>
4.4.1 Data View	11
4.4.2 Output Set	11
4.4.3 Data process	12
4.4.4 Turn On/Off Programmable Output	13
<b>4.5 Save Settings/Auto Record</b>	<b>13</b>
4.5.1 Save Settings	13
4.5.2 Auto Record	14
4.5.3 View Record	14
<b>4.6 Output mode</b>	<b>15</b>
<b>4.7 Utility Settings</b>	<b>18</b>
4.7.1 Language	18
4.7.2 Brightness	18
4.7.3 Beeper	18
4.7.4 Clock	18

<b>4.8 System Info .....</b>	<b>18</b>
4.8.1 View System Information .....	18
4.8.2 Set as Default.....	18
4.8.3 Update.....	19
<b>4.9 Port Settings .....</b>	<b>20</b>
4.9.1 Serial port .....	20
4.9.2 LAN Set .....	21
4.9.3 LCD Test.....	21
4.9.4 Key Test .....	21
<b>5. Troubleshooting .....</b>	<b>22</b>
<b>6. Technical Specifications .....</b>	<b>23</b>
<b>7. Appendix.....</b>	<b>25</b>
<b>7.1 Appendix A: Packaging .....</b>	<b>25</b>
<b>7.2 Appendix B: General Care and Cleaning.....</b>	<b>25</b>

# 1. General Safety Requirements

**Before use, please read the following safety precautions to avoid any possible bodily injury and to prevent this product or any other connected products from damage. To avoid any contingent danger, ensure this product is only used within the ranges specified.**

Only a qualified person should perform internal maintenance.

## **To avoid Fire or Personal Injury:**

- **Use Proper Power Cord.** Use only the power cord supplied with the product and certified to use in your country.
- **Product Grounded.** This instrument is grounded through the power cord grounding conductor. To avoid electric shock, the grounding conductor must be grounded. The product must be grounded properly before any connection with its input or output terminals.
- **Check all Terminal Ratings.** To avoid fire or shock hazard, check all ratings and markings on this product. Refer to the user manual for more information about ratings before connecting to the instrument.
- **Do not operate without covers.** Do not operate the instrument with covers or panels removed.
- **Use the Proper Fuse.** Use only the specified type and rating fuse for this instrument.
- **Avoid exposed circuit.** Be careful when working on exposed circuitry to avoid risk of electric shock or other injury.
- **Do not operate if any damage.** If you suspect damage to the instrument, have it inspected by qualified service personnel before further use.
- **Use your instrument in a well-ventilated area.** Please keep well ventilated and inspect the intake and fan regularly.
- **Do not operate in damp conditions.** To avoid short circuiting to the interior of the device or electric shock, please do not operate in a humid environment.
- **Do not operate in an explosive atmosphere.** To avoid damages to the device or personal injuries, it is important to operate the device away from an explosive atmosphere.
- **Keep product surfaces clean and dry.** To avoid the influence of dust or moisture in air, please keep the surface of device clean and dry.

## 2. Safety Terms and Symbols

### Safety Terms

**Terms in this manual** (The following terms may appear in this manual):



**Warning:** Warning indicates conditions or practices that could result in injury or loss of life.



**Caution:** Caution indicates the conditions or practices that could result in damage to this product or other property.

**Terms on the product.** The following terms may appear on this product:

**Danger:** Indicates an immediate hazard or injury possibility.

**Warning:** Indicates a possible hazard or injury.

**Caution:** Indicates potential damage to the instrument or other property.

### Safety Symbols

**Symbols on the product.** The following symbols may appear on the product:



Hazardous Voltage



Refer to Manual



Protective Earth Terminal



Chassis Ground



Public Ground

## 3. Quick Start

### 3.1 Front/Rear Panel and User Interface

#### 3.1.1 Front Panel

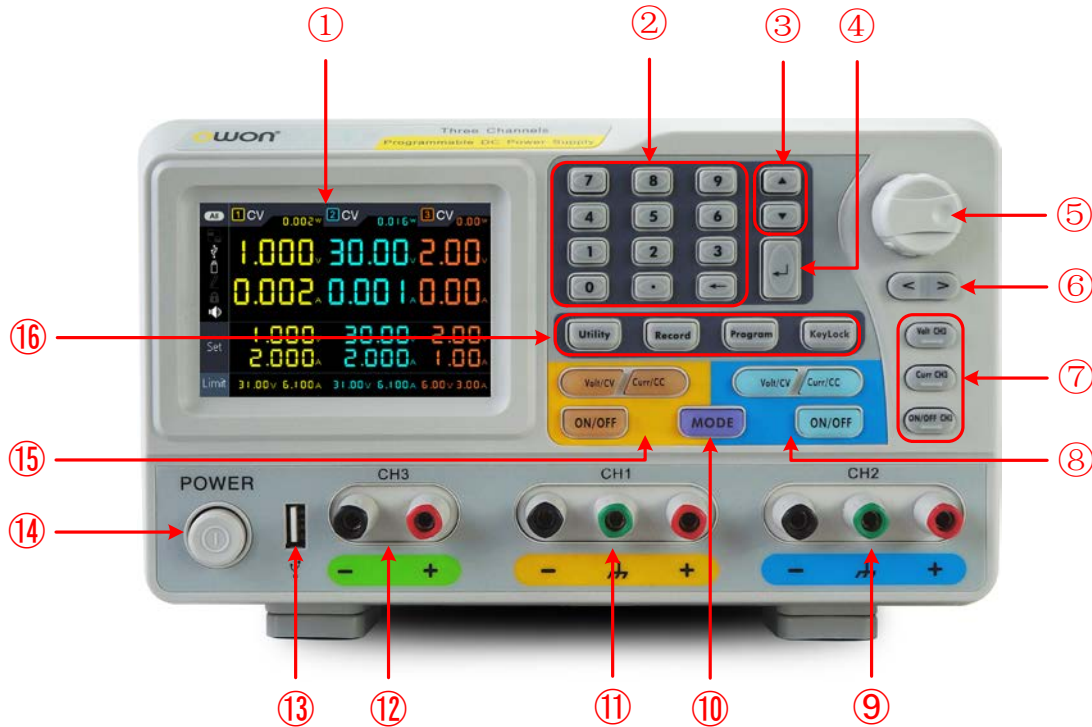

Figure 3-1 Front panel overview

①	<b>LCD</b>	User interface display
②	<b>Numeric keys area</b>	Parameter input, includes the numeric keys, decimal point and backspace key.
③	<b>Up and down direction key</b>	Select sub menu
④	<b>Enter key</b>	Enter menu or confirm the parameter entered
⑤	<b>Knob</b>	Select menu or change the value, pressing it has the same effect as pressing the enter key
⑥	<b>Left and right direction key</b>	Set sub menu or move the cursor
⑦	<b>CH3 control area</b>	<b>Volt CH3</b> key: Set the output voltage of CH3 <b>Curr CH3</b> key: Set the output current of CH3 <b>ON/OFF CH3</b> key: Enable/disable the output of CH3



### 3.Quick Start

---

⑧	<b>CH2 control area</b>	<b>Blue</b> <b>Volt/CV</b> key: Set the output voltage of CH2 <b>Blue</b> <b>Curr/CC</b> key: Set the output current of CH2 <b>Blue</b> <b>ON/OFF</b> key: Enable/disable the output of CH2
⑨	<b>CH2 output terminals</b>	Channel 2 output connectors
⑩	<b>MODE key</b>	Switch between All Channel mode (CH1 & CH2 & CH3) and Dual Channel Mode (CH1 & CH2).
⑪	<b>CH1 output terminals</b>	Channel 1 output connectors
⑫	<b>CH3 output terminals</b>	Channel 3 output connectors
⑬	<b>USB Host port</b>	Connect as a "host device" with an external USB device, such as connect a USB disk to the instrument.
⑭	<b>Power button</b>	Turn on/off the instrument
⑮	<b>CH1 control area</b>	<b>Orange</b> <b>Volt/CV</b> key: Set the output voltage of CH1 <b>Orange</b> <b>Curr/CC</b> key: Set the output current of CH1 <b>Orange</b> <b>ON/OFF</b> key: Enable/disable the output of CH1
⑯	<b>Function keys</b>	<b>Utility</b> key: Menu of output mode, utility, info, port settings. <b>Record</b> key: Save settings, auto record, and view recording. <b>Program</b> key: Programmable output. <b>KeyLock</b> key: Press and hold this key for 5 seconds to lock the panel keys. Unlock method: Press and hold the key for more than 5 seconds, and release.

---

#### Instructions for panel key indicator

**ON/OFF** key: The indicator will be lit after you turn on the channel.

**Volt/CV** key: The indicator will be lit when the channel is in Constant Voltage output mode.

**Curr/CC** key: The indicator will be lit when the channel is in Constant Current output mode.

### 3.1.2 Rear Panel

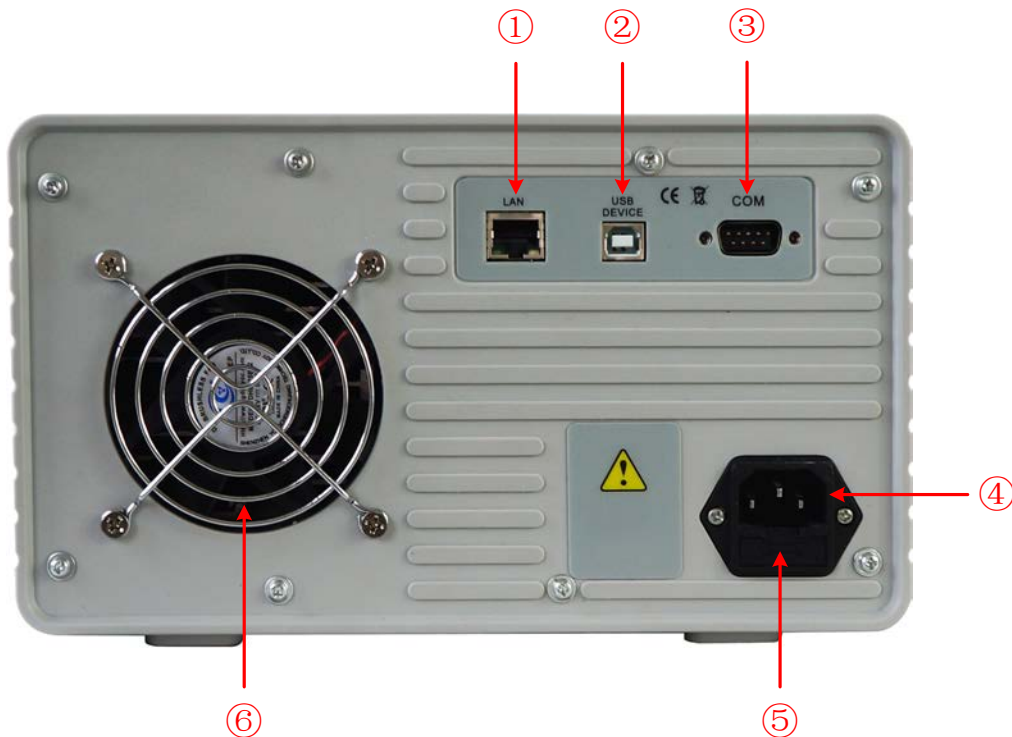

Figure 3-2 Rear panel overview

① <b>Local Area Network (LAN) Connector</b>	The power supply can be connected to the network for remote control via this connector.
② <b>USB Device Connector</b>	Connect as a "slave device" with an external USB device, such as connect the instrument to a PC.
③ <b>COM Connector</b>	Connect the power supply with external equipment as serial port.
④ <b>Power socket</b>	AC input connector
⑤ <b>Fuse</b>	Line fuse
⑥ <b>Fan</b>	Fan inlet

### 3.1.3 User Interface

When the output mode is in independent output, or channel tracking mode, there are two display modes: All channel mode (CH1 & CH2 & CH3), Dual channel mode (CH1 & CH2). Press the **Mode** panel key to switch between the modes.

- **All Channel Mode**

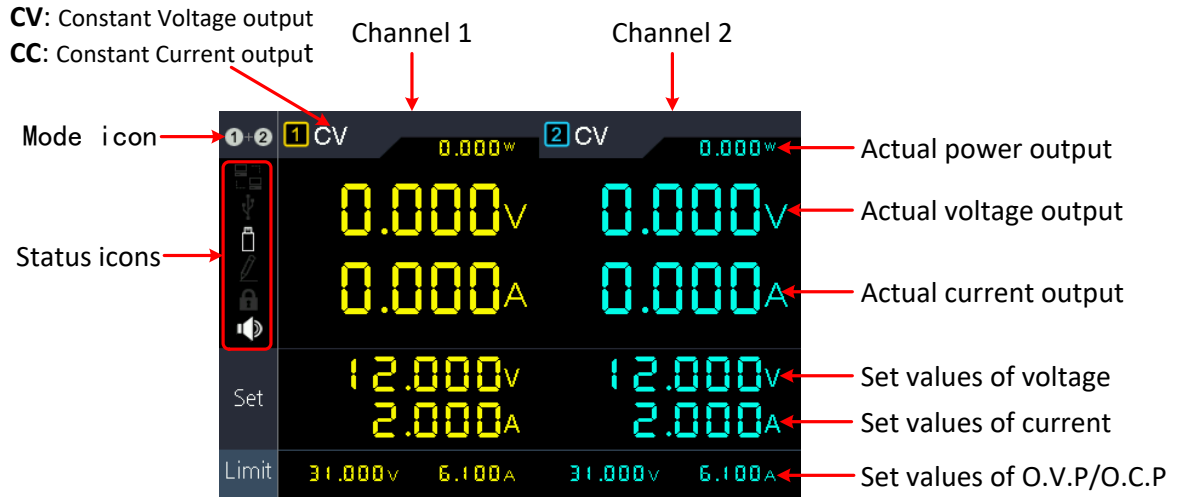

Figure 3-3 User interface in All channel mode

● **Dual Channel Mode**

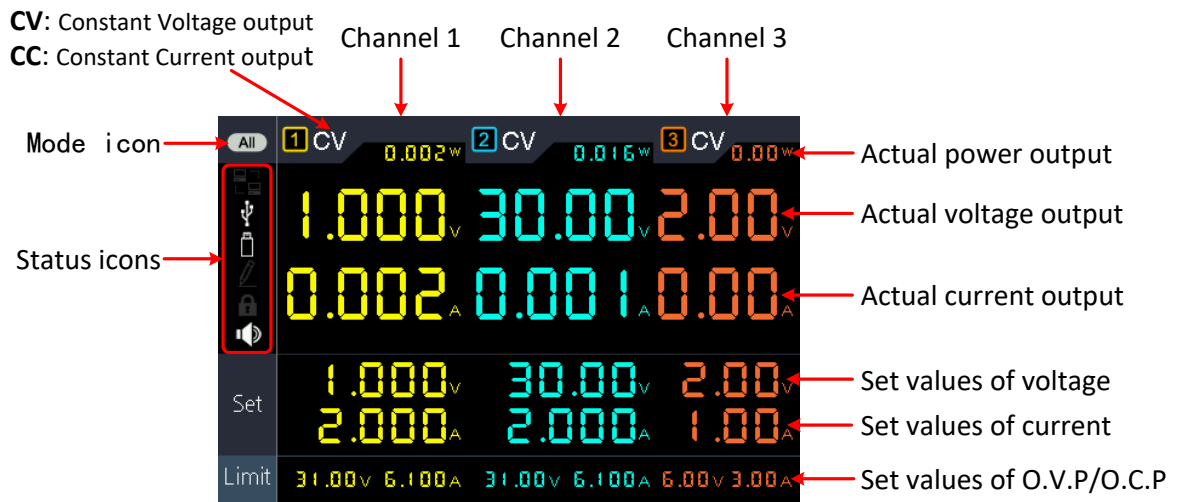







Figure 3-4 User interface in Dual channel mode

**Mode Icons**

Icons	Instruction
	All mode, display CH1, CH2 and CH3
	Dual channel mode, display CH1 & CH2
	The output mode is parallel tracking
	The output mode is series tracking

## Status Icons

Icons	Instruction
	Connected to the network via LAN connector
	Connected as a slave device with PC
	A USB device is connected
	Recording the current output
	The panel keys are locked
	The beeper is turned on

## 3.2 General Inspection

When you receive your new power supply, it is recommended that you check the instrument following these steps:

### 1. Check for transportation damage.

If it is found that the packaging carton or the foamed plastic protection cushion has suffered serious damage, do not throw it away until the complete device and its accessories have been electrically and mechanically checked.

### 2. Check the Accessories

The supplied accessories are described in the "Appendix A: " of this Manual. Please ensure that all the listed accessories are present and undamaged, if any problems are found please contact your distributor or OWON's local office.

### 3. Check the Complete Instrument

If there is any physical damage, operational fault, or performance issue please contact your distributor or OWON's local office. If there is any transportation damage to the instrument please ensure you keep the original packaging. Ideally you should always keep the original packaging if the instrument must be returned for repair.

## 3.3 Power-On Check

- (1) Connect the instrument to the AC supply using the supplied power cord.



### Warning:

To avoid electric shock, the instrument must be grounded properly.

- (2) Push the **power button** on the front panel, the keys will light and the screen will show the boot screen.

## 3.4 Output Inspection

Output inspection is to ensure that the instrument can achieve its rated outputs and properly respond to operation from the front panel. For the procedures below, it is suggested that you read "*Turn On/Off the Channel Output*" on page 9 and "*Set the Output Voltage/Current*" on page 9.

### 3.4.1 Voltage Output Inspection

The following steps verify basic voltage functions without load:

- (1) When the instrument is under no load, select a channel and ensure the output current setting for this channel is not at zero.
- (2) Turn on the channel output, then ensure the channel is in Constant Voltage output mode.
- (3) Set some different voltage values on this channel; check if the actual voltage value displayed is close to the set voltage value, and also that the actual current value displayed is nearly to zero.
- (4) Check that if the output voltage can be adjusted from zero to the maximum rating.

### 3.4.2 Current Output Inspection

The following steps check basic current functions with a short across the power supply's output:

- (1) Connect a short across (+) and (-) output terminals with an insulated test lead on this channel. Use a wire size sufficient to handle the maximum current.
- (2) Set the output voltage to the maximum rating on this channel.
- (3) Turn on the channel output. Ensure the channel you used is in Constant Current output mode.
- (4) Set some different current values on this channel; check if the actual current value displayed is close to the set current value, and to check if the actual voltage value displayed is nearly zero.
- (5) Check that if the output current can be adjusted from zero to the maximum rating.
- (6) Turn off the channel output and remove the short circuit from the output terminals.

## 4. Front Panel Operation

### 4.1 Turn On/Off the Channel Output

Press the **orange ON/OFF** key to turn on/off the Channel 1 output.

Press the **blue ON/OFF** key to turn on/off the Channel 2 output.

Press the **ON/OFF CH3** key to turn on/off the Channel 3 output.

### 4.2 Set the Output Voltage/Current

#### 4.2.1 Set the Output Voltage

- **Set the output voltage of CH1**

Press the **orange Volt/CV** key, the first digit of the CH1 set voltage is flashing, indicating the value is editable. There are two methods to change the value.

**Modify:** Turn the **knob** to change the value. Press the **< / >** key to move the cursor. Press the **knob** or the **↵** key to confirm.

**Input:** Use the **numeric keys** to input, the input box of **Channel 1** output voltage will pop up. Enter a desired value. Press the **↵** key to confirm.

- **Set the output voltage of CH2**

Press the **blue Volt/CV** key to enter edit mode. You can set the value in the same way as CH1 above.

- **Set the output voltage of CH3**

Press the **Volt CH3** key to enter edit mode. You can set the value in the same way as CH1 above.

#### 4.2.2 Set the Output Current

- **Set the output current of CH1**

Press the **orange Curr/CC** key, the first digit of the CH1 set current is flashing, indicating the value is editable. There are two methods to change the value.

**Modify:** Turn the **knob** to change the value. Press the **< / >** key to move the cursor. Press the **knob** or the **↵** key to confirm.

**Input:** Use the **numeric keys** to input, the input box of **Channel 1** output current will pop up. Enter a desired value. Press the **↵** key to confirm.

- **Set the output current of CH2**

Press the **blue Curr/CC** key to enter edit mode. You can set the value in the same way as CH1 above.

- **Set the output current of CH3**

Press the **Curr CH3** key to enter edit mode. You can set the value in the same way as CH1 above.

---

**Note:** If the input value is out of the rated range, the box prompts "ERROR"; you need to input another value within the rated range.

---

### 4.3 Over Voltage/Current Protection

When the Over Voltage Protection (O.V.P) or Over Current Protection (O.C.P) is enabled, once the output voltage/current reaches the set value of O.V.P/O.C.P, the instrument will cut off the output, a warning will show on the screen.

**Note:**

When the instrument disables the output due to protection, after you make some adjustments, the channel must be restarted to output normally.

---

This function can keep the power output from exceeding the load rating to protect the load.

#### 4.3.1 Set O.V.P

- **Set the O.V.P of CH1**

Press the **orange Volt/CV** key, the first digit of the CH1 set voltage is flashing. Press the **▼** key, the first digit of the CH1 O.V.P is flashing, indicating the value is editable. There are two methods to change the value.

**Modify:** Turn the **knob** to change the value. Press the **< / >** key to move the cursor. Press the **knob** or the **↵** key to confirm.

**Input:** Use the **numeric keys** to input, the input box of **Channel 1** limit voltage will pop up. Enter a desired value. Press the **↵** key to confirm.

- **Set the O.V.P of CH2**

Press the **blue Volt/CV** key, then press the **▼** key to enter edit mode. You can set the value in the same way as CH1 above.

- **Set the O.V.P of CH3**

Press the **Volt CH3** key, then press the **▼** key to enter edit mode. You can set the value in the same way as CH1 above.

#### 4.3.2 Set O.C.P

- **Set the O.C.P of CH1**

Press the **orange Curr/CC** key, the first digit of the CH1 set current is flashing. Press the **▼** key, the first digit of the CH1 O.C.P is flashing, indicating the value is editable. There are two methods to change the value.

**Modify:** Turn the **knob** to change the value. Press the **◀ / ▶** key to move the cursor. Press the **knob** or the **↵** key to confirm.

**Input:** Use the **numeric keys** to input, the input box of **Channel 1** limit current will pop up. Enter a desired value. Press the **↵** key to confirm.

- **Set the O.C.P of CH2**

Press the **blue Curr/CC** key, then press the **▼** key to enter edit mode. You can set the value in the same way as CH1 above.

- **Set the O.C.P of CH3**

Press the **Curr CH3** key, then press the **▼** key to enter edit mode. You can set the value in the same way as CH1 above.

## 4.4 Programmable Output

The programmable output function can preset up to 100 groups of timing parameters. When you turn on the programmable output, the instrument will output the pre-specified voltage, current in pre-specified time.

### 4.4.1 Data View

Press the **Program** key. The **Data view** menu is selected.

(1) The **Memory** sub menu is selected. Press the **◀ / ▶** key to select **Internal** or **External**.

(2) Press the **▼** key to select **Import** submenu. Press the **↵** key to import data.

(3) Press the **▼** key to select **Export** submenu. Press the **↵** key to export data.

**Note:** When the memory is set as External, the programmable data file will be export to U disk, the directory is **ODPXXXX\Program** (ODPXXXX is the model).

(4) Press the **▼** key to select **Clear Data** submenu. Press the **↵** key to clear data.







### 4.4.2 Output Set

Press the **Program** key, turn the **knob** to select [**Output Set**].

(1) The **Cycle Mode** sub menu is selected. Press the **◀ / ▶** key to select **Oder** or **Loop**.

(2) Press the **▼** key to select **Start Point** submenu. Use the **numeric keys** to input (1 to 100), press the **↵** key to confirm.









- (3) Press the  key to select **Stop Point** submenu. Use the **numeric keys** to input (1 to 100), press the  key to confirm.
- (4) Press the  key to select **Start** submenu. Press the  /  key to select the channel (CH1, CH2 or ALL), press the  key to enter the data processing interface and output the selected channel.

### 4.4.3 Data process

You can set the programmable parameters of CH1 and CH2, including voltage, current and output time. This function allows up to 100 parameter groups of each channel.

Press the **Program** key, turn the **knob** to select [**Data process**].

#### Edit:

- (1) The **Edit** sub menu is selected. The operation instruction shows on the screen. Press the  key to enter the data processing interface.
- (2) In the data processing interface, Press the  /  key to move the cursor left and right. Press the  /  key to move the cursor up and down. Turn the **knob** to move the cursor between CH1 and CH2. Use the After selecting the parameter, use the numeric keys to enter a desired value, press the  key to confirm.

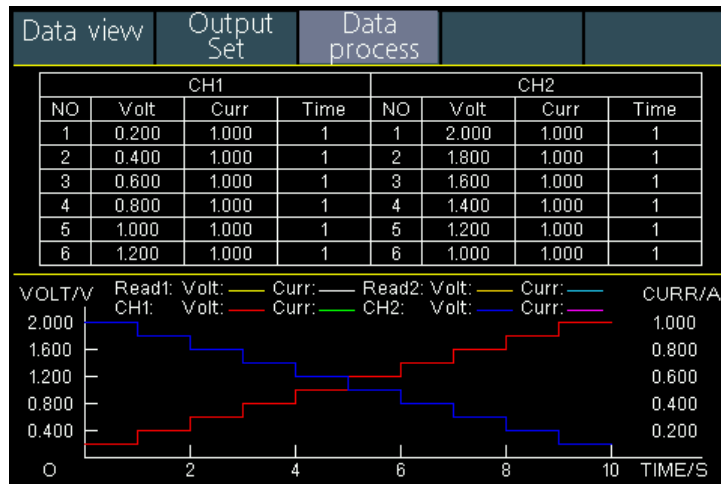









Figure 4-1 Data processing Interface

- (3) Press  to back to sub menu selection.

**Graph process** is used to configure the graphical display in the **Data processing interface**.

- (1) Press the  key to select **Graph process** submenu. Press the  key to enter the editing interface.
- (2) In the Graph processing interface, Press the  /  key to move the cursor left and right. Press the  /  key to move the cursor up and down. Press the  key to check or uncheck the item. If the item is checked, the corresponding line will be

displayed in the chart in the data processing interface.

(3) Press  to back to sub menu selection.

#### 4.4.4 Turn On/Off Programmable Output

**In the data processing interface:**

- **Independent Mode**





Press **orange**  key to turn on/off the programmable output of **Channel 1**.

Press **blue**  key to turn on/off the programmable output of **Channel 2**.

- **Parallel/Series Mode**

Press **orange**  key to turn on/off the programmable output.

**In the data processing interface:**

Press the  key to select **Start** submenu. Press the  /  key to select the channel (CH1, CH2 or ALL), press the  key to enter the data processing interface and output the selected channel.

---

**Note:**

In the process of programmable output, closing the channel output will reset the timer; turning on the channel again will restart the programmable output and the timer.



---





## 4.5 Save Settings/Auto Record

### 4.5.1 Save Settings









You can store, recall and delete current setting parameters. The storage memory could be set as internal or external (USB flash device). Up to 100 groups of settings can be saved.

Press the  key. The **Save Settings** menu is selected.

(1) The **Memory** sub menu is selected. Press the  /  key to select **Internal** or **External**.

(2) Press the  key to select **Save** submenu. Press the  /  key to select the channel (CH1, CH2 or CH3), press the  key to save the setting of the selected channel.

**Note:** When the memory is set as External, the setting will be saved to U disk as a CSV file, the directory is **ODPXXXX\Record\_Option** (ODPXXXX is the model).

(3) Press the  key to select **Delete** submenu. Press the  key, a red box will show in the table, indicating the selected item. Press the  /  key to select. Press the  /  key to turn the page. Press the  key to delete. Press  to back to

sub menu selection.

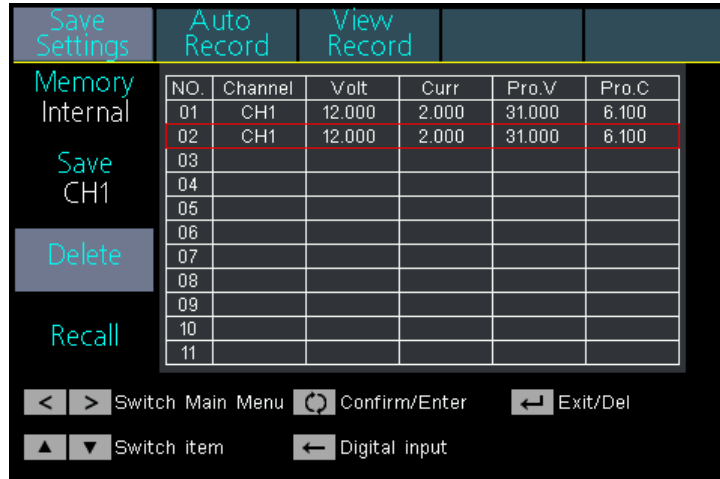

- (4) Press the key to select **Recall** submenu. Press the key, a red box will show in the table, indicating the selected item. Press the / key to select. Press the / key to turn the page. Press the key to recall. Press to back to sub menu selection.

#### 4.5.2 Auto Record

Press the **Record** key, turn the knob to select [**Auto Record**].

- (1) The **Memory** sub menu is selected. Press the / key to select **Internal** or **External**.
- (2) Press the key to select **Interval** submenu. Use the **numeric keys** to set the record interval, press the key to confirm.
- (3) Press the key to select **Points** submenu. Use the **numeric keys** to set the points, press the key to confirm.
- (4) Press the key to select **Record Status** submenu. Press the / key to select the channel (CH1, CH2 or CH3), press the key to start recording the output of the selected channel. Press the key again to stop recording. During recording, the icon will be lighted on the status bar.











**Note:** When the memory is set as External, the record file will be saved to U disk as a CSV file, the directory is **ODPXXXX\Record\_Auto** (ODPXXXX is the model).



#### 4.5.3 View Record

Press the **Record** key, turn the knob to select [**View Record**].

- (1) Press the key to select **Memory** submenu. Press the / key to select **Internal** or **External**.
- (2) When the Memory is set as **Internal**, press the key to select **Read** submenu. Press

## 4.Front Panel Operation

the  /  key to select the channel (CH1, CH2 or CH3), press the  key to read the recording file of the selected channel. After reading successfully, if the display mode is set as Table, a red box will show in the table, indicating you can press the  /  key to turn the page. Press  to back to sub menu selection. When the Memory is set as **External**, press the  key to select **Export** submenu. Press the  /  key to select the channel (CH1, CH2 or CH3), press the  key to export the recording file of the selected channel onto the U disk. The directory is **ODPXXXX\Record\_Auto** (ODPXXXX is the model).

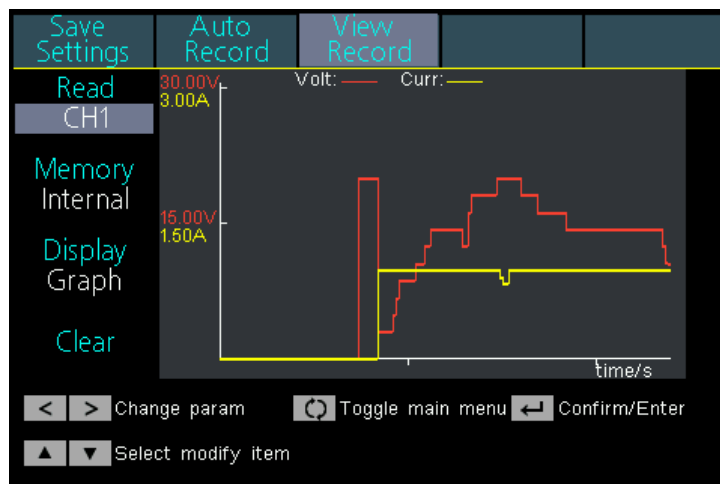

- (3) Press the  key to select **Display** submenu. Press the  /  key to select **Graph** or **Table**.



**Graph display mode**

NO.	Volt	Curr	Power
61	8.708	1.998	17.395
62	8.708	1.998	17.395
63	10.605	1.998	21.184
64	10.605	1.998	21.185
65	10.605	1.998	21.185
66	12.510	1.998	24.990
67	12.512	1.998	24.993
68	14.406	1.998	28.776
69	14.406	1.998	28.776
70	14.405	1.998	28.774

**Table display mode**

- (4) Press the  key to select **Clear** submenu. Press the  key to clear the recording file.

## 4.6 Output mode

Output mode can simplify the parameter inputting of CH1 and CH2. Output mode setting

is only for CH1 and CH2, without affecting CH3. There are four output modes:

- **Independent Output**

The parameter of each channel can be set independently.

- **Parallel track**

When CH1 and CH2 are connected in parallel, you can select this mode to simplify the parameter inputting. You just need to set the parameters of the combined channel. The voltage rating is same as the single channel; the current rating is the sum of CH1 and CH2 current rating.

Press the **orange ON/OFF** key to turn on/off the combined channel.

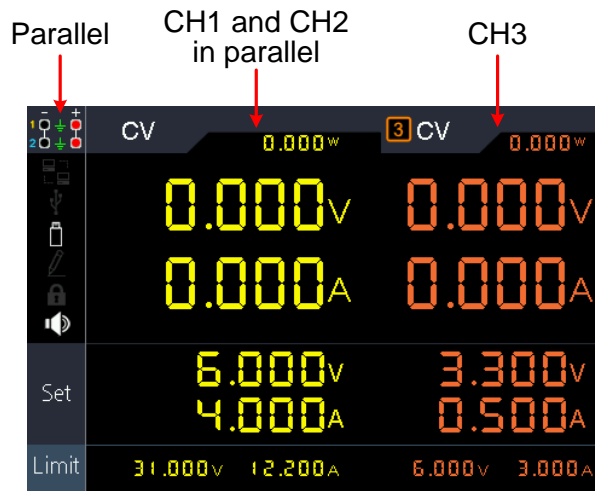

The connection method of the parallel connection of CH1 and CH2 is as shown in the figure below.

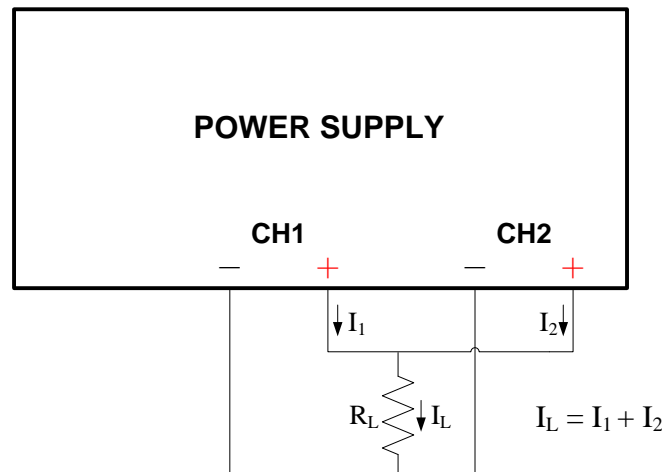

- **Series track**

When CH1 and CH2 are connected in series, you can select this mode to simplify the parameter inputting. You just need to set the parameters of the combined channel. The voltage rating is the sum of CH1 and CH2 voltage rating; the current rating is same as the single channel.

Press the **orange ON/OFF** key to turn on/off the combined channel.

## 4. Front Panel Operation

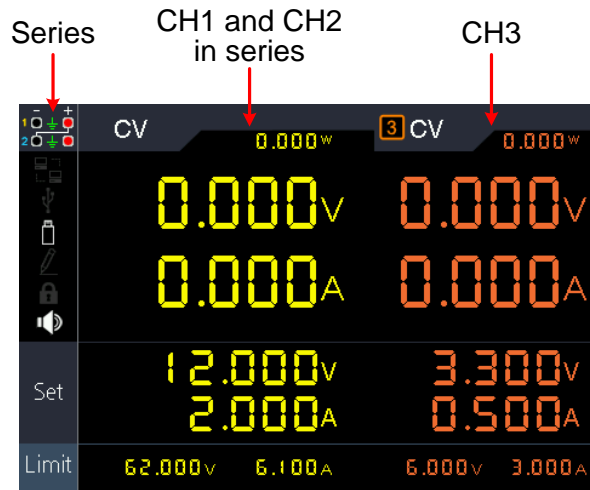

The connection method of the series connection of CH1 and CH2 is as shown in the figure below.

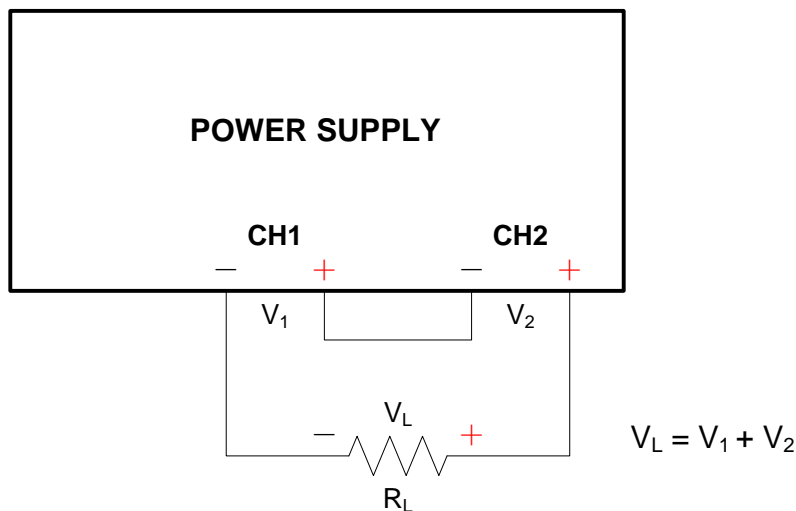

### ● Channel track

In independent output mode, set the output parameters of CH1 and CH2, and then enter the channel track mode, if the parameters of any one channel are changed, the other channel will change proportionally.

For example, in independent output mode, set the CH1 voltage to 2V, current to 1A; set the CH2 voltage to 4V, current to 2A. After entering channel track mode, if CH1 voltage is set to 6V, CH2 voltage will be adjusted to 12V proportionally. If CH1 current is set to 2A, CH2 current will be adjusted to 4A proportionally.



Note: If the setting value is out of the rated range, it will be set to the maximum.

### To set the output mode:



- (1) Press the **Utility** key. The **Output mode** menu is selected.
- (2) Press the **▲ / ▼** key to select the output mode. Press the **↵** key to check and enter the selected mode.

## 4.7 Utility Settings





### 4.7.1 Language

Press the **Utility** key, turn the knob to select [Utility]. The **Language** sub menu is selected. Press the  /  key to choose the desired language. The supported languages include: Chinese, English and so on.





### 4.7.2 Brightness

Press the **Utility** key, turn the knob to select [Utility]. Press the  key to select **Brightness** submenu. Press the  /  key to adjust the screen brightness. The brightness can be set to 0%, 25%, 50%, 75%, 100%.

### 4.7.3 Beeper

Press the **Utility** key, turn the knob to select [Utility]. Press the  key to select **Beeper** submenu. Press the  /  key to turn on/off the beeper. When the beeper is on, the icon  will be lighted on the status bar. When the system prompts the instrument will make a buzzing sound, e.g. cutting off the output due to O.V.P/O.C.P.

### 4.7.4 Clock



Press the **Utility** key, turn the knob to select [Utility]. Press the  key to select **Clock** submenu. Use the **numeric keys** to input, press the  key to confirm. Press the  /  key to move the cursor.

## 4.8 System Info

### 4.8.1 View System Information

Press the **Utility** key, turn the knob to select [Info]. The **Info** sub menu is selected. You can view the version, serial number, and checksum.

### 4.8.2 Set as Default

Press the **Utility** key, turn the knob to select [Info]. Press the  key to select **Default** submenu. Press the  key to use the factory defaults, see table below.

	Output	VOLT	CURR
Output settings	CH1	12.00V	2.000A
	CH2		
	CH3		
	Parallel	12.000V	6.000A
	Series	36.000V	2.000A

#### 4.Front Panel Operation

Limit settings	Output	VOLT	CURR
	CH1	MAXOUT+1V	MAXOUT+0.1A
	CH2		
	CH3		
	Parallel	MAXOUT+1V	2*(MAXOUT+0.1A)
Series	2*(MAXOUT+1V)	MAXOUT+0.1A	

Utility	Output mode		Independent mode	
	Brightness		50%	
	Beeper		On	
	Port	Serial	Baud	115200
			Data Bits	8
			Odd-Even	None
			Stop Bits	1
		LAN Set	IP	192.168.001.099
			Subnet Mask	255.255.255.000
			Gateway	192.168.001.001
Port	3000			

Record	Save Settings	Memory	Internal
		Save	CH1
	Auto Record	Memory	Internal
		Interval	1
		Points	1000
		Record Status	CH1
	View Record	Read	CH1
		Memory	Internal
		Display	Graph

Program	Data view	Memory	Internal
	Output Set	Cycle Mode	Order
		Start Point	1
		Stop Point	100
	Data process	Graph process	SET&READ(CH1:VOLT,CURR;CH2:VOLT,CURR)

#### 4.8.3 Update

Use the front-panel USB port to update your instrument firmware using a USB memory device.

**USB memory device requirements:** This instrument only supports a USB memory device





with a FAT32 file system. If the USB memory device doesn't work properly, format it into the FAT32 format and try again; or try another USB memory device.



**Caution:** Updating your instrument firmware is a sensitive operation, to prevent damage to the instrument, do not power off the instrument or remove the USB memory device during the update process.

---

### To update your instrument firmware, do the following:

- (1) Press the **Utility** key, turn the knob to select [**Info**]. The **Info** sub menu is selected. You can view the model and firmware version.
- (2) From a PC, visit [www.owon.com.cn](http://www.owon.com.cn) and check if the website offers a newer firmware version. Download the firmware file. The file name must be ODPFW.upp. Copy the firmware file onto the root directory of your USB memory device.
- (3) Insert the USB memory device into the front-panel USB port on your instrument. If the status icon  appears on the left of the screen, the USB memory device is installed successfully.
- (4) Press the **Utility** key, turn the knob to select [**Info**]. Press the  key to select **Update** submenu. Press the  key.
- (5) The instrument displays a message telling you not to remove the USB device or power off the instrument until the update process is complete. The progress bar of the screen indicates the update process is in progress.

**Note:** A firmware update usually takes approximately a minute. Do not remove the USB memory device during the update process. If you accidentally removed the USB memory device during the update process, do not power off the instrument. Repeat the installation process from step 3.

- (6) Wait until the instrument displays "Firmware upgrade success.", and then it will reboot automatically.



**Note:** If the operation complete message is not displayed, do not power off the instrument. Repeat the installation process from step 2 using a different type of USB memory device.

- (7) Remove the USB memory device from the front-panel USB connector.
- (8) Press the **Utility** key, turn the knob to select [**Info**]. The **Info** sub menu is selected, view the firmware version. Confirm that the firmware has been updated.











## 4.9 Port Settings

### 4.9.1 Serial port



Press the **Utility** key, turn the knob to select [**Port Set**]. The **Serial** sub menu is selected.







- (1) Press the  key to enter sub menu. The **Baud** is selected. Press the  /  key to select the desired baud rate from 1200, 2400, 4800, 9600, 19200, 38400,

57600 or 115200. The default is 115200. Make sure that the baud rate matches that of the computer.

- (2) Press the  key to select **Data Bits**. Press the  /  key to select 6, 7, or 8.
- (3) Press the  key to select **Odd-Even**. Press the  /  key to select None, Odd, or Even.
- (4) Press the  key to select **Stop Bits**. Press the  /  key to 1 or 2.  
Press  to back to sub menu selection.



### 4.9.2 LAN Set



Press the  key, turn the knob to select **[Port Set]**. Press the  key to select **Lan Set** submenu.

- (1) Press the  key to enter edit mode. Set the IP address, subnet mask, gateway, and port. Use the **numeric keys** to input, press the  key to confirm. Press the  /  key to move the cursor left and right. Press the  /  key to move the cursor up and down. Press  to back to sub menu selection.
- (2) Restart the instrument for the parameter changes to take effect.

### 4.9.3 LCD Test



The instrument has a screen self test function, which can test the LCD screen.



Press the  key, turn the knob to select **[Port Set]**. Press the  key to select **Lcd Test** submenu.

- (1) Press the  key to enter the screen test interface.
- (2) Press the  key to switch the color between red, green, and blue. Observe if the screen has severe color shift, spot, scuffing, or other defect.
- (3) Press the  key to exit the test.

### 4.9.4 Key Test

The instrument provides the key self testing, which can test the keys on the front panel.

Press the  key, turn the knob to select **[Port Set]**. Press the  key to select **Key Test** submenu.

- (1) Press the  key to enter the key test interface.
- (2) Each shape on the test interface represents a front panel key. Press any front panel key, the corresponding shape on the test interface will turn green.
- (3) Press the  key to exit the test.

## 5. Troubleshooting

### 1. The instrument is powered on but no Display.

- Check if the power is connected properly.
- Check if the fuse which is below the AC Power socket is used appropriately and in good condition (the cover can be pried open with a straight screwdriver).
- Restart the instrument after the steps above.
- If the problem still exists, please contact **OWON** for our service.

### 2. The output is abnormal:

- Check if the output voltage is set to 0V. If so, set it to other value.
- Check if the output current is set to 0A. If so, set it to other value.
- When in programmable output status, check if there is any voltage/current value is set to 0. If so, set it to other value.
- If the problem still exists, please contact **OWON** for our service.

### 3. Cannot identify the USB device correctly:

- Check if the USB device is in good condition.
- Check if the used USB device is a flash device, note a hard disk cannot be supported.
- Restart the instrument and insert your USB flash device again.
- If the problem still exists, please contact **OWON** for our service.

## 6. Technical Specifications

The specifications below are based on the instrument having run for at least 30 minutes continuously under the specified operating temperature.

Specifications		CH1	CH2	CH3
Output Ratings (0°C-40°C)	ODP3033	Voltage	0-30V	0-6V
		Over Voltage Protection	31V	7V
		Current	0-3A	0-3A
		Over Current Protection	3.1A	3.1A
		Power	90W	18W
	ODP3063	Voltage	0-30V	0-6V
		Over Voltage Protection	31V	7V
		Current	0-6A	0-3A
		Over Current Protection	6.1A	3.1A
		Power	180W	18W
	ODP6033	Voltage	0-60V	0-6V
		Over Voltage Protection	61V	7V
		Current	0-3A	0-3A
		Over Current Protection	3.1A	3.1A
		Power	180W	18W
Load Regulation		Voltage	$\leq 0.01\% + 3\text{mV}$	
		Current	$\leq 0.01\% + 3\text{mA}$	
Line Regulation		Voltage	$\leq 0.01\% + 3\text{mV}$	
		Current	$\leq 0.01\% + 3\text{mA}$	
Settings Resolution		Voltage	1mV	
		Current	1mA	
Read Back Resolution		Voltage	1mV	
		Current	1mA	
Settings Accuracy (Within 12 months) (25°C±5°C)		Voltage	$\leq 0.03\% + 10\text{mV}$	
		Current	$\leq 0.1\% + 8\text{mA}$	$\leq 0.1\% + 5\text{mA}$
Read Back Accuracy (25°C±5°C)		Voltage	$\leq 0.03\% + 10\text{mV}$	
		Current	$\leq 0.1\% + 8\text{mA}$	$\leq 0.1\% + 5\text{mA}$
Noise and Ripple (20Hz-20MHz)		Voltage (Vp-p)	$\leq 4\text{mVp-p}$	$\leq 3\text{mVp-p}$
		Voltage (rms)	$\leq 1\text{mVrms}$	
		Current (rms)	$\leq 5\text{mA rms}$	$\leq 4\text{mA rms}$
Output Temperature		Voltage	$\leq 0.03\% + 10\text{mV}$	

## 6. Technical Specifications

<b>Coefficient (0°C-40°C)</b>	Current	≤0.1%+5mA
<b>Read Back Temperature Coefficient</b>	Voltage	≤0.03%+10mV
	Current	≤0.1%+5mA
<b>Parallel Settings Accuracy</b>	Voltage	≤0.02%+5mV
	Current	≤0.1%+30mA
<b>Programmable output</b>	Storage	1M points
	Groups saved in internal memory	100 groups
	Time setting	Second
<b>Data Record Function</b>	10k groups of data (voltage, current, power)	
<b>Ports</b>	USB Host, USB Device, RS232, LAN, supports USB TMC protocol	

### Display

Display Type	4 inch colored LCD (Liquid Crystal Display)
Display Resolution	480 (Horizontal) × 320 (Vertical) Pixels
Display Colors	65536 colors, TFT screen

### Power

Supply	110 VAC ± 10% or 220 VAC ± 10%; AC input 50/60Hz		
Fuse	ODP3033	110 V	250 V, F5A
		220 V	250 V, F3A
	ODP3063	110 V	250 V, F10A
		220 V	250 V, F5A

### Environment

Temperature	Working temperature: 0°C ~ 40°C Storage temperature: -20°C ~ 60°C
Relative Humidity	≤ 90%
Height	Operating: 3,000 m Non-operating: 15,000 m
Cooling Method	Fan cooling

### Mechanical Specifications

Dimension	250mm × 158mm × 358mm (W*H*D)	
Weight	ODP3033	About 9.8 kg
	ODP3063	About 12.0 kg
	ODP6033	

### Interval Period of Adjustment:

One year is recommended for the calibration interval period.

## 7. Appendix

### 7.1 Appendix A: Packaging

(The accessories subject to final delivery.)

#### Standard Accessories:



**Power Cord**



**CD Rom**



**User Manual**



**USB Cable**



**Fuse**

#### Options:



**Banana plug to  
crocodile clip  
test leads**

### 7.2 Appendix B: General Care and Cleaning

#### General Care

Do not store or leave the instrument where the liquid crystal display could be exposed to direct sunlight for long periods of time.

**Caution:** To avoid any damage to the instrument, do not exposed it to any sprays, liquids, or solvents.

#### Cleaning

Inspect the instrument as often as operating conditions require.

To clean the instrument exterior, perform the following steps:

1. Wipe the dust from the instrument surface with a soft cloth. Take care not to scratch the transparent LCD protection screen when cleaning.
2. Disconnect power before cleaning your instrument. Clean the instrument with a damp soft cloth (not dripping with water). It is recommended to clean with soft detergent or fresh water. To avoid damage to the instrument, do not use any corrosive chemical cleaning agents.



**Warning:** Before re applying power, ensure that the instrument is completely dry, avoiding any electric shock or electrical short circuit resulting from moisture.

---