

Distributed by:



www.Jameco.com ♦ 1-800-831-4242

The content and copyrights of the attached material are the property of its owner.

AVAILABLE THROUGH DISTRIBUTION



BOURNS®

Jameco Part Number 240602

Features

- 3/8" Square/ Multiturn / Cermet / Industrial / Sealed
- Five popular terminal styles
- Standoffs
- Patent #4427966 drive mechanism

3299 - 3/8" Square Trimming Potentiometer

Electrical Characteristics

Standard Resistance Range10 to 2 megohms (see standard resistance table)
 Resistance Tolerance±10 % std. (tighter tolerance available)
 Absolute Minimum Resistance1 % or 2 ohms max. (whichever is greater)
 Contact Resistance Variation1.0 % or 3 ohms max. (whichever is greater)
 Adjustability
 Voltage±0.01 %
 Resistance±0.05 %
 ResolutionInfinite
 Insulation Resistance500 vdc. 1,000 megohms min.
 Dielectric Strength
 Sea Level900 vac
 70,000 Feet350 vac
 Effective Travel25 turns nom.

Environmental Characteristics

Power Rating (300 volts max.)
 70 °C0.5 watt
 125 °C0 watt
 Temperature Range-55 °C to +125 °C
 Temperature Coefficient±100 ppm/°C
 Seal Test85 °C Fluorinert*
 HumidityMIL-STD-202 Method 103 96 hours (2 % ΔTR, 10 Megohms IR)
 Vibration20 G (1 % ΔTR; 1 % ΔVR)
 Shock100 G (1 % ΔTR; 1 % ΔVR)
 Load Life1,000 hours 0.5 watt @ 70 °C (3 % ΔTR; 3 % or 3 ohms, whichever is greater, CRV)
 Rotational Life200 cycles (4 % ΔTR; 3 % or 3 ohms, whichever is greater, CRV)

Physical Characteristics

Torque3.0 oz-in. max.
 Mechanical StopsWiper idles
 TerminalsSolderable pins
 Weight0.035 oz.
 MarkingManufacturer's trademark, resistance code, wiring diagram, date code, manufacturer's model number and style
 Wiper50 % ±10 %
 FlammabilityU.L. 94V-0
 Standard Packaging50 pcs. per tube
 Adjustment ToolH-90

3299P

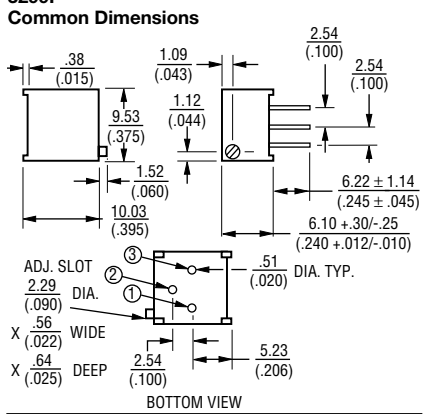

3299W

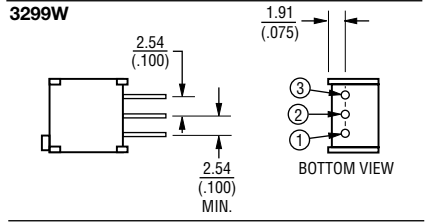

3299X

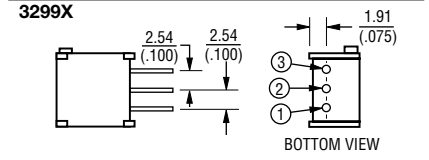

3299Y

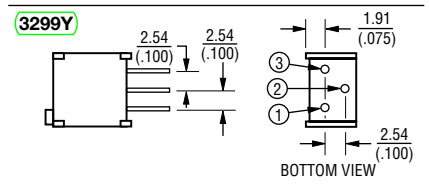

3299Z

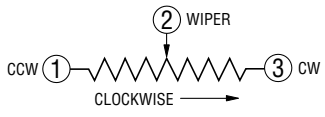
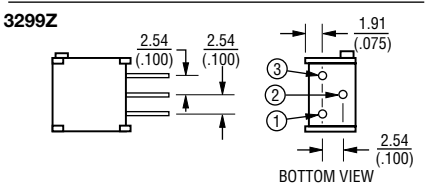

Standard Resistance Table

Resistance (Ohms)	Resistance Code
10	100
20	200
50	500
100	101
200	201
500	501
1,000	102
2,000	202
5,000	502
10,000	103
20,000	203
25,000	253
50,000	503
100,000	104
200,000	204
250,000	254
500,000	504
1,000,000	105
2,000,000	205

Popular distribution resistance values listed in boldface. Special resistances available.

How To Order

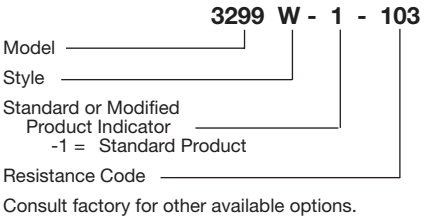

TOLERANCES: ± 0.25 (.010) EXCEPT WHERE NOTED
 DIMENSIONS ARE: $\frac{\text{MM}}{\text{(INCHES)}}$

**"FLUORINERT" IS A REGISTERED TRADEMARK OF 3M CO.

Specifications are subject to change without notice. Customers should verify actual device performance in their specific applications.