

Distributed by:

JAMECO[®]
ELECTRONICS

www.Jameco.com ♦ 1-800-831-4242

The content and copyrights of the attached
material are the property of its owner.

Jameco Part Number 24329FSC

LM556/NE556

Dual Timer

Features

- Replaces Two LM555/NE555 Timers
- Operates in Both Astable And Monostable Modes
- High Output Current
- TTL Compatible
- Timing From Microsecond To Hours
- Adjustable Duty Cycle
- Temperature Stability Of 0.005% Per °C

Applications

- Precision Timing
- Pulse Shaping
- Pulse Width Modulation
- Frequency Division
- Traffic Light Control
- Sequential Timing
- Pulse Generator
- Time Delay Generator
- Touch Tone Encoder
- Tone Burst Generator

Description

The LM556/NE556 series dual monolithic timing circuits are a highly stable controller capable of producing accurate time delays or oscillation. The LM556/NE556 is a dual LM555. Timing is provided an external resistor and capacitor for each timing function. The two timers operate independently of each other, sharing only VCC and ground. The circuits may be triggered and reset on falling waveforms. The output structures may sink or source 200mA.

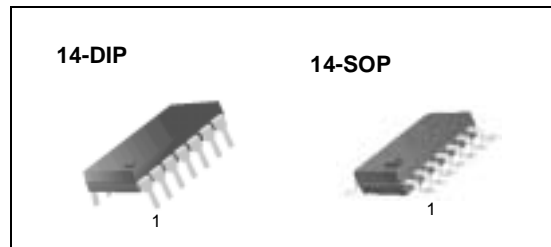

Internal Block Diagram

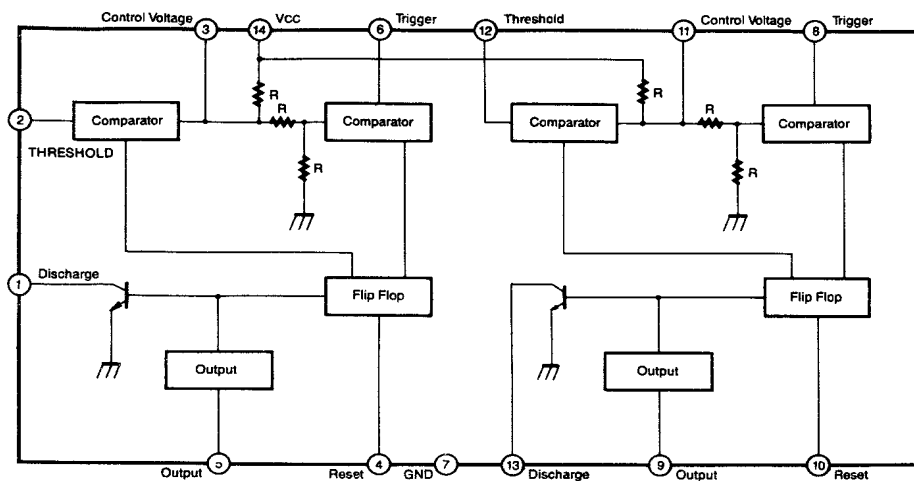

Absolute Maximum Ratings (T_A = 25°C)

Parameter	Symbol	Value	Unit
Supply Voltage	V _{CC}	16	V
Lead Temperature (soldering 10sec)	T _{LEAD}	300	°C
Power Dissipation	P _D	600	mW
Operating Temperature Range LM556/NE556	T _{OPR}	0 ~ + 70	°C
Storage Temperature Range	T _{STG}	- 65 ~ + 150	°C

Electrical Characteristics

($T_A = 25^\circ\text{C}$, $V_{CC} = 5 \sim 15\text{V}$, unless otherwise specified)

Parameter	Symbol	Conditions	Min.	Typ.	Max.	Units
Supply Voltage	V_{CC}	-	4.5	-	16	V
Supply Current *1(two timers) (low state)	I_{CC}	$V_{CC} = 5\text{V}$, $R_L = \infty$ $V_{CC} = 15\text{V}$, $R_L = \infty$	-	5 16	12 30	mA mA
Timing Error *2(monostable) Initial Accuracy Drift with Temperature Drift with Supply Voltage	ACCUR $\Delta t/\Delta T$ $\Delta t/\Delta V_{CC}$	$R_A = 2\text{K}\Omega$ to $100\text{K}\Omega$ $C = 0.1\mu\text{F}$ $T = 1.1\text{RC}$	-	0.75 50 0.1	-	% ppm/ $^\circ\text{C}$ %/V
Control Voltage	V_C	$V_{CC} = 15\text{V}$	9.0	10.0	11.0	V
		$V_{CC} = 5\text{V}$	2.6	3.33	4.0	V
Threshold Voltage	V_{TH}	$V_{CC} = 15\text{V}$	8.8	10.0	11.2	V
		$V_{CC} = 5\text{V}$	2.4	3.33	4.2	V
Threshold Current*3	I_{TH}	-	-	30	250	nA
Trigger Voltage	V_{TR}	$V_{CC} = 15\text{V}$	4.5	5.0	5.6	V
		$V_{CC} = 5\text{V}$	1.1	1.6	2.2	V
Trigger Current	I_{TR}	$V_{TR} = 0\text{V}$	-	0.01	2.0	μA
Reset Voltage*5	V_{RST}	-	0.4	0.6	1.0	V
Reset Current	I_{RST}	-	-	0.03	0.6	mA
Low Output Voltage	V_{OL}	$V_{CC} = 15\text{V}$ $I_{SINK} = 10\text{mA}$ $I_{SINK} = 50\text{mA}$ $I_{SINK} = 100\text{mA}$ $I_{SINK} = 200\text{mA}$	-	0.1 0.4 2.0 2.5	0.25 0.75 3.2	V
		$V_{CC} = 5\text{V}$ $I_{SINK} = 8\text{mA}$ $I_{SINK} = 5\text{mA}$	-	0.25 0.15	0.35 0.25	V
High Output Voltage	V_{OH}	$V_{CC} = 15\text{V}$ $I_{SOURCE} = 200\text{mA}$ $I_{SOURCE} = 100\text{mA}$	12.75	12.5 13.3	-	V
		$V_{CC} = 5\text{V}$ $I_{SOURCE} = 100\text{mA}$	2.75	3.3	-	V
Rise Time of Output	t_R	-	-	100	300	ns
Fall Time of Output	t_F	-	-	100	300	ns
Discharge Leakage Current	I_{LKG}	-	-	10	100	nA
Matching Characteristics*4 Initial Accuracy Drift with Temperature Drift with Supply Voltage	ACCUR $\Delta t/\Delta T$ $\Delta t/\Delta V_{CC}$	-	-	1.0 10 0.2	2.0 0.5	% ppm/ $^\circ\text{C}$ %/V
Timing Error (astable)*2 Initial Accuracy Drift with Temperature Drift with Supply Voltage	ACCUR $\Delta t/\Delta T$ $\Delta t/\Delta V_{CC}$	$V_{CC} = 15\text{V}$ $R_A, R_B = 1\text{K}\Omega$ to $100\text{K}\Omega$ $C = 0.1\mu\text{F}$	-	2.25 150 0.3	-	% ppm/ $^\circ\text{C}$ %/V

Notes:

*1. Supply current when output is high is typically 1.0mA less at $V_{CC} = 5\text{V}$

*2. Tested at $V_{CC} = 5\text{V}$ and $V_{CC} = 15\text{V}$

*3. This will determine the maximum value of $R_A + R_B$ for 15V operation.
The maximum total $R = 20\text{M}\Omega$, and for 5V operation the maximum total $R = 6.6\text{M}\Omega$.

*4. Matching characteristics refer to the difference between performance characteristics of each timer section in the monostable mode.

*5. As reset voltage lowers, timing is inhibited and then the output goes low.

Mechanical Dimensions

Package

14-DIP

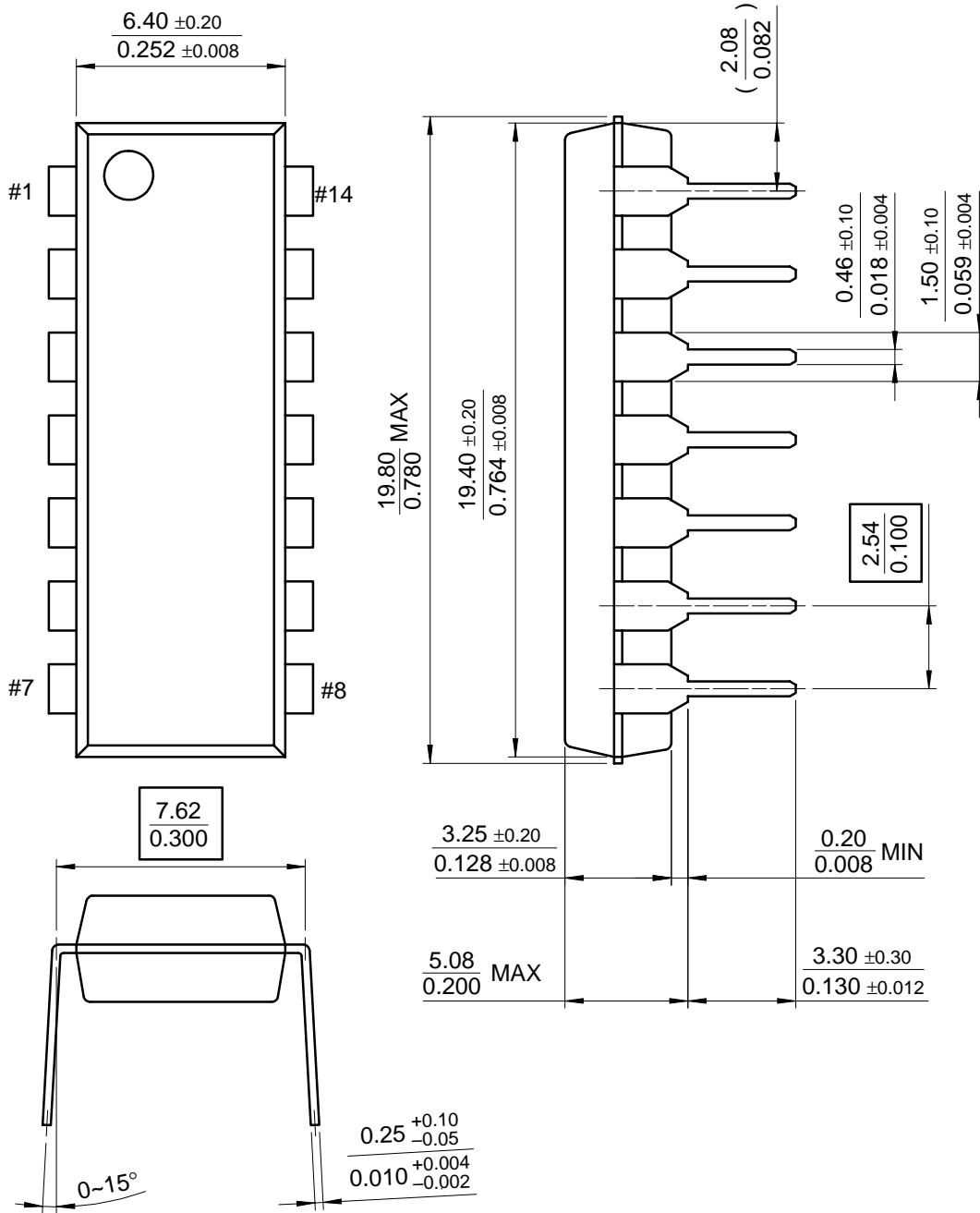

Mechanical Dimensions (Continued)

Package

14-SOP

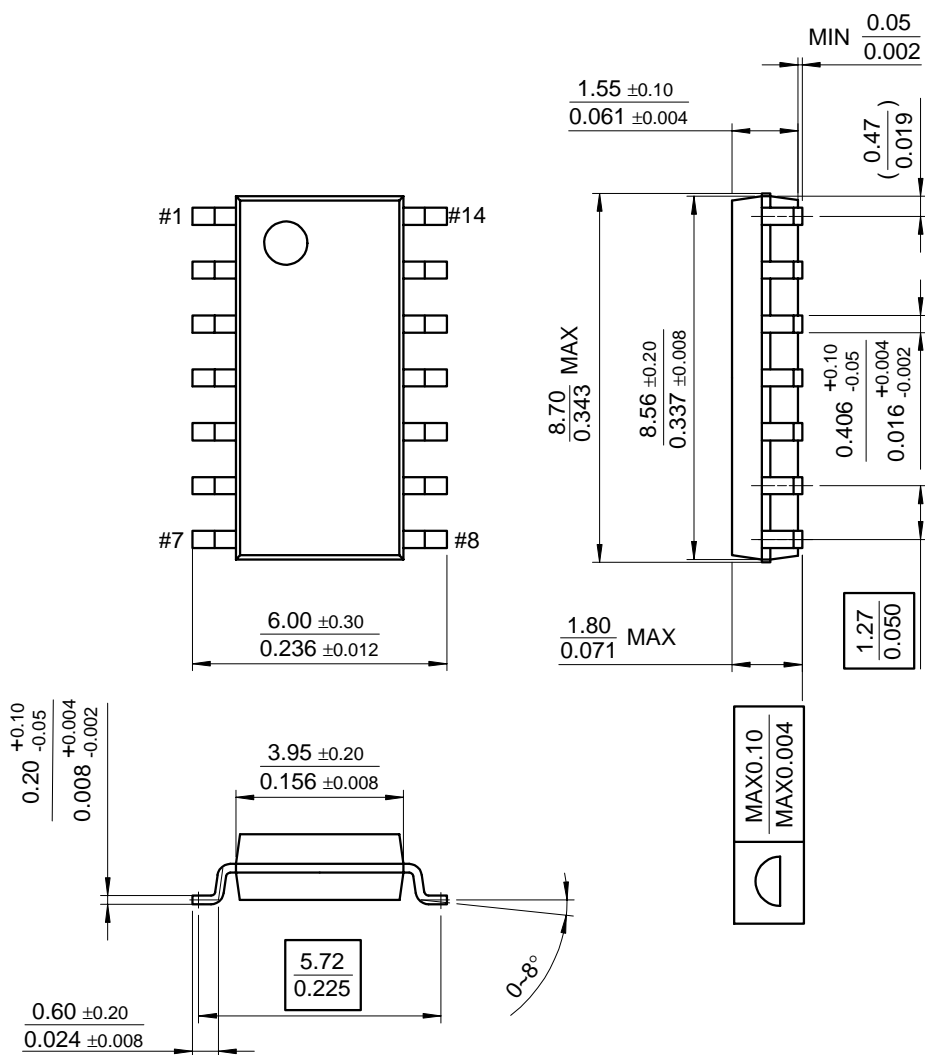

Ordering Information

Product Number	Package	Operating Temperature
LM556CN	14-DIP	0 ~ + 70°C
LM556CM	14-SOP	
NE556	14-DIP	
NE556D	14-SOP	

DISCLAIMER

FAIRCHILD SEMICONDUCTOR RESERVES THE RIGHT TO MAKE CHANGES WITHOUT FURTHER NOTICE TO ANY PRODUCTS HEREIN TO IMPROVE RELIABILITY, FUNCTION OR DESIGN. FAIRCHILD DOES NOT ASSUME ANY LIABILITY ARISING OUT OF THE APPLICATION OR USE OF ANY PRODUCT OR CIRCUIT DESCRIBED HEREIN; NEITHER DOES IT CONVEY ANY LICENSE UNDER ITS PATENT RIGHTS, NOR THE RIGHTS OF OTHERS.

LIFE SUPPORT POLICY

FAIRCHILD'S PRODUCTS ARE NOT AUTHORIZED FOR USE AS CRITICAL COMPONENTS IN LIFE SUPPORT DEVICES OR SYSTEMS WITHOUT THE EXPRESS WRITTEN APPROVAL OF THE PRESIDENT OF FAIRCHILD SEMICONDUCTOR CORPORATION. As used herein:

1. Life support devices or systems are devices or systems which, (a) are intended for surgical implant into the body, or (b) support or sustain life, and (c) whose failure to perform when properly used in accordance with instructions for use provided in the labeling, can be reasonably expected to result in a significant injury of the user.
2. A critical component in any component of a life support device or system whose failure to perform can be reasonably expected to cause the failure of the life support device or system, or to affect its safety or effectiveness.