

Distributed by:

JAMECO[®]
ELECTRONICS

www.Jameco.com ♦ 1-800-831-4242

The content and copyrights of the attached
material are the property of its owner.

Jameco Part Number 26446MOT

Quad General Purpose Transistors

NPN Silicon

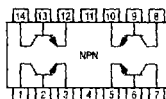

MPQ2222
MPQ2222A*

*Motorola Preferred Device

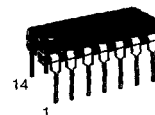

CASE 646-06, STYLE 1
TO-116

MAXIMUM RATINGS

Rating	Symbol	MPQ2222	MPQ2222A	Unit
Collector-Emitter Voltage	V_{CEO}	30	40	Vdc
Collector-Base Voltage	V_{CBO}	60		Vdc
Emitter-Base Voltage	V_{EBO}	5.0		Vdc
Collector Current -- Continuous	I_C	500		mAdc
		Each Transistor	Total Device	
Total Device Dissipation @ $T_A = 25^\circ\text{C}$ Derate above 25°C	P_D	0.65 5.2	1.9 15.2	Watts mW/ $^\circ\text{C}$
Operating and Storage Junction Temperature Range	T_J, T_{stg}	-55 to +150		$^\circ\text{C}$

THERMAL CHARACTERISTICS

Characteristic	Symbol	Max	Unit
Thermal Resistance, Junction to Ambient	$R_{\theta JA}$	66	$^\circ\text{C/W}$

ELECTRICAL CHARACTERISTICS ($T_A = 25^\circ\text{C}$ unless otherwise noted)

Characteristic	Symbol	Min	Max	Unit
----------------	--------	-----	-----	------

OFF CHARACTERISTICS

Collector-Emitter Breakdown Voltage ⁽¹⁾ ($I_C = 10 \text{ mAdc}, I_E = 0$)	MPQ2222 MPQ2222A	$V_{(BR)CEO}$	40 40	— —	Vdc
Collector-Base Breakdown Voltage ($I_C = 10 \text{ }\mu\text{Adc}, I_E = 0$)	MPQ2222 MPQ2222A	$V_{(BR)CBO}$	60 75	— —	Vdc
Emitter-Base Breakdown Voltage ($I_E = 10 \text{ }\mu\text{Adc}, I_C = 0$)	MPQ2222 MPQ2222A	$V_{(BR)EBO}$	5.0 6.0	— —	Vdc
Collector Cutoff Current ($V_{CB} = 50 \text{ Vdc}, I_E = 0$) ($V_{CB} = 60 \text{ Vdc}, I_E = 0$)	MPQ2222 MPQ2222A	I_{CBO}	— —	50 10	nAdc
Emitter Cutoff Current ($V_{EB} = 3.0 \text{ Vdc}, I_C = 0$)		I_{EBO}	—	100	nAdc

1. Pulse Test: Pulse Width $\leq 300 \mu\text{s}$, Duty Cycle $\leq 2.0\%$.

Preferred devices are Motorola recommended choices for future use and best overall value.

(Replaces MPQ2221/D)

ELECTRICAL CHARACTERISTICS ($T_A = 25^\circ\text{C}$ unless otherwise noted) (Continued)

Characteristic	Symbol	Min	Max	Unit
ON CHARACTERISTICS				
DC Current Gain ⁽¹⁾ ($I_C = 100 \mu\text{A}$, $V_{CE} = 10 \text{ Vdc}$) ($I_C = 1.0 \text{ mA}$, $V_{CE} = 10 \text{ Vdc}$) ($I_C = 10 \text{ mA}$, $V_{CE} = 10 \text{ Vdc}$) ($I_C = 150 \text{ mA}$, $V_{CE} = 10 \text{ Vdc}$) ($I_C = 300 \text{ mA}$, $V_{CE} = 10 \text{ Vdc}$) ($I_C = 500 \text{ mA}$, $V_{CE} = 10 \text{ Vdc}$)	h_{FE}	35 50 75 100 30 40	— — — 300 — —	—
Collector–Emitter Saturation Voltage ($I_C = 150 \text{ mA}$, $I_B = 15 \text{ mA}$) ($I_C = 300 \text{ mA}$, $I_B = 30 \text{ mA}$) ($I_C = 500 \text{ mA}$, $I_B = 50 \text{ mA}$)	$V_{CE(sat)}$	— — —	0.4 0.3 1.6 1.0	Vdc
Base–Emitter Saturation Voltage ($I_C = 150 \text{ mA}$, $I_B = 15 \text{ mA}$) ($I_C = 300 \text{ mA}$, $I_B = 30 \text{ mA}$) ($I_C = 500 \text{ mA}$, $I_B = 50 \text{ mA}$)	$V_{BE(sat)}$	— 0.6 —	1.3 1.2 2.6 2.0	Vdc

SMALL–SIGNAL CHARACTERISTICS

Current–Gain – Bandwidth Product ⁽¹⁾ ($I_C = 20 \text{ mA}$, $V_{CE} = 20 \text{ Vdc}$, $f = 100 \text{ MHz}$)	f_T	200	—	MHz
Output Capacitance ($V_{CB} = 10 \text{ Vdc}$, $I_E = 0$, $f = 1.0 \text{ MHz}$)	C_{obo}	—	8.0	pF
Input Capacitance ($V_{EB} = 0.5 \text{ Vdc}$, $I_C = 0$, $f = 1.0 \text{ MHz}$)	C_{ibo}	—	30	pF

SWITCHING CHARACTERISTICS

Turn–On Time ($V_{CC} = 30 \text{ Vdc}$, $V_{BE(off)} = -0.5 \text{ Vdc}$, $I_C = 150 \text{ mA}$, $I_{B1} = 15 \text{ mA}$)	t_{on}	—	35	ns
Turn–Off Time ($V_{CC} = 30 \text{ Vdc}$, $I_C = 150 \text{ mA}$, $I_{B1} = I_{B2} = 15 \text{ mA}$)	t_{off}	—	285	ns

1. Pulse Test: Pulse Width $\leq 300 \mu\text{s}$, Duty Cycle $\leq 2.0\%$.

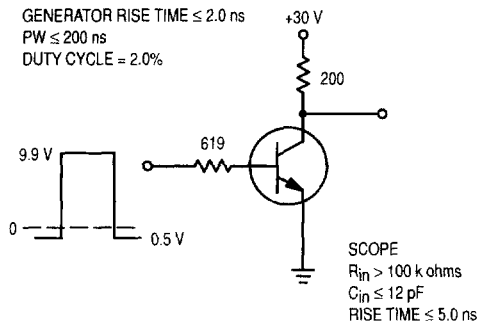

Figure 1. Delay and Rise Time Equivalent Test Circuit

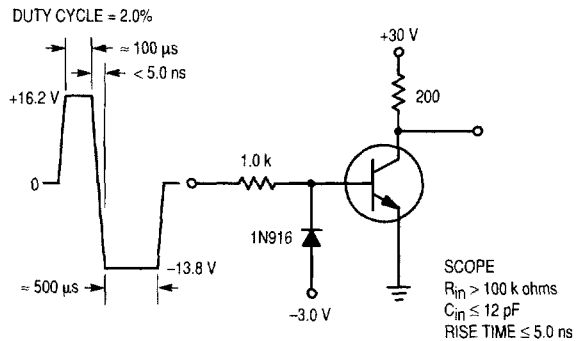

Figure 2. Storage Time and Fall Time Equivalent Test Circuit

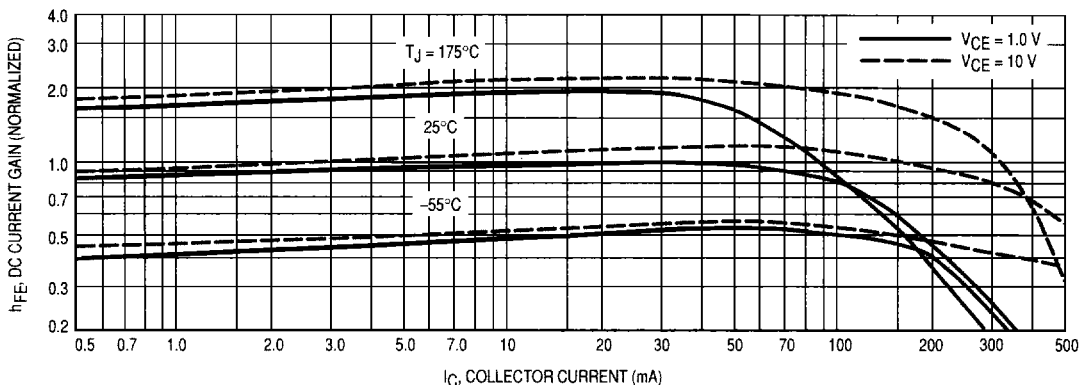

Figure 3. Normalized DC Current Gain

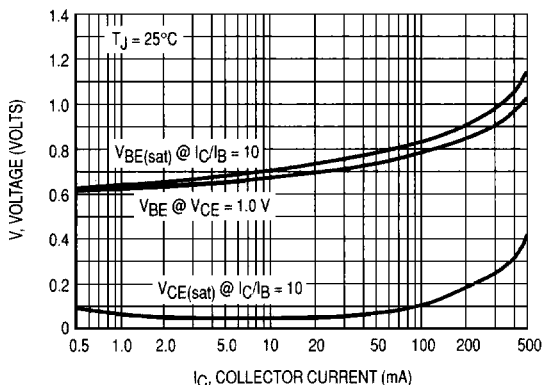

Figure 4. "ON" Voltages

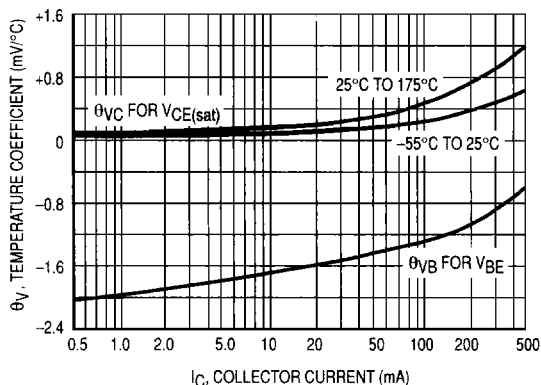

Figure 5. Temperature Coefficients

NOISE FIGURE
($V_{CE} = 10\text{ Vdc}$, $T_A = 25^\circ\text{C}$)

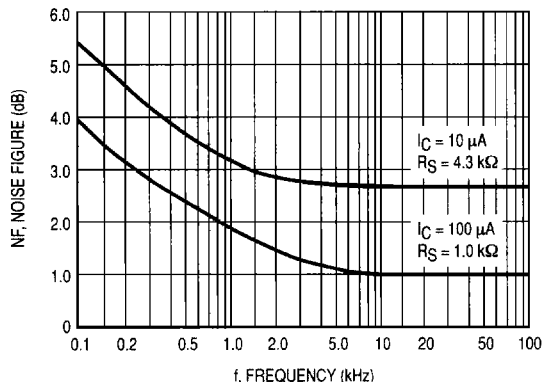

Figure 6. Frequency Effects

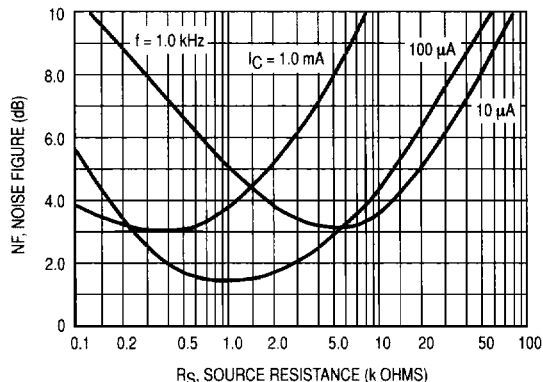

Figure 7. Source Resistance Effects

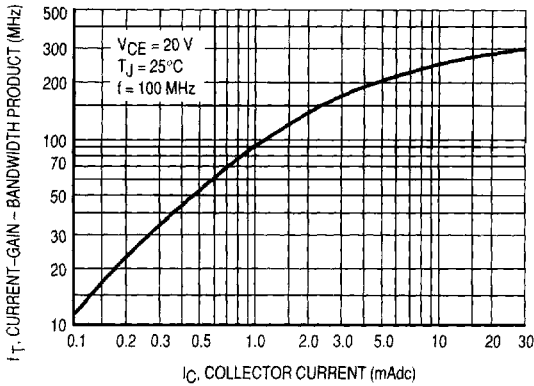

Figure 8. Current-Gain — Bandwidth Product

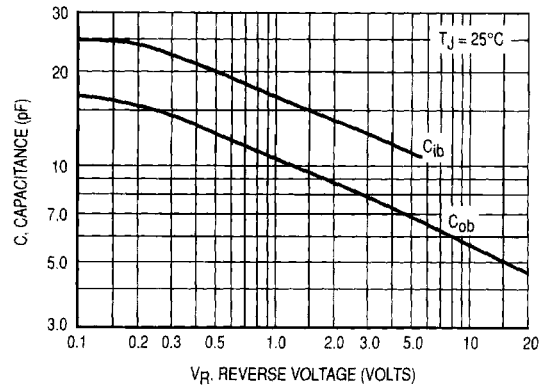

Figure 9. Capacitances

SWITCHING TIME CHARACTERISTICS

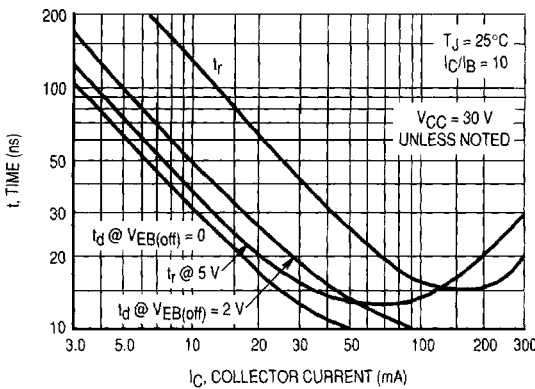

Figure 10. Turn-On Time

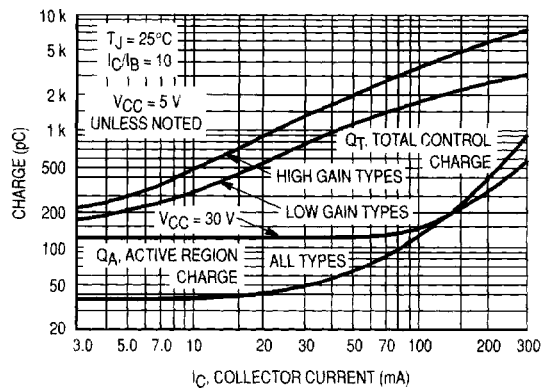

Figure 11. Charge Data

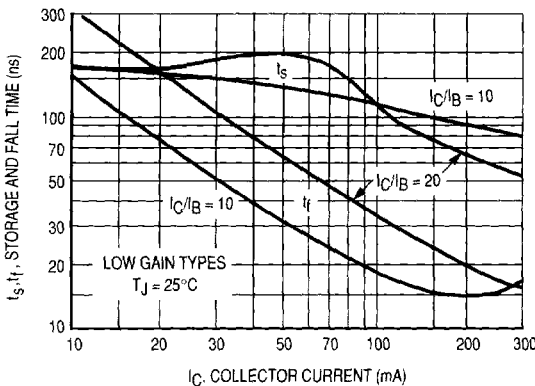

Figure 12. Turn-Off Behavior

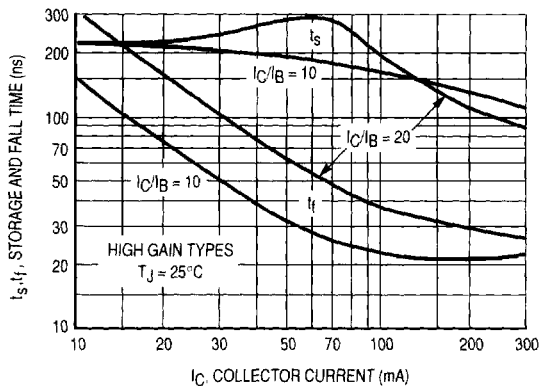

Figure 13. Turn-Off Behavior

MPQ2222 MPQ2222A

GENERATOR RISE TIME ≤ 2.0 ns
PW ≤ 200 ns
DUTY CYCLE = 2.0%

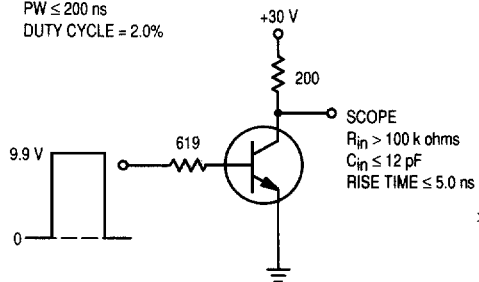

Figure 14. Delay and Rise Time Equivalent Test Circuit

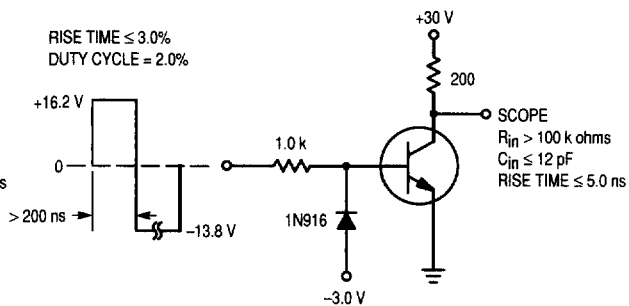

Figure 15. Storage Time and Fall Time Equivalent Test Circuit