

Distributed by:

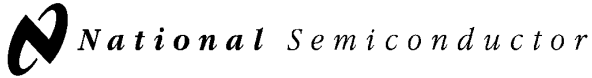

www.Jameco.com ♦ 1-800-831-4242

The content and copyrights of the attached material are the property of its owner.



April 1989

27C64

65,536-Bit (8,192 x 8) UV Erasable CMOS PROM Military Qualified

General Description

The 27C64 is a high-speed 64K UV erasable and electrically reprogrammable CMOS EPROM, ideally suited for applications where fast turnaround, pattern experimentation and low power consumption are important requirements.

The 27C64 is designed to operate with a single +5V power supply with $\pm 10\%$ tolerance. The CMOS design allows the part to operate over Military Temperature Ranges.

The 27C64 is packaged in a 28-pin dual-in-line package with transparent lid and a 32-pin windowed LCC. The transparent lid allows the user to expose the chip to ultraviolet light to erase the bit pattern. A new pattern can then be written electrically into the device by following the programming procedure.

This EPROM is fabricated with National's proprietary, time proven CMOS double-poly silicon gate technology which combines high performance and high density with low power consumption and excellent reliability.

The 27C64 specified on this data sheet is fully compliant with MIL-STD-883, Revision C.

Features

- Clocked sense amps for fast access time down to 200 ns
- Low CMOS power consumption
 - Active Power: 55 mW max
 - Standby Power: 0.55 mW max
- Performance compatible to NSC800™ CMOS micro-processor
- Single 5V power supply
- Pin compatible with NMOS 64K EPROMs
- Fast and reliable programming
- Static operation—no clocks required
- TTL, CMOS compatible inputs/outputs
- TRI-STATE® output
- Optimum EPROM for total CMOS systems
- Manufacturer's identification code for automatic programming control
- Windowed DIP and LCC Package Options
- Specifications guaranteed over full military temperature range (-55°C to $+125^{\circ}\text{C}$)
- This device is processed in compliance with SMD85102, and the DIP version is dual marked

Block Diagram

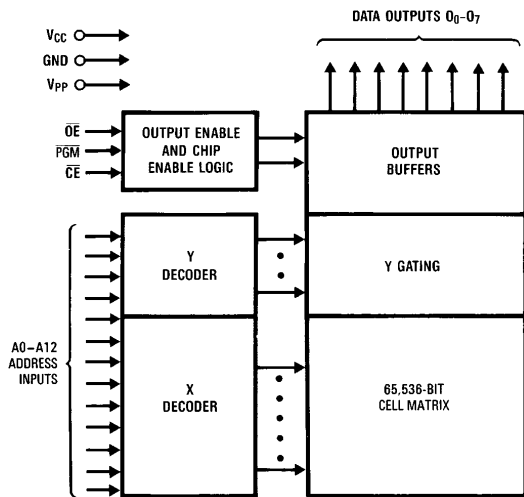

TL/D/10331-1

Pin Names

A0-A12	Addresses
$\overline{\text{CE}}$	Chip Enable
$\overline{\text{OE}}$	Output Enable
O ₀ -O ₇	Outputs
PGM	Program
NC	No Connect

TRI-STATE® is a registered trademark of National Semiconductor Corporation.
NSC800™ is a trademark of National Semiconductor Corporation.

Connection Diagram

27C512	27C256	27C128	27C32	27C16
27512	27256	27128	2732	2716
A15	V _{PP}	V _{PP}		
A12	A12	A12		
A7	A7	A7	A7	A7
A6	A6	A6	A6	A6
A5	A5	A5	A5	A5
A4	A4	A4	A4	A4
A3	A3	A3	A3	A3
A2	A2	A2	A2	A2
A1	A1	A1	A1	A1
A0	A0	A0	A0	A0
O0	O0	O0	O0	O0
O1	O1	O1	O1	O1
O2	O2	O2	O2	O2
GND	GND	GND	GND	GND

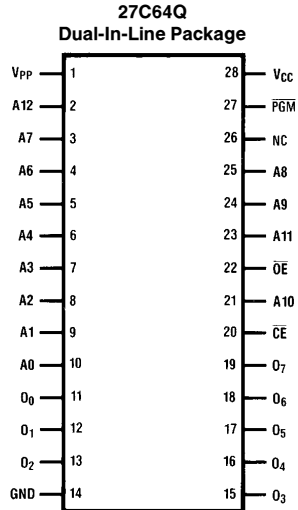

27C16	27C32	27C128	27C256	27C512
2716	2732	27128	27256	27512
		V _{CC}	V _{CC}	V _{CC}
		PGM	A14	A14
V _{CC}	V _{CC}	A13	A13	A13
A8	A8	A8	A8	A8
A9	A9	A9	A9	A9
V _{PP}	A11	A11	A11	A11
OE	OE/V _{PP}	OE	OE	OE/V _{PP}
A10	A10	A10	A10	A10
CE/PGM	CE	CE	CE/PGM	CE
O7	O7	O7	O7	O7
O6	O6	O6	O6	O6
O5	O5	O5	O5	O5
O4	O4	O4	O4	O4
O3	O3	O3	O3	O3

TL/D/10331-2

Note: Socket compatible EPROM pin configurations are shown in the blocks adjacent to the 27C64 pins.

NS Package Number J28AQ

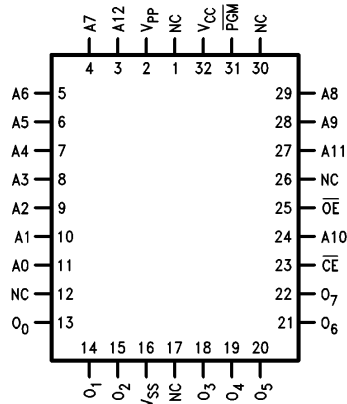

TL/D/10331-6

Top View

NS Package Number EA32CQ

Military Temp Range (-55°C to +125°C)

V_{CC} = 5V ± 10%

Parameter/Order Number	Access Time (ns)
27C64Q350/883	350
27C64Q250/883	250
27C64Q200/883	200
27C64E350/883	350
27C64E250/883	250
27C64E200/883	200

Absolute Maximum Ratings (Note 1)

Temperature under Bias	-55°C to +125°C	V _{CC} Supply Voltage with Respect to Ground	+7.0V to -0.6V
Storage Temperature	-65°C to +150°C	Power Dissipation	1.0W
All Input Voltages except A9 with Respect to Ground (Note 10)	+6.5V to -0.6V	Lead Temperature (Soldering, 10 sec.)	300°C
All Output Voltages with Respect to Ground (Note 10)	V _{CC} + 1.0V to GND - 0.6V	ESD Rating (Mil Spec 883C, Method 3015.2)	2000V
V _{PP} Supply Voltage and A9 with Respect to Ground during Programming	+14.0V to -0.6V	Operating Conditions (Note 7)	
		Temperature Range (T _{case})	-55°C to +125°C
		V _{CC} Power Supply	+5V ± 10%

READ OPERATION

DC Electrical Characteristics

Symbol	Parameter	Conditions	Min	Typ	Max	Units
I _{LI}	Input Load Current	V _{IN} = V _{CC} or GND			10	μA
I _{LO}	Output Leakage Current	V _{OUT} = V _{CC} or GND, $\overline{CE} = V_{IH}$			10	μA
I _{CC1} (Note 9)	V _{CC} Current (Active) TTL Inputs	$\overline{CE} = V_{IL}$, f = 5 MHz Inputs = V _{IH} or V _{IL} , I/O = 0 mA		5	20	mA
I _{CC2} (Note 9)	V _{CC} Current (Active) CMOS Inputs	$\overline{CE} = GND$, f = 5 MHz Inputs = V _{CC} or GND, I/O = 0 mA		3	10	mA
I _{CCSB1}	V _{CC} Current (Standby) TTL Inputs	$\overline{CE} = V_{IH}$		0.1	1	mA
I _{CCSB2}	V _{CC} Current (Standby) CMOS Inputs	$\overline{CE} = V_{CC}$		0.5	100	μA
I _{PP}	V _{PP} Load Current	V _{PP} = V _{CC}			100	μA
V _{IL}	Input Low Voltage		-0.1		0.8	V
V _{IH}	Input High Voltage		2.0		V _{CC} + 1	V
V _{OL1}	Output Low Voltage	I _{OL} = 2.1 mA			0.45	V
V _{OH1}	Output High Voltage	I _{OH} = -400 μA	2.4			V
V _{OL2}	Output Low Voltage	I _{OL} = 0 μA			0.1	V
V _{OH2}	Output High Voltage	I _{OH} = 0 μA	4.4			V

AC Electrical Characteristics

Symbol	Parameter	Conditions	27C64						Units
			200		250		350		
			Min	Max	Min	Max	Min	Max	
t _{ACC}	Address to Output Delay	$\overline{CE} = \overline{OE} = V_{IL}$ PGM = V _{IH}		200		250		350	ns
t _{CE}	\overline{CE} to Output Delay	$\overline{OE} = V_{IL}$, PGM = V _{IH}		200		250		350	ns
t _{OE}	\overline{OE} to Output Delay	$\overline{CE} = V_{IL}$, PGM = V _{IH}		60		70		120	ns
t _{DF}	\overline{OE} High to Output Float	$\overline{CE} = V_{IL}$, PGM = V _{IH}	0	55	0	55	0	105	ns
t _{OH}	Output Hold from Addresses, \overline{CE} or \overline{OE} , Whichever Occurred First	$\overline{CE} = \overline{OE} = V_{IL}$ PGM = V _{IH}	0		0		0		ns

Capacitance $T_A = +25^\circ\text{C}$, $f = 1\text{ MHz}$ (Note 2)

Symbol	Parameter	Conditions	Typ	Max	Units
C_{IN}	Input Capacitance	$V_{IN} = 0\text{V}$	6	10	pF
C_{OUT}	Output Capacitance	$V_{OUT} = 0\text{V}$	9	12	pF

AC Test Conditions

Output Load	1 TTL Gate and $C_L = 100\text{ pF}$ (Note 8)	Timing Measurement Reference Level	0.8V and 2V
Input Rise and Fall Times	$\leq 5\text{ ns}$	Inputs	0.8V and 2V
Input Pulse Levels	0.45V to 2.4V	Outputs	

AC Waveforms (Notes 6 & 9)

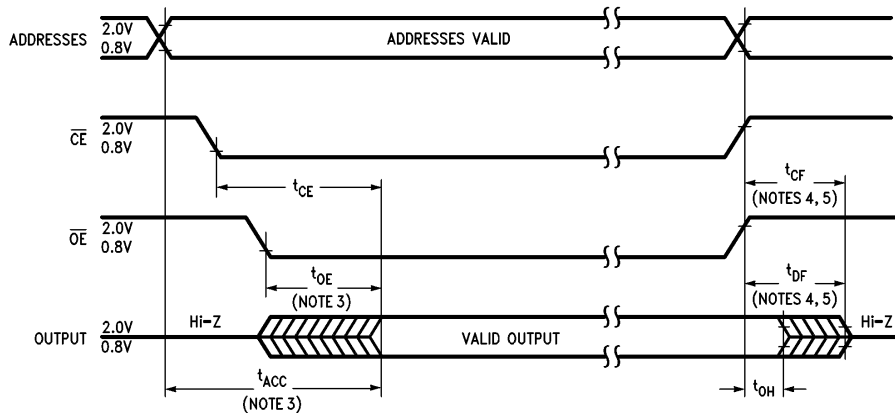

TL/D/10331-3

Note 1: Stresses above those listed under "Absolute Maximum Ratings" may cause permanent damage to the device. This is a stress rating only and functional operation of the device at these or any other conditions above those indicated in the operational sections of this specification is not implied. Exposure to absolute maximum rating conditions for extended periods may affect device reliability.

Note 2: This parameter is only sampled and is not 100% tested.

Note 3: \overline{OE} may be delayed up to $t_{ACC} - t_{OE}$ after the falling edge of \overline{CE} without impacting t_{ACC} .

Note 4: The t_{DF} and t_{CF} compare level is determined as follows:
High to TRI-STATE, the measured V_{OH1} (DC) $- 0.10\text{V}$;
Low to TRI-STATE, the measured V_{OL1} (DC) $+ 0.10\text{V}$.

Note 5: TRI-STATE may be attained using \overline{OE} or \overline{CE} .

Note 6: The power switching characteristics of EPROMs require careful device decoupling. It is recommended that at least a $0.1\text{ }\mu\text{F}$ ceramic capacitor be used on every device between V_{CC} and GND.

Note 7: The outputs must be restricted to $V_{CC} + 1.0\text{V}$ to avoid latch-up and device damage.

Note 8: 1 TTL Gate: $I_{OL} = 1.6\text{ mA}$, $I_{OH} = -400\text{ }\mu\text{A}$.
 C_L : 100 pF includes fixture capacitance.

Note 9: V_{PP} may be connected to V_{CC} except during programming.

Note 10: Inputs and outputs can undershoot to -2.0V for 20 ns Max.

Programming Characteristics (Notes 1, 2, 3 & 4)

Symbol	Parameter	Conditions	Min	Typ	Max	Units
t_{AS}	Address Setup Time		2			μs
t_{OES}	\overline{OE} Setup Time		2			μs
t_{CES}	\overline{CE} Setup Time		2			μs
t_{DS}	Data Setup Time		2			μs
t_{VPS}	V_{PP} Setup Time		2			μs
t_{VCS}	V_{CC} Setup Time		2			μs
t_{AH}	Address Hold Time		0			μs
t_{DH}	Data Hold Time		2			μs
t_{DF}	Output Enable to Output Float Delay	$\overline{CE} = V_{IL}$	0		130	ns
t_{PW}	Program Pulse Width		0.45	0.5	0.55	ms
t_{OE}	Data Valid from \overline{OE}	$\overline{CE} = V_{IL}$			150	ns
I_{PP}	V_{PP} Supply Current during Programming Pulse	$\overline{CE} = V_{IL}$ $\overline{PGM} = V_{IL}$			30	mA
I_{CC}	V_{CC} Supply Current				10	mA
T_A	Temperature Ambient		20	25	30	$^{\circ}C$
V_{CC}	Power Supply Voltage		5.75	6.0	6.25	V
V_{PP}	Programming Supply Voltage		12.2	13.0	13.3	V
t_{FR}	Input Rise, Fall Time		5			ns
V_{IL}	Input Low Voltage			0.0	0.45	V
V_{IH}	Input High Voltage		2.4	4.0		V
t_{IN}	Input Timing Reference Voltage		0.8	1.5	2.0	V
t_{OUT}	Output Timing Reference Voltage		0.8	1.5	2.0	V

Programming Waveforms (Note 3)

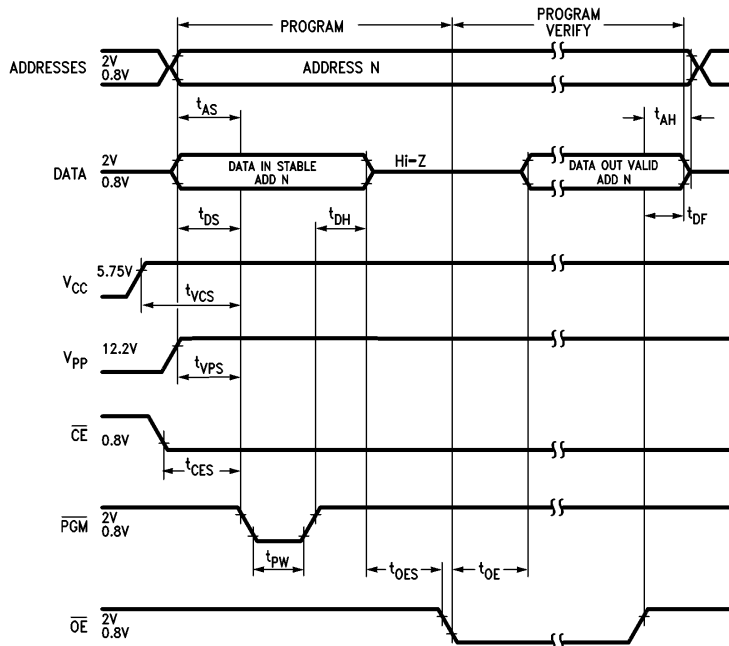

TL/D/10331-4

Note 1: National's standard product warranty applies to devices programmed to specifications described herein.

Note 2: V_{CC} must be applied simultaneously or before V_{PP} and removed simultaneously or after V_{PP}. The EPROM must not be inserted into or removed from a board with voltage applied to V_{PP} or V_{CC}.

Note 3: The maximum absolute allowable voltage which may be applied to the V_{PP} pin during programming is 14V. Care must be taken when switching the V_{PP} supply to prevent any overshoot from exceeding this 14V maximum specification. At least a 0.1 μF capacitor is required across V_{PP}, V_{CC} to GND to suppress spurious voltage transients which may damage the device.

Note 4: Programming and program verify are tested with the interactive Program Algorithm, at typical power supply voltages and timings. The min and max limit parameters are design parameters, not tested or guaranteed.

Interactive Programming Algorithm Flow Chart

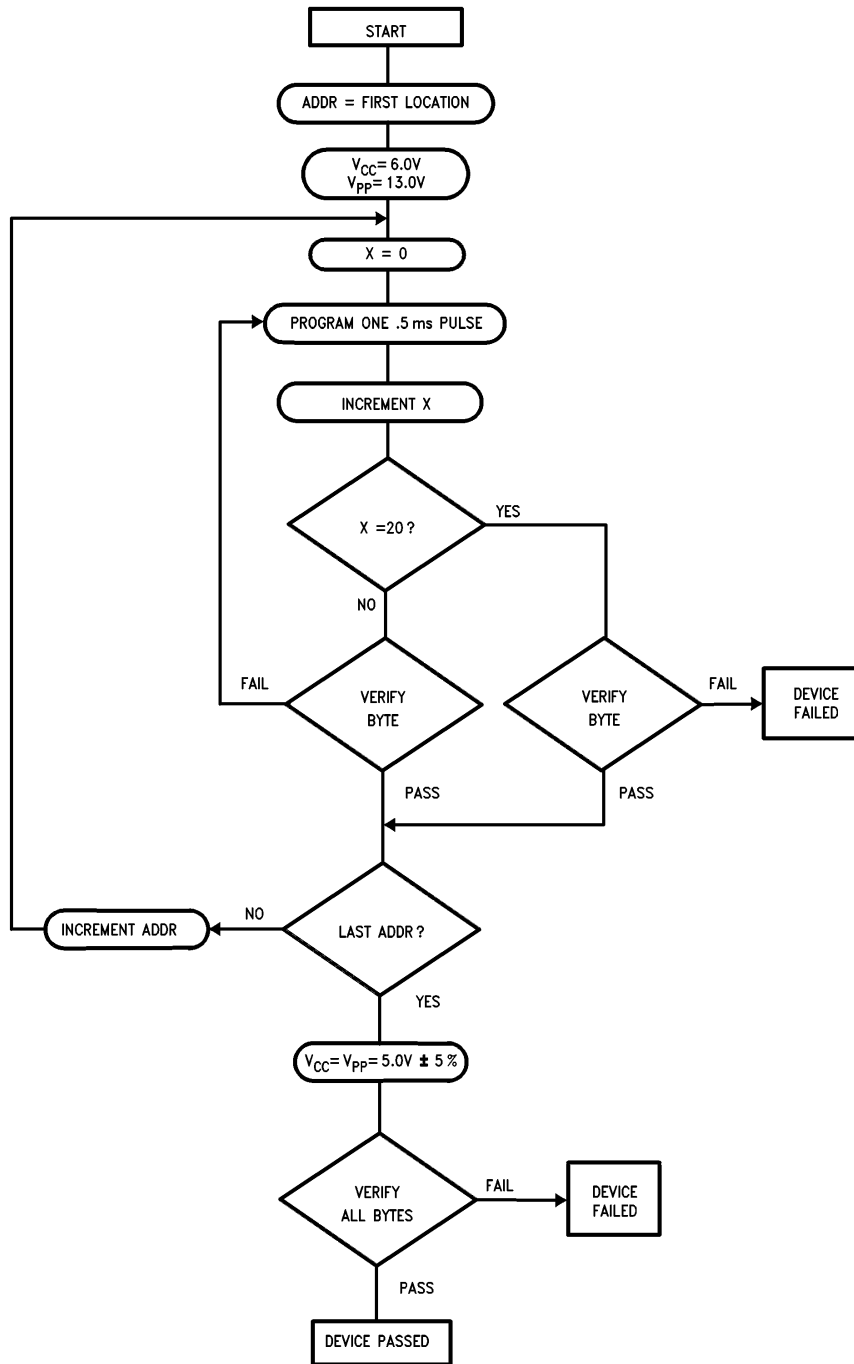

TL/D/10331-5

Functional Description

DEVICE OPERATION

The six modes of operation of the 27C64 are listed in Table I. It should be noted that all inputs for the six modes are at TTL levels. The power supplies required are V_{CC} and V_{PP} . The V_{PP} power supply must be at 13.0V during the three programming modes, and must be at 5V in the other three modes. The V_{CC} power supply must be at 6V during the three programming modes, and at 5V in the other three modes.

Read Mode

The 27C64 has two control functions, both of which must be logically active in order to obtain data at the outputs. Chip Enable (\overline{CE}) is the power control and should be used for device selection. Output Enable (\overline{OE}) is the output control and should be used to gate data to the output pins, independent of device selection. The programming pin (\overline{PGM}) should be at V_{IH} except during programming. Assuming that addresses are stable, address access time (t_{ACC}) is equal to the delay from \overline{CE} to output (t_{CE}). Data is available at the outputs t_{OE} after the falling edge of \overline{OE} , assuming that \overline{CE} has been low and addresses have been stable for at least $t_{ACC}-t_{OE}$.

The sense amps are clocked for fast access time. V_{CC} should therefore be maintained at operating voltage during read and verify. If V_{CC} temporarily drops below the spec. voltage (but not to ground) an address transition must be performed after the drop to insure proper output data.

Standby Mode

The 27C64 has a standby mode which reduces the active power dissipation by 99%, from 55 mW to 0.55 mW. The 27C64 is placed in the standby mode by applying a CMOS high signal to the \overline{CE} input. When in standby mode, the outputs are in a high impedance state, independent of the \overline{OE} input.

Output OR-Tying

Because 27C64s are usually used in larger memory arrays, National has provided a 2-line control function that accommodates this use of multiple memory connections. The 2-line control function allows for:

- the lowest possible memory power dissipation, and
- complete assurance that output bus contention will not occur.

To most efficiently use these two control lines, it is recommended that \overline{CE} (pin 20) be decoded and used as the primary device selecting function, while \overline{OE} (pin 22) be made a common connection to all devices in the array and connected to the READ line from the system control bus. This assures that all deselected memory devices are in their low power standby modes and that the output pins are active only when data is desired from a particular memory device.

Programming

CAUTION: Exceeding 14V on pin 1 (V_{PP}) will damage the 27C64.

Initially, all bits of the 27C64 are in the "1" state. Data is introduced by selectively programming "0s" into the desired bit locations. Although only "0s" will be programmed, both "1s" and "0s" can be presented in the data word. A "0" cannot be changed to a "1" once the bit has been programmed.

The 27C64 is in the programming mode when the V_{PP} power supply is at 13.0V and \overline{OE} is at V_{IH} . It is required that at least a 0.1 μ F capacitor be placed across V_{PP} , V_{CC} to ground to suppress spurious voltage transients which may damage the device. The data to be programmed is applied 8 bits in parallel to the data output pins. The levels required for the address and data inputs are TTL.

For programming, \overline{CE} should be kept TTL low at all times while V_{PP} is kept at 13.0V.

When the address and data are stable, an active low, TTL program pulse is applied to the \overline{PGM} input. A program pulse must be applied at each address location to be programmed. The 27C64 is designed to be programmed with interactive programming, where each address is programmed with a series of 0.5 ms pulses until it verifies (up to a maximum of 20 pulses or 10 ms). The 27C64 must not be programmed with a DC signal applied to the \overline{PGM} input.

Programming multiple 27C64s in parallel with the same data can be easily accomplished due to the simplicity of the programming requirements. Like inputs of the paralleled 27C64s may be connected together when they are programmed with the same data. A low level TTL pulse applied to the \overline{PGM} input programs the paralleled 27C64s.

TABLE I. Mode Selection

Mode	Pins	\overline{CE} (20)	\overline{OE} (22)	\overline{PGM} (27)	V_{PP} (1)	V_{CC} (28)	Outputs (11–13, 15–19)
Read		V_{IL}	V_{IL}	V_{IH}	5V	5V	D_{OUT}
Standby		V_{IH}	Don't Care	Don't Care	5V	5V	Hi-Z
Output Disable		Don't Care	V_{IH}	V_{IH}	5V	5V	Hi-Z
Program		V_{IL}	V_{IH}		13V	6V	D_{IN}
Program Verify		V_{IL}	V_{IL}	V_{IH}	13V	6V	D_{OUT}
Program Inhibit		V_{IH}	Don't Care	Don't Care	13V	6V	Hi-Z

Functional Description (Continued)

Program Inhibit

Programming multiple 27C64s in parallel with different data is also easily accomplished. Except for \overline{CE} all like inputs (including \overline{OE} and \overline{PGM}) of the parallel 27C64 may be common. A TTL low level program pulse applied to an 27C64's PGM input with \overline{CE} at V_{IL} and V_{PP} at 13.0V will program that 27C64. A TTL high level \overline{CE} input inhibits the other 27C64s from being programmed.

Program Verify

A verify should be performed on the programmed bits to determine whether they were correctly programmed. The verify may be performed with V_{PP} at 13.0V. V_{PP} must be at V_{CC} , except during programming and program verify.

MANUFACTURER'S IDENTIFICATION CODE

The 27C64 has a manufacturer's identification code to aid in programming. The code, shown in Table II, is two bytes wide and is stored in a ROM configuration on the chip. It identifies the manufacturer and the device type. The code for the 27C64 is "8FC2", where "8F" designates that it is made by National Semiconductor, and "C2" designates a 64k part.

The code is accessed by applying $12V \pm 0.5V$ to address pin A9. Addresses A1–A8, A10–A12, \overline{CE} , and \overline{OE} are held at V_{IL} . Address A0 is held at V_{IL} for the manufacturer's code, and at V_{IH} for the device code. The code is read out on the 8 data pins. Proper code access is only guaranteed at $25^{\circ}C \pm 5^{\circ}C$.

The primary purpose of the manufacturer's identification code is automatic programming control. When the device is inserted in a EPROM programmer socket, the programmer reads the code and then automatically calls up the specific programming algorithm for the part. This automatic programming control is only possible with programmers which have the capability of reading the code.

ERASURE CHARACTERISTICS

The erasure characteristics of the 27C64 are such that erasure begins to occur when exposed to light with wavelengths shorter than approximately 4000 Angstroms (\AA). It should be noted that sunlight and certain types of fluorescent lamps have wavelengths in the 3000 \AA –4000 \AA range.

After programming, opaque labels should be placed over the 27C64's window to prevent unintentional erasure. Covering the window will also prevent temporary functional failure due to the generation of photo currents.

The recommended erasure procedure for the 27C64 is exposure to short wave ultraviolet light which has a wavelength of 2537 Angstroms (\AA). The integrated dose (i.e., UV intensity x exposure time) for erasure should be a minimum of 15W-sec/cm².

The 27C64 should be placed within 1 inch of the lamp tubes during erasure. Some lamps have a filter on their tubes which should be removed before erasure. Table III shows the minimum 27C64 erasure time for various light intensities.

An erasure system should be calibrated periodically. The distance from lamp to unit should be maintained at one inch. The erasure time increases as the square of the distance. (If distance is doubled the erasure time increases by a factor of 4.) Lamps lose intensity as they age. When a lamp is changed, the distance has changed or the lamp has aged, the system should be checked to make certain full erasure is occurring. Incomplete erasure will cause symptoms that can be misleading. Programmers, components, and even system designs have been erroneously suspected when incomplete erasure was the problem.

SYSTEM CONSIDERATION

The power switching characteristics of EPROMs require careful decoupling of the devices. The supply current, I_{CC} , has three segments that are of interest to the system designer—the standby current level, the active current level, and the transient current peaks that are produced by voltage transitions on input pins. The magnitude of these transient current peaks is dependent on the output capacitance loading of the device. The associated V_{CC} transient voltage peaks can be suppressed by properly selected decoupling capacitors. It is recommended that at least a 0.1 μF ceramic capacitor be used on every device between V_{CC} and GND. This should be a high frequency capacitor of low inherent inductance. In addition, at least a 4.7 μF bulk electrolytic capacitor should be used between V_{CC} and GND for each eight devices. The bulk capacitor should be located near where the power supply is connected to the array. The purpose of the bulk capacitor is to overcome the voltage drop caused by the inductive effects of the PC board traces.

TABLE II. Manufacturer's Identification Code

Pins	A0 (10)	O7 (19)	O6 (18)	O5 (17)	O4 (16)	O3 (15)	O2 (13)	O1 (12)	O0 (11)	Hex Data
Manufacturer Code	V_{IL}	1	0	0	0	1	1	1	1	8F
Device Code	V_{IH}	1	1	0	0	0	0	1	0	C2

TABLE III. Minimum 27C64 Erasure Time

Light Intensity (Micro-Watts/cm ²)	Erasure Time (Minutes)
15,000	20
10,000	25
5,000	50



Physical Dimensions inches (millimeters)

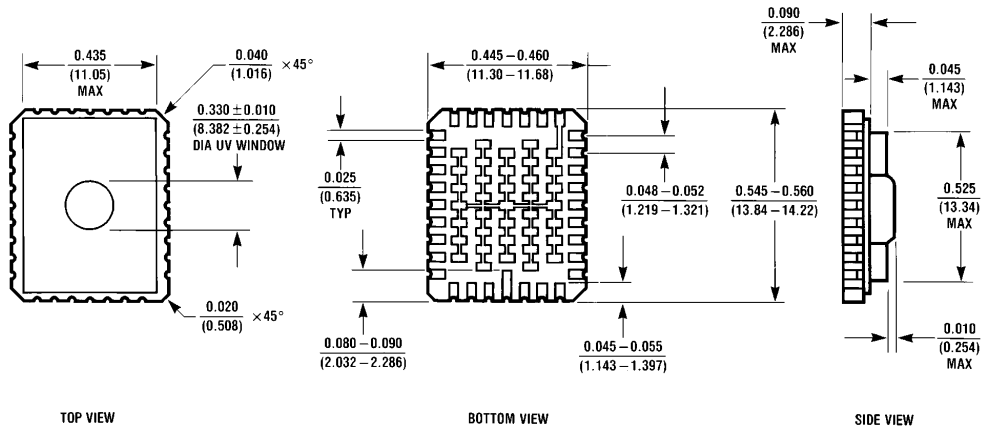

EA32CQ (REV A)

32L Leadless Chip Carrier (E)
Order Number 27C64E350/883, 27C64E250/883 or 27C64E200/883
NS Package Number EA32CQ

Physical Dimensions inches (millimeters) (Continued)

Lit. # 114710

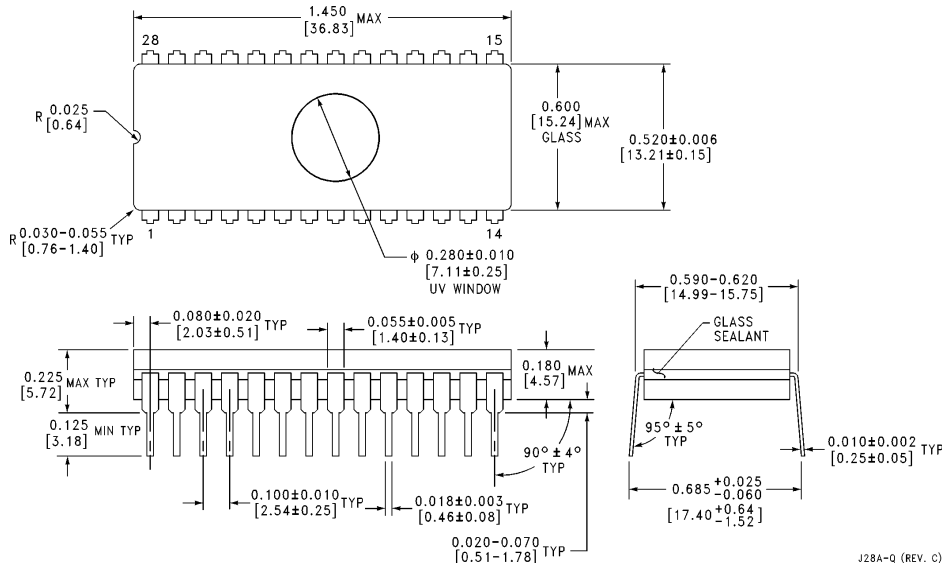

28 Lead EPROM Dual-In-Line Package (JQ) Small Window
Order Number 27C64Q350/883, 27C64Q250/883 or 27C64Q200/883
NS Package Number J28AQ

J28A-Q (REV. C)

LIFE SUPPORT POLICY

NATIONAL'S PRODUCTS ARE NOT AUTHORIZED FOR USE AS CRITICAL COMPONENTS IN LIFE SUPPORT DEVICES OR SYSTEMS WITHOUT THE EXPRESS WRITTEN APPROVAL OF THE PRESIDENT OF NATIONAL SEMICONDUCTOR CORPORATION. As used herein:

1. Life support devices or systems are devices or systems which, (a) are intended for surgical implant into the body, or (b) support or sustain life, and whose failure to perform, when properly used in accordance with instructions for use provided in the labeling, can be reasonably expected to result in a significant injury to the user.
2. A critical component is any component of a life support device or system whose failure to perform can be reasonably expected to cause the failure of the life support device or system, or to affect its safety or effectiveness.

 <p>National Semiconductor Corporation 1111 West Bardin Road Arlington, TX 76017 Tel: 1(800) 272-9959 Fax: 1(800) 737-7018</p>	<p>National Semiconductor Europe Fax: (+49) 0-180-530 85 86 Email: onjwge@tevm2.nsc.com Deutsch Tel: (+49) 0-180-530 85 85 English Tel: (+49) 0-180-532 78 32 Français Tel: (+49) 0-180-532 93 58 Italiano Tel: (+49) 0-180-534 16 80</p>	<p>National Semiconductor Hong Kong Ltd. 19th Floor, Straight Block, Ocean Centre, 5 Canton Rd. Tsimshatsui, Kowloon Hong Kong Tel: (852) 2737-1600 Fax: (852) 2736-9960</p>	<p>National Semiconductor Japan Ltd. Tel: 81-043-299-2309 Fax: 81-043-299-2408</p>
--	--	---	---

National does not assume any responsibility for use of any circuitry described, no circuit patent licenses are implied and National reserves the right at any time without notice to change said circuitry and specifications.