

Distributed by:



[www.Jameco.com](http://www.Jameco.com) ♦ 1-800-831-4242

The content and copyrights of the attached material are the property of its owner.

H11A1X, H11A2X, H11A3X, H11A4X, H11A5X  
**H11A1**, H11A2, H11A3, H11A4, H11A5



**OPTICALLY COUPLED  
 ISOLATOR  
 PHOTOTRANSISTOR OUTPUT**

**APPROVALS**

- UL recognised, File No. E91231
- 'X' SPECIFICATION APPROVALS**
- VDE 0884 in 3 available lead forms :-
  - STD
  - G form
  - SMD approved to CECC 00802
- Certified to EN60950 by the following Test Bodies :-
  - Nemko - Certificate No. P96101299
  - Fimko - Registration No. 190469-01..22
  - Semko - Reference No. 9620076 01
  - Demko - Reference No. 305567

**DESCRIPTION**

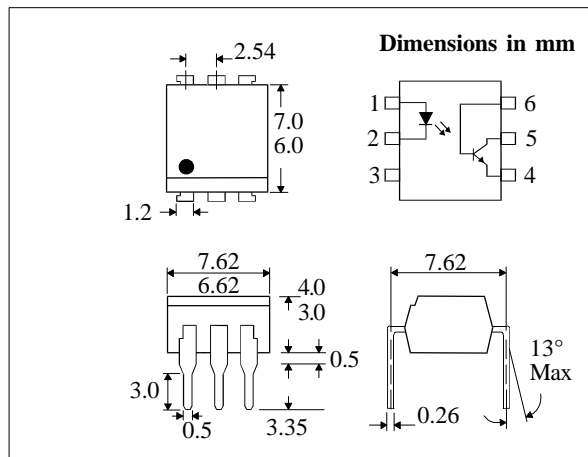
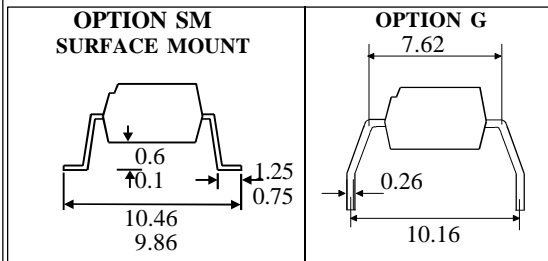
The H11A series of optically coupled isolators consist of infrared light emitting diode and NPN silicon photo transistor in a standard 6 pin dual in line plastic package.

**FEATURES**

- Options :-
  - 10mm lead spread - add G after part no.
  - Surface mount - add SM after part no.
  - Tape&reel - add SMT&R after part no.
- High Isolation Voltage (5.3kV<sub>RMS</sub>, 7.5kV<sub>PK</sub>)
- All electrical parameters 100% tested
- Custom electrical selections available

**APPLICATIONS**

- DC motor controllers
- Industrial systems controllers
- Measuring instruments
- Signal transmission between systems of different potentials and impedances



**ABSOLUTE MAXIMUM RATINGS  
 (25°C unless otherwise specified)**

Storage Temperature \_\_\_\_\_ -55°C to + 150°C  
 Operating Temperature \_\_\_\_\_ -55°C to + 100°C  
 Lead Soldering Temperature  
 (1/16 inch (1.6mm) from case for 10 secs) 260°C

**INPUT DIODE**

Forward Current \_\_\_\_\_ 60mA  
 Reverse Voltage \_\_\_\_\_ 6V  
 Power Dissipation \_\_\_\_\_ 105mW

**OUTPUT TRANSISTOR**

Collector-emitter Voltage  $BV_{CEO}$  \_\_\_\_\_ 30V  
 Collector-base Voltage  $BV_{CBO}$  \_\_\_\_\_ 70V  
 Emitter-collector Voltage  $BV_{ECO}$  \_\_\_\_\_ 6V  
 Power Dissipation \_\_\_\_\_ 160mW

**POWER DISSIPATION**

Total Power Dissipation \_\_\_\_\_ 200mW  
 (derate linearly 2.67mW/°C above 25°C)

**ISOCOMCOMPONENTSLTD**  
 Unit 25B, Park View Road West,  
 Park View Industrial Estate, Brenda Road  
 Hartlepool, TS25 1YD England Tel: (01429)863609  
 Fax: (01429) 863581 e-mail sales@isocom.co.uk  
<http://www.isocom.com>

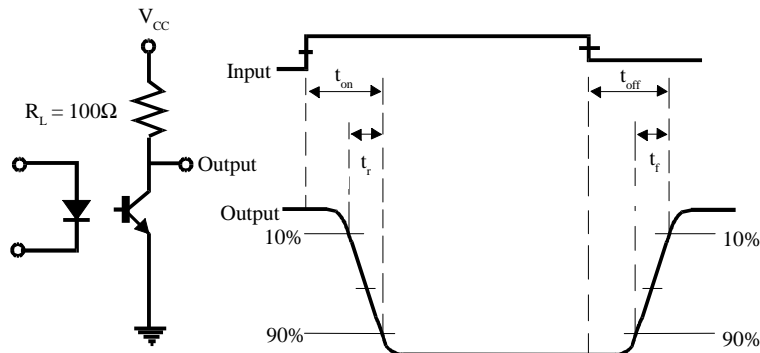
**ISOCOM INC**  
 1024 S. Greenville Ave., Suite 240,  
 Allen, TX 75002 USA  
 Tel: (214)495-0755 Fax: (214)495-0901  
 e-mail info@isocom.com  
<http://www.isocom.com>

**ELECTRICAL CHARACTERISTICS (  $T_A = 25^\circ\text{C}$  Unless otherwise noted )**

PARAMETER		MIN	TYP	MAX	UNITS	TEST CONDITION
Input	Forward Voltage ( $V_F$ )		1.2	1.5	V	$I_F = 10\text{mA}$
	Reverse Voltage ( $V_R$ )	6			V	$I_R = 10\mu\text{A}$
	Reverse Current ( $I_R$ )			10	$\mu\text{A}$	$V_R = 6\text{V}$
Output	Collector-emitter Breakdown ( $BV_{CEO}$ ) ( note 2 )	30			V	$I_C = 1\text{mA}$
	Collector-base Breakdown ( $BV_{CBO}$ )	70			V	$I_C = 100\mu\text{A}$
	Emitter-collector Breakdown ( $BV_{ECO}$ )	6			V	$I_E = 100\mu\text{A}$
	Collector-emitter Dark Current ( $I_{CEO}$ )			50	nA	$V_{CE} = 10\text{V}$
	Collector-base Dark Current ( $I_{CBO}$ )			20	nA	$V_{CE} = 10\text{V}$
Coupled	Current Transfer Ratio (CTR)					
	H11A1	50			%	$10\text{mA } I_F, 10\text{V } V_{CE}$
	H11A2	20			%	$10\text{mA } I_F, 10\text{V } V_{CE}$
	H11A3	20			%	$10\text{mA } I_F, 10\text{V } V_{CE}$
	H11A4	10			%	$10\text{mA } I_F, 10\text{V } V_{CE}$
	H11A5	30			%	$10\text{mA } I_F, 10\text{V } V_{CE}$
	Collector-emitter Saturation Voltage $V_{CE(SAT)}$			0.4	V	$10\text{mA } I_F, 0.5\text{mA } I_C$
	Input to Output Isolation Voltage $V_{ISO}$	5300			$V_{RMS}$	See note 1
		7500			$V_{PK}$	See note 1
	Input-output Isolation Resistance $R_{ISO}$	$5 \times 10^{10}$			$\Omega$	$V_{IO} = 500\text{V}$ (note 1)
Output Rise Time $t_r$		2		$\mu\text{s}$	$V_{CC} = 10\text{V}, I_C = 2\text{mA}$	
Output Fall Time $t_f$		2		$\mu\text{s}$	$R_L = 100\Omega$ fig 1	

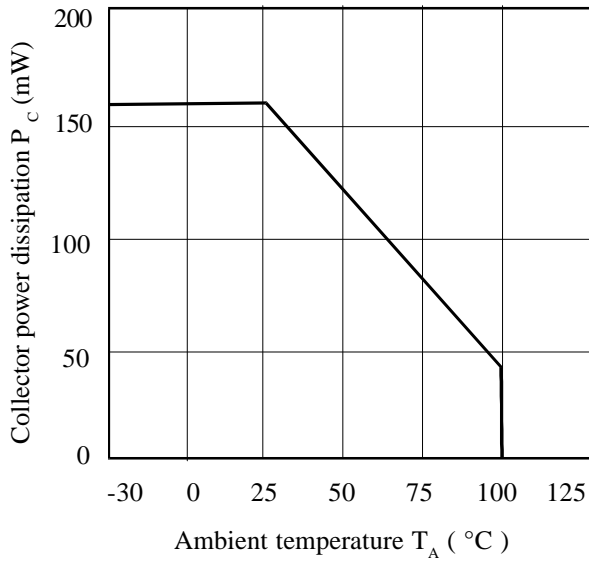
Note 1 Measured with input leads shorted together and output leads shorted together.

Note 2 Special Selections are available on request. Please consult the factory.

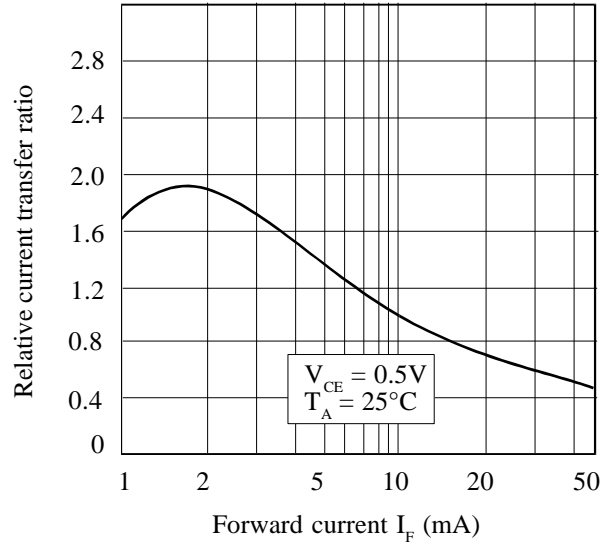


**FIG 1**

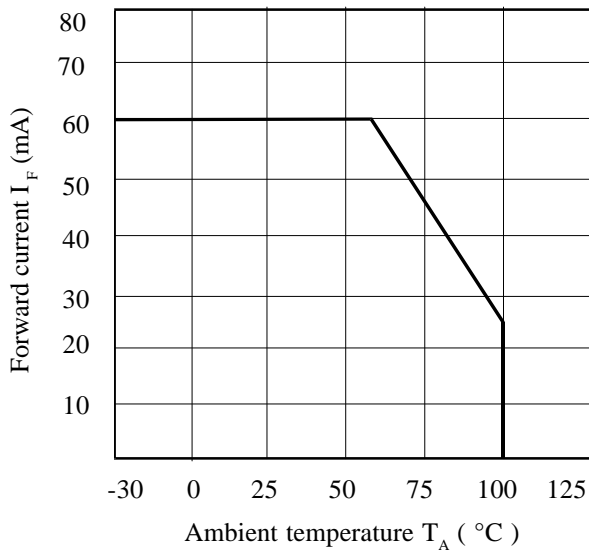
**Collector Power Dissipation vs. Ambient Temperature**



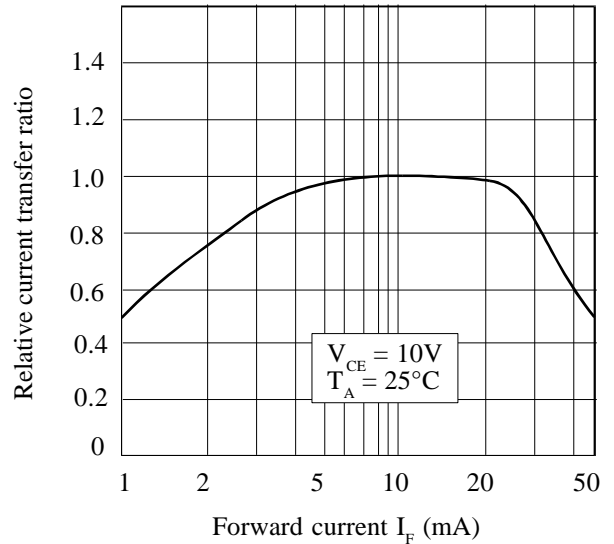
**Relative Current Transfer Ratio vs. Forward Current**



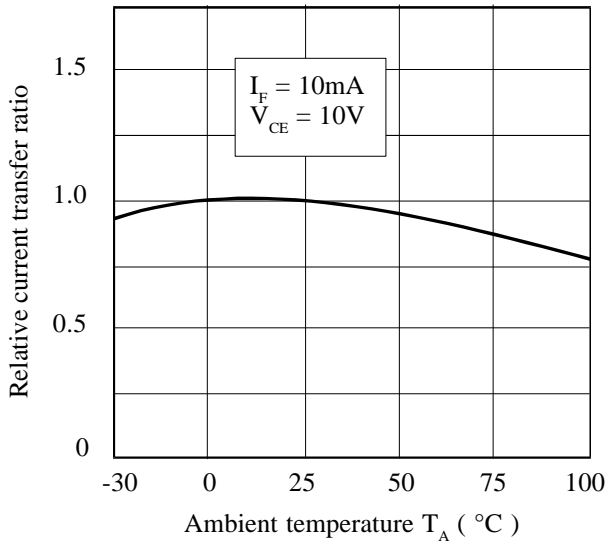
**Forward Current vs. Ambient Temperature**



**Relative Current Transfer Ratio vs. Forward Current**



**Relative Current Transfer Ratio vs. Ambient Temperature**



**Collector-emitter Saturation Voltage vs. Ambient Temperature**

