

Distributed by:



www.Jameco.com ♦ 1-800-831-4242

The content and copyrights of the attached material are the property of its owner.



Optocoupler, Phototransistor Output, With Base Connection

Features

- Interfaces with common logic families
- Input-output coupling capacitance < 0.5 pF
- Industry Standard Dual-in line 6-pin package
- 5300 V_{RMS} isolation test voltage

Agency Approvals

- UL File #E52744 System Code H or J
- CSA 93751
- BSI IEC60950 IEC60965
- DIN EN 60747-5-2(VDE0884)
DIN EN 60747-5-5 pending
Available with Option 1
- FIMKO

Applications

AC mains detection
 Reed relay driving
 Switch mode power supply feedback
 Telephone ring detection
 Logic ground isolation
 Logic coupling with high frequency noise rejection

Description

The H11Ax family is an Industry Standard Single Channel Phototransistor Coupler. It includes the H11A1/ H11A2/ H11A3/ H11A4/ H11A5 couplers.

Each optocoupler consists of gallium arsenide infrared LED and a silicon NPN phototransistor.

The isolation performance is accomplished through Vishay double molding isolation manufacturing process. Compliance to DIN EN 60747-5-2(VDE0884)/ DIN EN 60747-5-5 pending partial discharge isolation specification is available is by ordering option 1.

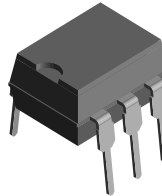

I179004

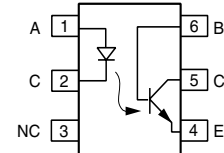

These isolation processes and the Vishay ISO9001 quality program results in the highest isolation performance available for a commercial plastic phototransistor optocoupler.

The devices are available in lead formed configuration suitable for surface mounting and are available either on tape and reel, or in standard tube shipping containers.

Footnotes

Designing with data sheet is covered in Application Note 45.

Order Information

Part	Remarks
H11A1	CTR > 50 %, DIP-6
H11A2	CTR > 20 %, DIP-6
H11A3	CTR > 20 %, DIP-6
H11A4	CTR > 10 %, DIP-6
H11A5	CTR > 30 %, DIP-6
H11A1-X006	CTR > 50 %, DIP-6 400 mil (option 6)
H11A1-X007	CTR > 50 %, SMD-6 (option 7)
H11A1-X009	CTR > 50 %, SMD-6 (option 9)

For additional information on the available options refer to Option Information.

Absolute Maximum Ratings

$T_{amb} = 25\text{ °C}$, unless otherwise specified

Stresses in excess of the absolute Maximum Ratings can cause permanent damage to the device. Functional operation of the device is not implied at these or any other conditions in excess of those given in the operational sections of this document. Exposure to absolute Maximum Rating for extended periods of the time can adversely affect reliability.

Input

Parameter	Test condition	Symbol	Value	Unit
Reverse voltage		V_R	6.0	V
Forward current		I_F	60	mA
Surge current	$t \leq 10\ \mu\text{s}$	I_{FSM}	2.5	A
Power dissipation		P_{diss}	100	mW

Output

Parameter	Test condition	Symbol	Value	Unit
Collector-emitter breakdown voltage		V_{CEO}	70	V
Emitter-base breakdown voltage		V_{EBO}	7.0	V
Collector current		I_C	50	mA
	$(t < 1.0\ \text{ms})$	I_C	100	mA
Power dissipation		P_{diss}	150	mW

Coupler

Parameter	Test condition	Symbol	Value	Unit
Isolation test voltage		V_{ISO}	5300	V_{RMS}
Creepage			≥ 7.0	mm
Clearance			≥ 7.0	mm
Isolation thickness between emitter and detector			≥ 0.4	mm
Comparative tracking index per DIN IEC 112/VDE0303, part 1			175	
Isolation resistance	$V_{IO} = 500\ \text{V}, T_{amb} = 25\text{ °C}$	R_{IO}	10^{12}	Ω
	$V_{IO} = 500\ \text{V}, T_{amb} = 100\text{ °C}$	R_{IO}	10^{11}	Ω
Storage temperature		T_{amb}	- 55 to + 150	$^{\circ}\text{C}$
Operating temperature		T_{stg}	- 55 to + 100	$^{\circ}\text{C}$
Junction temperature		T_j	100	$^{\circ}\text{C}$
Soldering temperature	max. 10 s dip soldering: distance to seating plane $\geq 1.5\ \text{mm}$	T_{sld}	260	$^{\circ}\text{C}$



Electrical Characteristics

$T_{amb} = 25\text{ }^{\circ}\text{C}$, unless otherwise specified

Minimum and maximum values are testing requirements. Typical values are characteristics of the device and are the result of engineering evaluation. Typical values are for information only and are not part of the testing requirements.

Input

Parameter	Test condition	Part	Symbol	Min	Typ.	Max	Unit
Forward voltage	$I_F = 10\text{ mA}$	H11A1	V_F		1.1	1.5	V
		H11A2	V_F		1.1	1.5	V
		H11A3	V_F		1.1	1.5	V
		H11A4	V_F		1.1	1.5	V
		H11A5	V_F		1.1	1.7	V
Reverse current	$V_R = 3.0\text{ V}$		I_R			10	μA
Capacitance	$V_R = 0, f = 1.0\text{ MHz}$		C_O		50		pF

Output

Parameter	Test condition	Symbol	Min	Typ.	Max	Unit
Collector-emitter breakdown voltage	$I_C = 1.0\text{ mA}, I_F = 0\text{ mA}$	BV_{CEO}	30			V
Emitter-collector breakdown voltage	$I_E = 100\text{ }\mu\text{A}, I_F = 0\text{ mA}$	BV_{ECO}	7.0			V
Collector-base breakdown voltage	$I_C = 10\text{ }\mu\text{A}, I_F = 0\text{ mA}$	BV_{CBO}	70			V
Collector-emitter leakage current	$V_{CE} = 10\text{ V}, I_F = 0\text{ mA}$	I_{CEO}		5.0	50	nA
Collector-emitter capacitance	$V_{CE} = 0$	C_{CE}		6.0		pF

Coupler

Parameter	Test condition	Symbol	Min	Typ.	Max	Unit
Saturation voltage, collector-emitter	$I_{CE} = 0.5\text{ mA}, I_F = 10\text{ mA}$	V_{CEsat}			0.4	V
Capacitance (input-output)		C_{IO}		0.5		pF

Current Transfer Ratio

Parameter	Test condition	Part	Symbol	Min	Typ.	Max	Unit
DC Current Transfer Ratio	$V_{CE} = 10\text{ V}, I_F = 10\text{ mA}$	H11A1	CTR_{DC}	50			%
		H11A2	CTR_{DC}	20			%
		H11A3	CTR_{DC}	20			%
		H11A4	CTR_{DC}	10			%
		H11A5	CTR_{DC}	30			%

Switching Characteristics

Parameter	Test condition	Symbol	Min	Typ.	Max	Unit
Switching time	$I_C = 2 \text{ mA}$, $R_L = 100 \Omega$, $V_{CE} = 10 \text{ V}$	t_{on} , t_{off}		3.0		μs

Typical Characteristics ($T_{amb} = 25 \text{ }^\circ\text{C}$ unless otherwise specified)

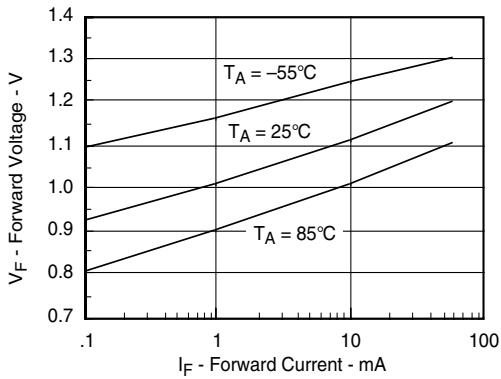

4m25_01

Fig. 1 Forward Voltage vs. Forward Current

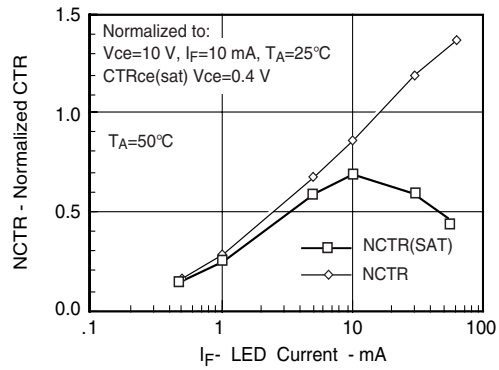

4m25_03

Fig. 3 Normalized Non-saturated and Saturated CTR vs. LED Current

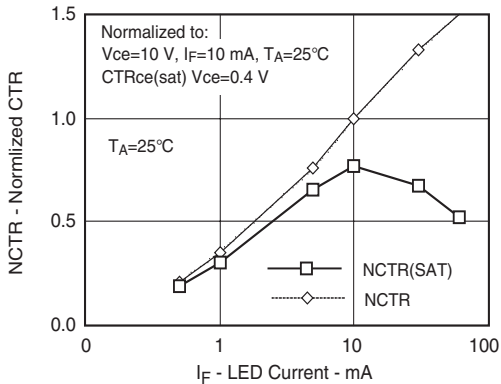

4m25_02

Fig. 2 Normalized Non-Saturated and Saturated CTR vs. LED Current

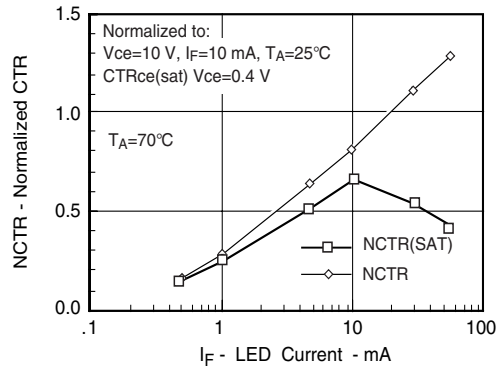

4m25_04

Fig. 4 Normalized Non-saturated and saturated CTR vs. LED Current

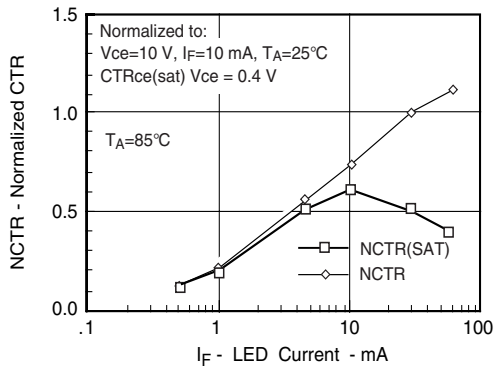

44n25_05

Fig. 5 Normalized Non-saturated and saturated CTR vs. LED Current

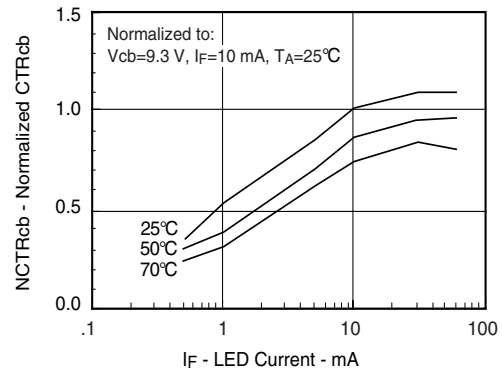

44n25_08

Fig. 8 Normalized CTRcb vs. LED Current and Temp.

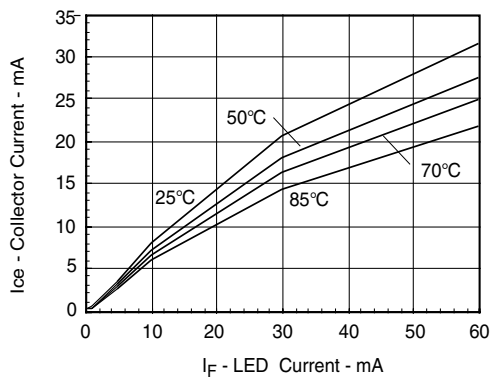

44n25_06

Fig. 6 Collector-Emitter Current vs. Temperature and LED Current

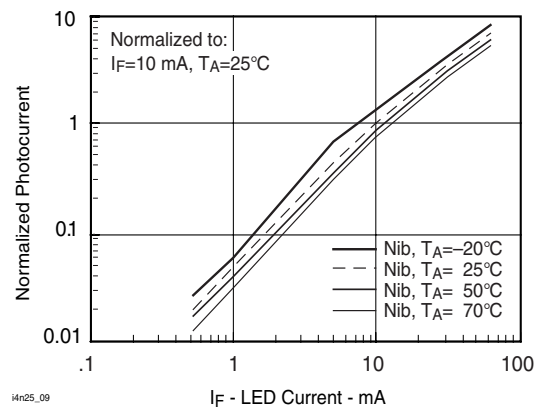

44n25_09

Fig. 9 Normalized Photocurrent vs. I_F and Temp.

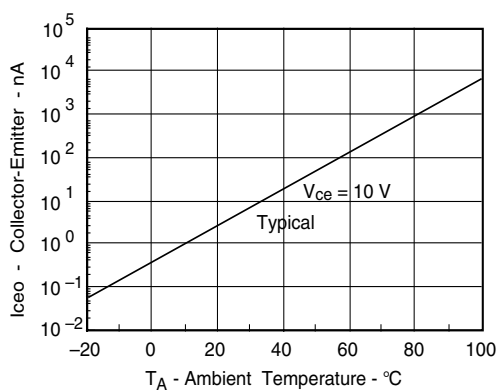

44n25_07

Fig. 7 Collector-Emitter Leakage Current vs. Temp.

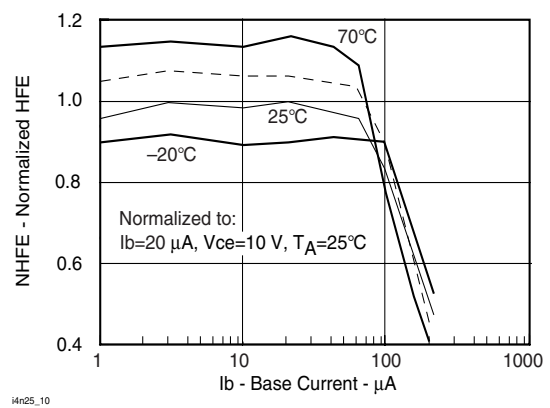

44n25_10

Fig. 10 Normalized Non-saturated HFE vs. Base Current and Temperature

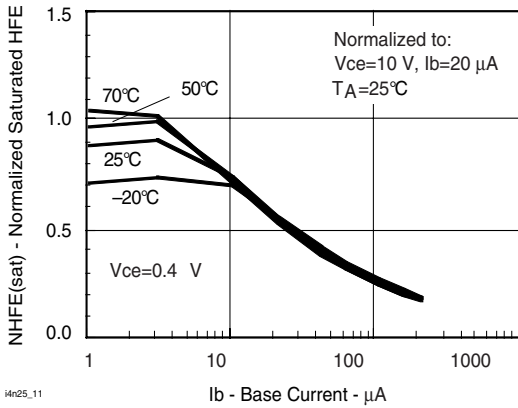

4n25_11

Fig. 11 Normalized HFE vs. Base Current and Temp.

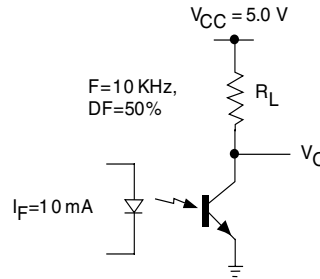

4n25_14

Fig. 14 Switching Schematic

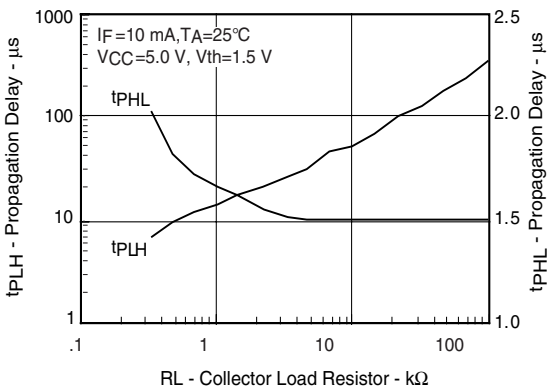

4n25_12

Fig. 12 Propagation Delay vs. Collector Load Resistor

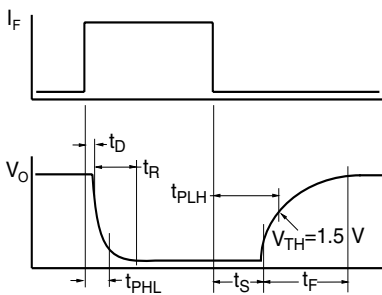

4n25_13

Fig. 13 Switching Timing



H11A1/ H11A2/ H11A3/ H11A4/ H11A5

Vishay Semiconductors

Package Dimensions in Inches (mm)

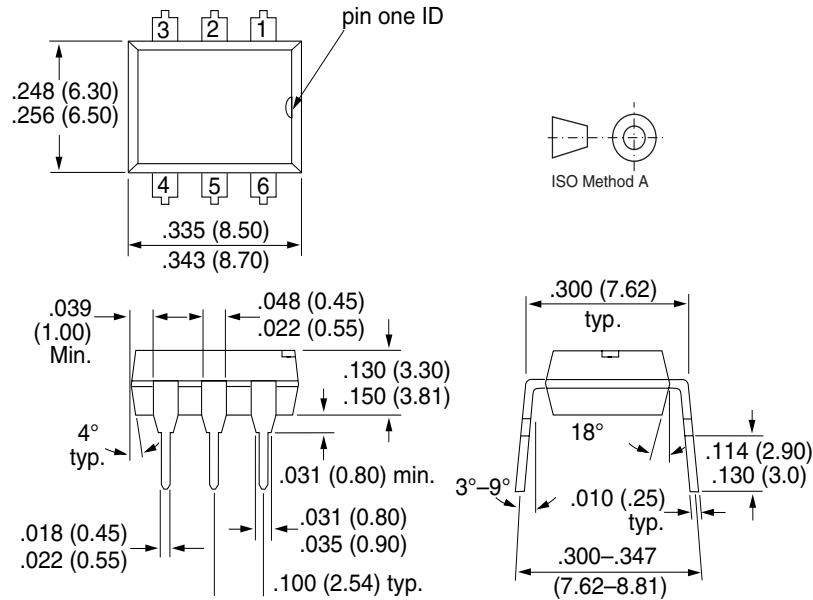

i178004

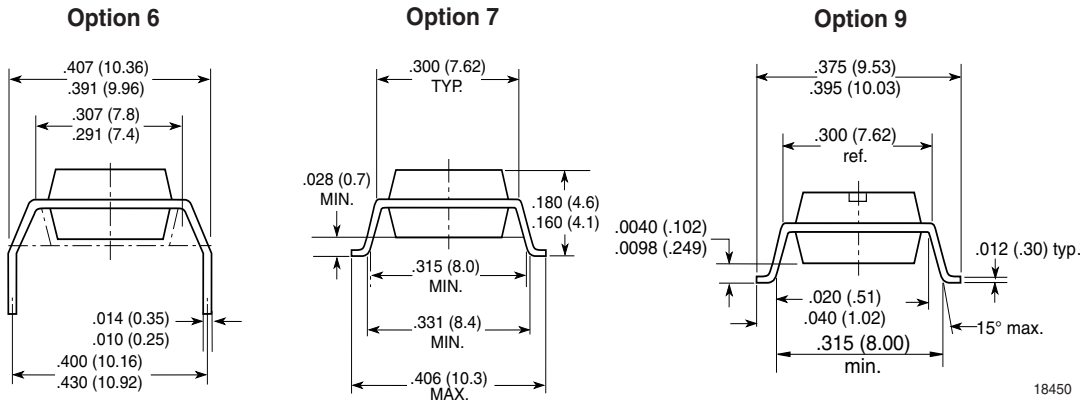

18450

Ozone Depleting Substances Policy Statement

It is the policy of **Vishay Semiconductor GmbH** to

1. Meet all present and future national and international statutory requirements.
2. Regularly and continuously improve the performance of our products, processes, distribution and operating systems with respect to their impact on the health and safety of our employees and the public, as well as their impact on the environment.

It is particular concern to control or eliminate releases of those substances into the atmosphere which are known as ozone depleting substances (ODSs).

The Montreal Protocol (1987) and its London Amendments (1990) intend to severely restrict the use of ODSs and forbid their use within the next ten years. Various national and international initiatives are pressing for an earlier ban on these substances.

Vishay Semiconductor GmbH has been able to use its policy of continuous improvements to eliminate the use of ODSs listed in the following documents.

1. Annex A, B and list of transitional substances of the Montreal Protocol and the London Amendments respectively
2. Class I and II ozone depleting substances in the Clean Air Act Amendments of 1990 by the Environmental Protection Agency (EPA) in the USA
3. Council Decision 88/540/EEC and 91/690/EEC Annex A, B and C (transitional substances) respectively.

Vishay Semiconductor GmbH can certify that our semiconductors are not manufactured with ozone depleting substances and do not contain such substances.

**We reserve the right to make changes to improve technical design
and may do so without further notice.**

Parameters can vary in different applications. All operating parameters must be validated for each customer application by the customer. Should the buyer use Vishay Semiconductors products for any unintended or unauthorized application, the buyer shall indemnify Vishay Semiconductors against all claims, costs, damages, and expenses, arising out of, directly or indirectly, any claim of personal damage, injury or death associated with such unintended or unauthorized use.

Vishay Semiconductor GmbH, P.O.B. 3535, D-74025 Heilbronn, Germany
Telephone: 49 (0)7131 67 2831, Fax number: 49 (0)7131 67 2423