

Distributed by:

**JAMECO**<sup>®</sup>  
ELECTRONICS

**www.Jameco.com ♦ 1-800-831-4242**

The content and copyrights of the attached  
material are the property of its owner.

Jameco Part Number 300600

Date	Rev.	Description

Size : 80 x 80 x 38  
Unit : mm

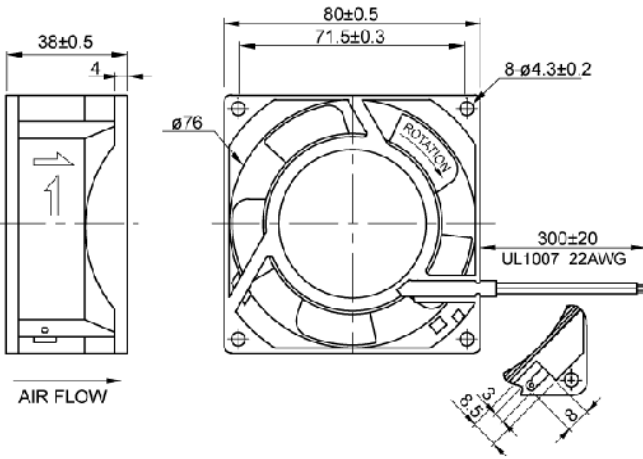
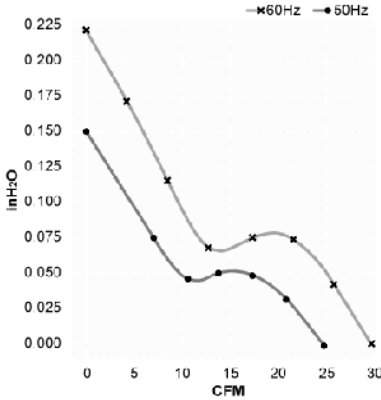

**Terminal or Lead Wire Type**

**Impedance Protection**

Spec. / Model	Rated Voltage V	Frequency Hz	Input Power W	Rated Current A	Locked Current A	Speed RPM	Maximum Air Flow m <sup>3</sup> /min.	Maximum Air Flow CFM	Maximum Pressure mmH <sub>2</sub> O	Maximum Pressure InchH <sub>2</sub> O	Noise dB	Weight kg
UF80A10-H	100V	50	14	0.14	0.15	2500	0.68	24	4.0	0.16	32	0.28
		60	12	0.12	0.14	3000	0.83	30	5.5	0.22	36	
UF80A11-H	115V	50	12	0.14	0.15	2500	0.68	24	4.0	0.16	32	0.28
		60	9	0.12	0.13	3000	0.83	30	5.5	0.22	36	
UF80A20-H	200V	50	14	0.07	0.08	2500	0.68	24	4.0	0.16	32	0.28
		60	12	0.06	0.07	3000	0.83	30	5.5	0.22	36	
UF80A23-H	230V	50	14	0.07	0.08	2500	0.68	24	4.0	0.16	32	0.28
		60	12	0.06	0.07	3000	0.83	30	5.5	0.22	36	
UF80A11-L	115V	50	12	0.12	0.13	1900	0.55	20	2.5	0.10	28	0.28
		60	9	0.10	0.11	2400	0.70	25	4.0	0.16	32	
UF80A23-L	230V	50	14	0.06	0.07	1900	0.55	20	2.5	0.10	28	0.28
		60	12	0.05	0.06	2400	0.70	25	4.0	0.16	32	

DCC. NO.  
A4 DRAWING NO.

MATERIAL		<b>GOLDSUN ELECTRONICS CO., LTD.</b>			
		JAMECO NO. <b>300600</b>		GOLDSUN NO. UF80A11-H	
DRWN	Kiki Chen	DATE	Description FAN		Rev. 1
CHK	Ada Zheng	DATE			
APVD	Chesley Chang	DATE	UNIT: mm	SCALE: SHEET 1 OF 1	CAS No: ERN No: