

TOSHIBA**4N35,4N36,4N37(Short)**

TOSHIBA PHOTOCOUPLER GaAs IRED & PHOTO-TRANSISTOR

4N35(Short), 4N36(Short), 4N37(Short)

AC LINE /DIGITAL LOGIC ISOLATOR.

DIGITAL LOGIC /DIGITAL LOGIC ISOLATOR.

TELEPHONE LINE RECEIVER.

TWISTED PAIR LINE RECEIVER.

HIGH FREQUENCY POWER SUPPLY FEEDBACK CONTROL.

RELAY CONTACT MONITOR.

The TOSHIBA 4N35 (Short) through 4N37 (Short) consists of a gallium arsenide infrared emitting diode coupled with a silicon phototransistor in a dual in-line package.

- Switching Speeds : $3\mu\text{s}$ (Typ.)
- DC Current Transfer Ratio : 100% (Min.)
- Isolation Resistance : $10^{11}\Omega$ (Min.)
- Isolation Voltage : 2500Vrms (Min.)
- UL Recognized : UL1577, File No. E67349

Unit in mm

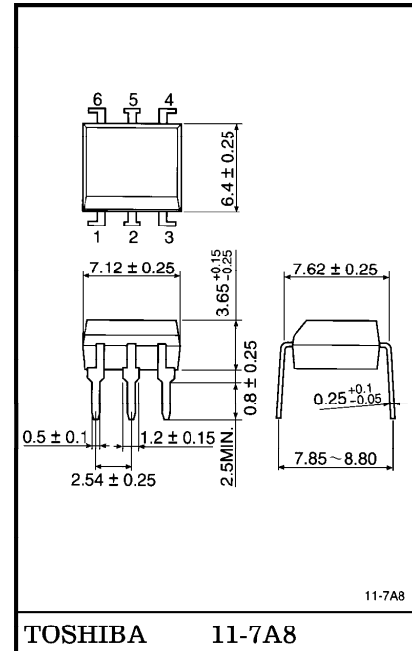

Weight : 0.4g

PIN CONFIGURATIONS (Top view)

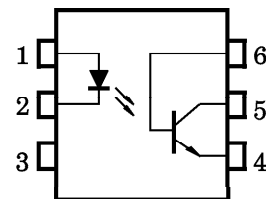

- 1 : ANODE
- 2 : CATHODE
- 3 : N.C.
- 4 : EMITTER
- 5 : COLLECTOR
- 6 : BASE

961001EBC2

- TOSHIBA is continually working to improve the quality and the reliability of its products. Nevertheless, semiconductor devices in general can malfunction or fail due to their inherent electrical sensitivity and vulnerability to physical stress. It is the responsibility of the buyer, when utilizing TOSHIBA products, to observe standards of safety, and to avoid situations in which a malfunction or failure of a TOSHIBA product could cause loss of human life, bodily injury or damage to property. In developing your designs, please ensure that TOSHIBA products are used within specified operating ranges as set forth in the most recent products specifications. Also, please keep in mind the precautions and conditions set forth in the TOSHIBA Semiconductor Reliability Handbook.
- Gallium arsenide (GaAs) is a substance used in the products described in this document. GaAs dust and fumes are toxic. Do not break, cut or pulverize the product, or use chemicals to dissolve them. When disposing of the products, follow the appropriate regulations. Do not dispose of the products with other industrial waste or with domestic garbage.
- The products described in this document are subject to foreign exchange and foreign trade control laws.
- The information contained herein is presented only as a guide for the applications of our products. No responsibility is assumed by TOSHIBA CORPORATION for any infringements of intellectual property or other rights of the third parties which may result from its use. No license is granted by implication or otherwise under any intellectual property or other rights of TOSHIBA CORPORATION or others.
- The information contained herein is subject to change without notice.

MAXIMUM RATINGS (Ta = 25°C)

CHARACTERISTIC		SYMBOL	RATING	UNIT	
LED	Forward Current (Continuous)	I_F	60	mA	
	Forward Current Derating	$\Delta I_F / ^\circ C$	0.8 (*)	mA / °C	
	Peak Forward Current (Note 1)	I_{PF}	3	A	
	Power Dissipation	P_D	100	mW	
	Power Dissipation Derating	$\Delta P_D / ^\circ C$	1.33 (*)	mW / °C	
	Reverse Voltage	V_R	6	V	
DETECTOR	Collector-Emitter Voltage	BV_{CEO}	30	V	
	Collector-Base Voltage	BV_{CBO}	70	V	
	Emitter-Collector Voltage	BV_{ECO}	7	V	
	Collector Current (Continuous)	I_C	100	mA	
	Power Dissipation	P_C	300	mW	
	Power Dissipation Derating	$\Delta P_C / ^\circ C$	4.0 (*)	mW / °C	
COUPLED	Storage Temperature	T_{stg}	-55~150	°C	
	Operating Temperature	T_{opr}	-55~100	°C	
	Lead Soldering Temperature (at 10s)	T_{sol}	260	°C	
	Total Package Power Dissipation	P_T	300	mW	
	Total Package Power Dissipation Derating	$\Delta P_T / ^\circ C$	3.3 (*)	mW / °C	
	Input to Output Isolation Voltage (AC, 1 Minute)		BV_S	2500	V_{rms}
		4N35	$BV_S (**)$	2500 / 3550	V_{rms} / V_{pk}
4N36		1750 / 2500			
4N37		1050 / 1500			

(Note 1) Pulse width 1μs, 300pps

(*) Above 25°C ambient.

(**) JEDEC registered maximum BV_S , however, TOSHIBA specifies a maximum BV_S of 2500 V_{rms} , 1 minute.

ELECTRICAL CHARACTERISTICS (Ta = 25°C)

CHARACTERISTIC		SYMBOL	TEST CONDITION	MIN.	TYP.	MAX.	UNIT	
LED	Forward Voltage	V _F	I _F = 10mA	0.8	1.15	1.5	V	
			I _F = 10mA, Ta = -55°C	0.9	—	1.7		
			I _F = 10mA, Ta = 100°C	0.7	—	1.4		
Reverse Current	I _R	V _R = 6V	—	—	10	μA		
Capacitance	C _D	V = 0, f = 1MHz	—	30	100	pF		
DETECTOR	DC Forward Current Gain	h _{FE}	V _{CE} = 5V, I _C = 500μA	—	200	—	—	
	Collector-Emitter Breakdown Voltage	V (BR) CEO	I _C = 10mA	30	—	—	V	
	Collector-Base Breakdown Voltage	V (BR) CBO	I _C = 100μA	70	—	—	V	
	Emitter-Collector Breakdown Voltage	V (BR) ECO	I _E = 100μA	7	—	—	V	
	Collector Dark Current	I _{CEO}	V _{CE} = 10V	—	1	50	nA	
	Collector Dark Current	I _{CEO}	V _{CE} = 30V, Ta = 100°C	—	—	500	μA	
	Collector-Emitter Capacitance	C _{CE}	V = 0, f = 1MHz	—	10	—	pF	
COUPLED	Current Transfer Ratio	I _C / I _F	I _F = 10mA, V _{CE} = 10V	100	—	—	%	
			I _F = 10mA, V _{CE} = 10V Ta = -55°C	40	—	—		
			I _F = 10mA, V _{CE} = 10V Ta = 100°C	40	—	—		
	Collector-Emitter Saturation Voltage	V _{CE (sat)}	I _F = 10mA, I _C = 0.5mA	—	0.1	0.3	V	
	Capacitance Input to Output	C _S	V _S = 0, f = 1MHz	—	0.8	2.5	pF	
	Isolation Resistance	R _S	V _S = 500V, R. H. ≤ 60%	10 ¹¹	—	—	Ω	
	Input to Output Isolation Current (Pulse Width = 8ms)	I _{IO}	4N35 4N36 4N37	V _{io} = 3550Vpk	—	—	100	μA
				V _{io} = 2500Vpk	—	—	100	
				V _{io} = 1500Vpk	—	—	100	
	Turn-On Time	t _{ON}	V _{CC} = 10V, I _C = 2mA	—	3	10	μs	
Turn-Off Time	t _{OFF}	R _L = 100Ω	—	3	10			

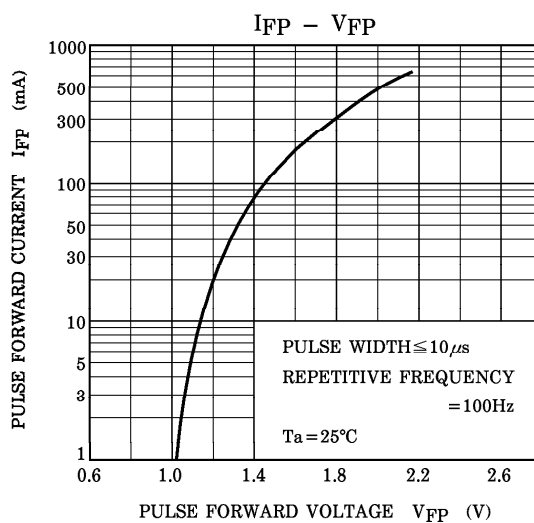
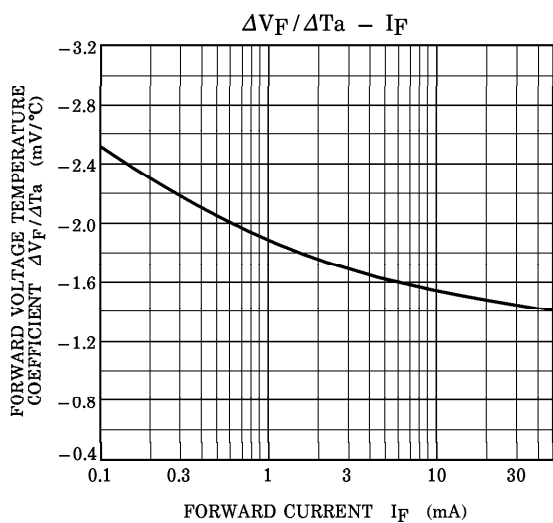
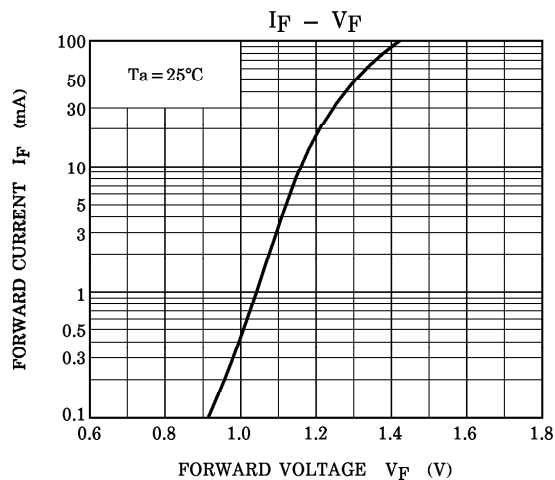
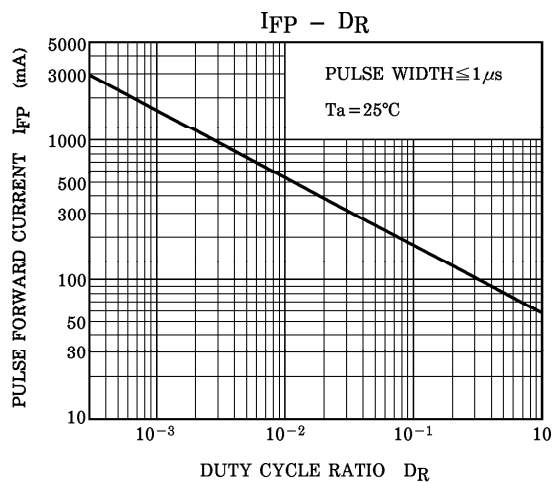
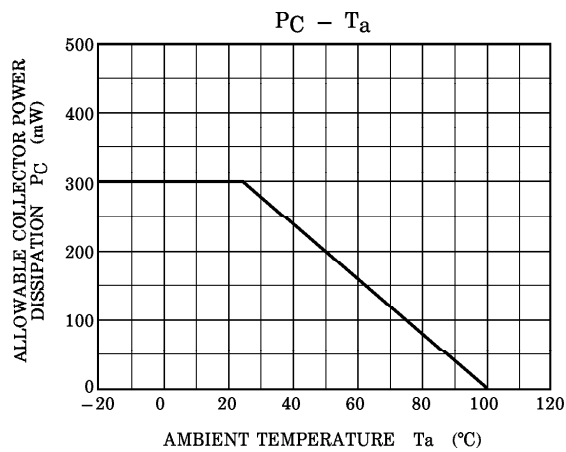
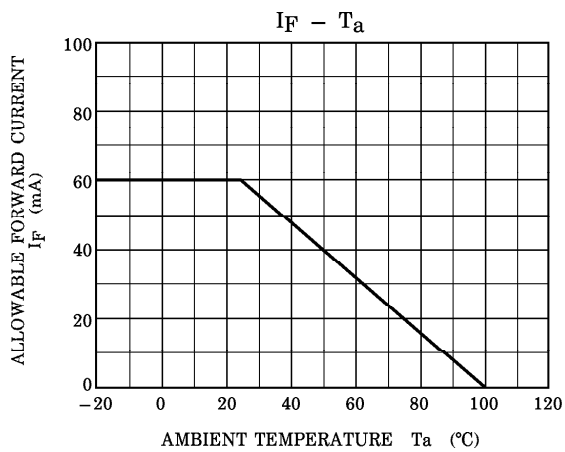

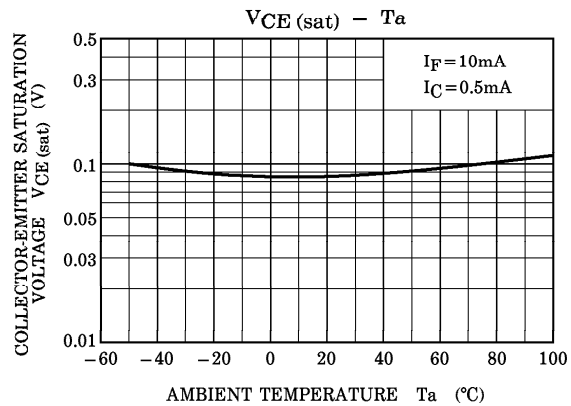
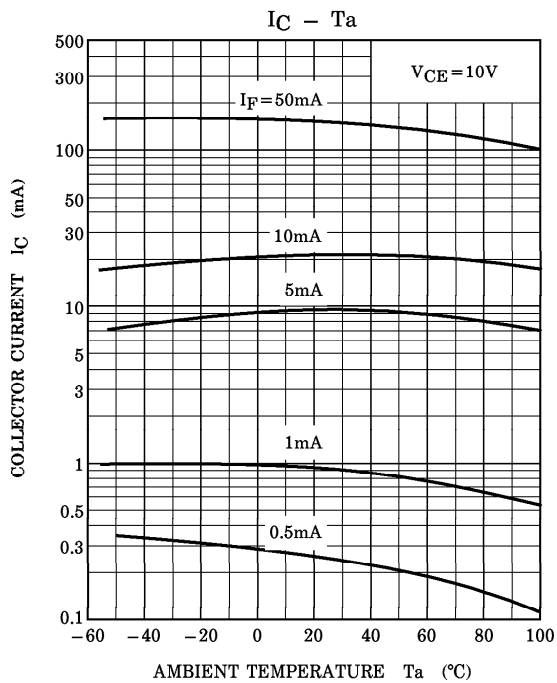
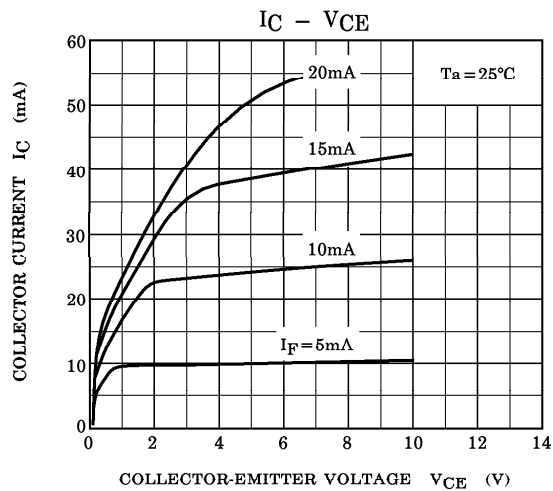
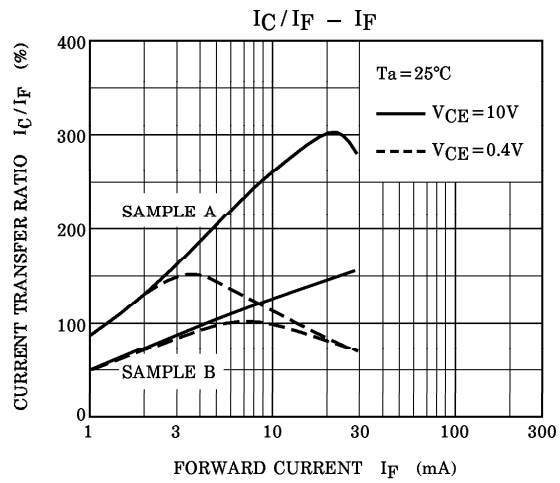
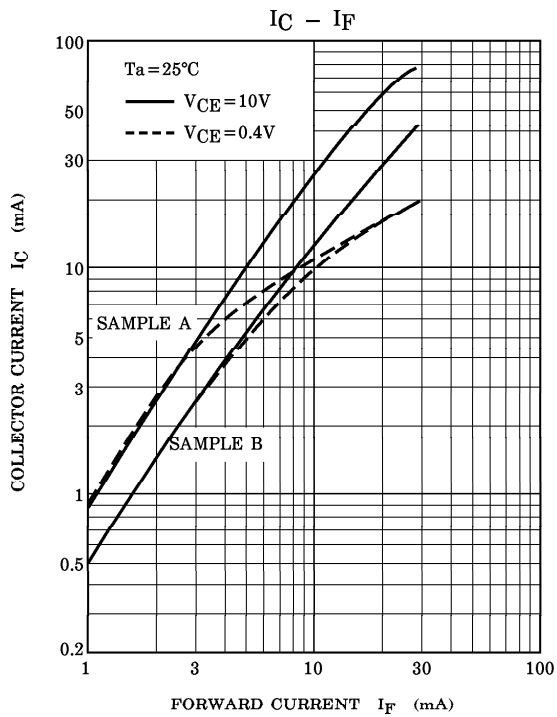

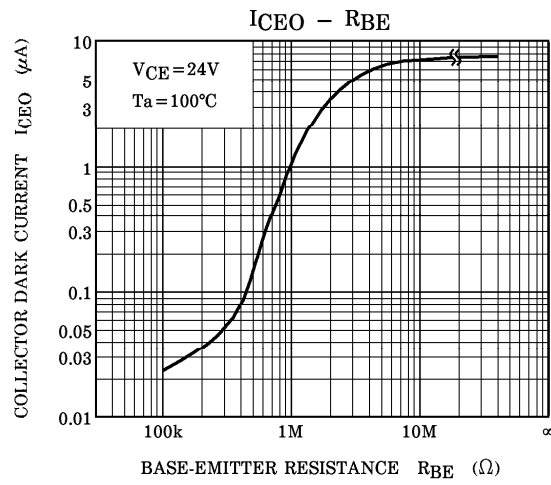
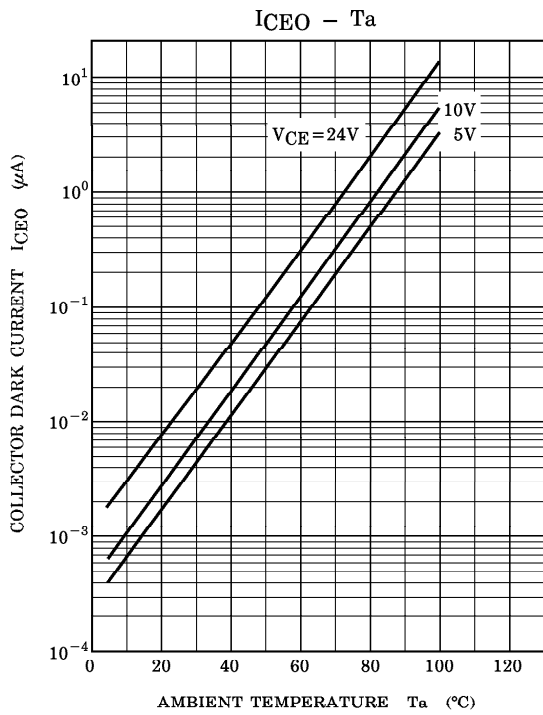

SWITCHING CHARACTERISTICS - RBE (SATURATED OPERATION)

