

Distributed by:

**JAMECO**<sup>®</sup>  
ELECTRONICS

**www.Jameco.com ♦ 1-800-831-4242**

The content and copyrights of the attached  
material are the property of its owner.

Jameco Part Number 40328

# 6100 Series

## IC Socket 2.54mm (0.100")

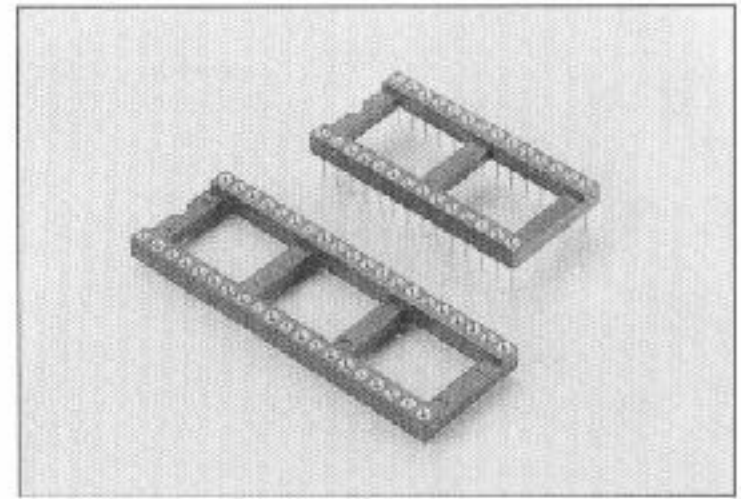
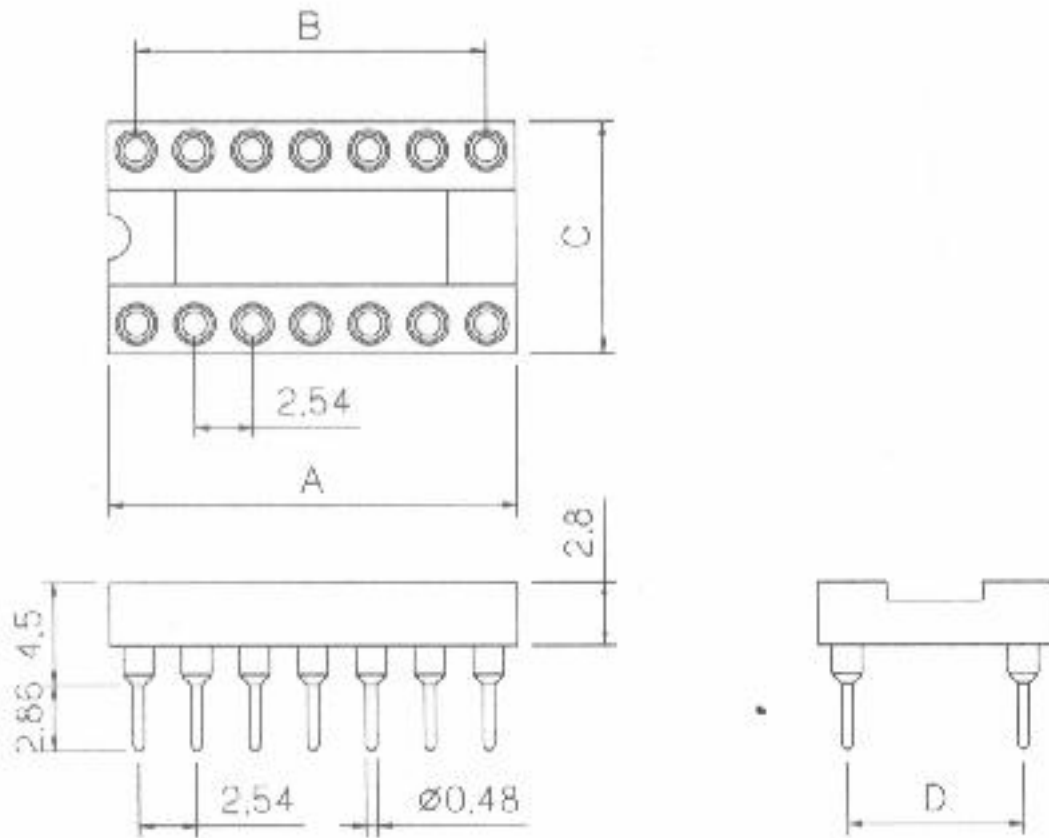

ROHS

### Dimensions

Positions	A	B	C	D
6	7.62	5.08	10.16	7.62
8	10.16	7.62	10.16	
14	17.78	15.24	10.16	
16	20.32	17.78	10.16	
18	22.86	20.32	10.16	
20	25.40	22.86	10.16	
24	30.48	27.94	10.16	
28	35.56	33.02	10.16	

### Dimensions

Positions	A	B	C	D
24	30.48	27.94	17.78	15.24
28	35.56	33.02	17.78	
32	40.64	38.10	17.78	
40	50.80	48.26	17.78	

## Product Specification

### Material

**Insulator:** Glass-Filled Thermoplastic  
UL 94V-0 rates, Color-Black

**Contact:** Brass or Phosphor Bronze  
Plated full gold or selected gold in mating area, 100u" min. tin-lead on termination area, with entire contact under-plated 50u" min. Nickel

### Electrical

**Contact Resistance:** 30 miliohms  
Max at 1 AMP DC.

**Insulation Resistance:** 1000  
megohms at 500 VDC

**Dielectric Withstanding Voltage:**  
500 VAC/rms 60Hz for 1 minute

**Current Rating:** 1 AMP

**Volatge Rating:** 250 VAC/rms  
60Hz

## Ordering Information

