

Distributed by:

**JAMECO**<sup>®</sup>  
ELECTRONICS

**www.Jameco.com ♦ 1-800-831-4242**

The content and copyrights of the attached  
material are the property of its owner.

Jameco Part Number 45305FSC

## MM74HC125/MM74HC126 3-STATE Quad Buffers

### General Description

The MM74HC125 and MM74HC126 are general purpose 3-STATE high speed non-inverting buffers utilizing advanced silicon-gate CMOS technology. They have high drive current outputs which enable high speed operation even when driving large bus capacitances. These circuits possess the low power dissipation of CMOS circuitry, yet have speeds comparable to low power Schottky TTL circuits. Both circuits are capable of driving up to 15 low power Schottky inputs.

The MM74HC125 require the 3-STATE control input C to be taken high to put the output into the high impedance

condition, whereas the MM74HC126 require the control input to be low to put the output into high impedance.

All inputs are protected from damage due to static discharge by diodes to  $V_{CC}$  and ground.

### Features

- Typical propagation delay: 13 ns
- Wide operating voltage range: 2–6V
- Low input current: 1  $\mu$ A maximum
- Low quiescent current: 80  $\mu$ A maximum (74HC)
- Fanout of 15 LS-TTL loads

### Ordering Code:

Order Number	Package Number	Package Description
MM74HC125M	M14A	14-Lead Small Outline Integrated Circuit (SOIC), JEDEC MS-120, 0.150" Narrow Body
MM74HC125SJ	M14D	14-Lead Small Outline Package (SOP), EIAJ TYPE II, 5.3mm Wide
MM74HC125MTC	MTC14	14-Lead Thin Shrink Small Outline Package (TSSOP), JEDEC MO-153, 4.4mm Wide
MM74HC125N	N14A	14-Lead Plastic Dual-In-Line Package (PDIP), JEDEC MS-001, 0.300" Wide
MM74HC126M	M14A	14-Lead Small Outline Integrated Circuit (SOIC), JEDEC MS-120, 0.150" Narrow Body
MM74HC126SJ	M14D	14-Lead Small Outline Package (SOP), EIAJ TYPE II, 5.3mm Wide
MM74HC126MTC	MTC14	14-Lead Thin Shrink Small Outline Package (TSSOP), JEDEC MO-153, 4.4mm Wide
MM74HC126N	N14A	14-Lead Plastic Dual-In-Line Package (PDIP), JEDEC MS-001, 0.300" Wide

Devices also available in Tape and Reel. Specify by appending the suffix letter "X" to the ordering code. (Tape and Reel not available in N14A.)

### Connection Diagrams

Pin Assignments for DIP, SOIC, SOP and TSSOP

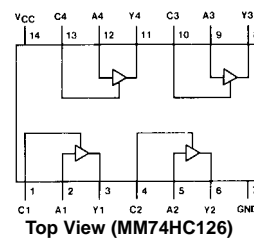
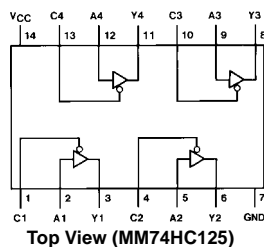

### Truth Tables

Inputs		Output
A	C	Y
H	L	H
L	L	L
X	H	Z

Inputs		Output
A	C	Y
H	H	H
L	H	L
X	L	Z

**Absolute Maximum Ratings** (Note 1)

(Note 2)

Supply Voltage ( $V_{CC}$ )	-0.5 to +7.0V
DC Input Voltage ( $V_{IN}$ )	-1.5 to $V_{CC} + 1.5V$
DC Output Voltage ( $V_{OUT}$ )	-0.5 to $V_{CC} + 0.5V$
Clamp Diode Current ( $I_{IK}, I_{OK}$ )	$\pm 20$ mA
DC Output Current, per pin ( $I_{OUT}$ )	$\pm 35$ mA
DC $V_{CC}$ or GND Current, per pin ( $I_{CC}$ )	$\pm 70$ mA
Storage Temperature Range ( $T_{STG}$ )	-65°C to +150°C
Power Dissipation ( $P_D$ )	
(Note 3)	600 mW
S.O. Package only	500 mW
Lead Temperature ( $T_L$ )	
(Soldering 10 seconds)	260°C

**Recommended Operating Conditions**

	Min	Max	Units
Supply Voltage ( $V_{CC}$ )	2	6	V
DC Input or Output Voltage ( $V_{IN}, V_{OUT}$ )	0	$V_{CC}$	V
Operating Temperature Range ( $T_A$ )	-40	+85	°C
Input Rise or Fall Times ( $t_r, t_f$ )			
$V_{CC} = 2.0V$		1000	ns
$V_{CC} = 4.5V$		500	ns
$V_{CC} = 6.0V$		400	ns

**Note 1:** Absolute Maximum Ratings are those values beyond which damage to the device may occur.

**Note 2:** Unless otherwise specified all voltages are referenced to ground.

**Note 3:** Power Dissipation temperature derating — plastic "N" package: -12 mW/°C from 65°C to 85°C.

**DC Electrical Characteristics** (Note 4)

Symbol	Parameter	Conditions	$V_{CC}$	$T_A = 25^\circ\text{C}$			Units	
				Typ	Guaranteed Limits			
$V_{IH}$	Minimum HIGH Level Input Voltage		2.0V		1.5	1.5	V	
			4.5V		3.15	3.15	V	
			6.0V		4.2	4.2	V	
$V_{IL}$	Maximum LOW Level Input Voltage		2.0V		0.5	0.5	V	
			4.5V		1.35	1.35	V	
			6.0V		1.8	1.8	V	
$V_{OH}$	Minimum HIGH Level Output Voltage	$V_{IN} = V_{IH}$ or $V_{IL}$ $ I_{OUT}  \leq 20 \mu\text{A}$	2.0V	2.0	1.9	1.9	V	
			4.5V	4.5	4.4	4.4	V	
			6.0V	6.0	5.9	5.9	V	
		$V_{IN} = V_{IH}$ or $V_{IL}$ $ I_{OUT}  \leq 6.0 \text{ mA}$ $ I_{OUT}  \leq 7.8 \text{ mA}$	4.5V	4.2	3.98	3.84	V	
			6.0V	5.7	5.48	5.34	V	
			6.0V				V	
$V_{OL}$	Maximum LOW Level Output Voltage	$V_{IN} = V_{IH}$ or $V_{IL}$ $ I_{OUT}  \leq 20 \mu\text{A}$	2.0V	0	0.1	0.1	V	
			4.5V	0	0.1	0.1	V	
			6.0V	0	0.1	0.1	V	
		$V_{IN} = V_{IH}$ or $V_{IL}$ $ I_{OUT}  \leq 6.0 \text{ mA}$ $ I_{OUT}  \leq 7.8 \text{ mA}$	4.5V	0.2	0.26	0.33	V	
			6.0V	0.2	0.26	0.33	V	
			6.0V				V	
$I_{OZ}$	Maximum 3-STATE Output Leakage Current	$V_{IN} = V_{IH}$ or $V_{IL}$ $V_{OUT} = V_{CC}$ or GND $C_n = \text{Disabled}$	6.0V		$\pm 0.5$	$\pm 5$	$\pm 10$	$\mu\text{A}$
$I_{IN}$	Maximum Input Current	$V_{IN} = V_{CC}$ or GND	6.0V		$\pm 0.1$	$\pm 1.0$	$\pm 1.0$	$\mu\text{A}$
$I_{CC}$	Maximum Quiescent Supply Current	$V_{IN} = V_{CC}$ or GND $I_{OUT} = 0 \mu\text{A}$	6.0V		8.0	80	160	$\mu\text{A}$

**Note 4:** For a power supply of  $5V \pm 10\%$  the worst case output voltages ( $V_{OH}$ , and  $V_{OL}$ ) occur for HC at 4.5V. Thus the 4.5V values should be used when designing with this supply. Worst case  $V_{IH}$  and  $V_{IL}$  occur at  $V_{CC} = 5.5V$  and 4.5V respectively. (The  $V_{IH}$  value at 5.5V is 3.85V.) The worst case leakage current ( $I_{IN}$ ,  $I_{CC}$ , and  $I_{OZ}$ ) occur for CMOS at the higher voltage and so the 6.0V values should be used.

AC Electrical Characteristics								
$V_{CC} = 5V, T_A = 25^\circ C, C_L = 45 \text{ pF}, t_r = t_f = 6 \text{ ns}$								
Symbol	Parameter	Conditions	Typ	Guaranteed Limit	Units			
$t_{PHL}, t_{PLH}$	Maximum Propagation Delay Time		13	18	ns			
$t_{PZH}$	Maximum Output Enable Time to HIGH Level	$R_L = 1 \text{ k}\Omega$	13	25	ns			
$t_{PHZ}$	Maximum Output Disable Time from HIGH Level	$R_L = 1 \text{ k}\Omega$ $C_L = 5 \text{ pF}$	17	25	ns			
$t_{PZL}$	Maximum Output Enable Time to LOW Level	$R_L = 1 \text{ k}\Omega$	18	25	ns			
$t_{PLZ}$	Maximum Output Disable Time from LOW Level	$R_L = 1 \text{ k}\Omega$ $C_L = 5 \text{ pF}$	13	25	ns			
AC Electrical Characteristics								
$V_{CC} = 2.0V \text{ to } 6.0V, C_L = 50 \text{ pF}, t_r = t_f = 6 \text{ ns}$ (unless otherwise specified)								
Symbol	Parameter	Conditions	$V_{CC}$	$T_A = 25^\circ C$		$T_A = -40 \text{ to } 85^\circ C$	$T_A = -40 \text{ to } 125^\circ C$	Units
				Typ	Guaranteed Limits			
$t_{PHL}, t_{PLH}$	Maximum Propagation Delay Time		2.0V	40	100	125	150	ns
			4.5V	14	20	25	30	ns
			6.0V	12	17	21	25	ns
$t_{PLH}, t_{PHL}$	Maximum Propagation Delay Time	$C_L = 150 \text{ pF}$	2.0V	35	130	163	195	ns
			4.5V	14	26	33	39	ns
			6.0V	12	22	28	39	ns
$t_{PZH}, t_{PZL}$	Maximum Output Enable Time	$R_L = 1 \text{ k}\Omega$	2.0V	25	125	156	188	ns
			4.5V	14	25	31	38	ns
			6.0V	12	21	26	31	ns
$t_{PHZ}, t_{PLZ}$	Maximum Output Disable Time	$R_L = 1 \text{ k}\Omega$	2.0V	25	125	156	188	ns
			4.5V	14	25	31	38	ns
			6.0V	12	21	26	31	ns
$t_{PZL}, t_{PZH}$	Maximum Output Enable Time	$C_L = 150 \text{ pF}$ $R_L = 1 \text{ k}\Omega$	2.0V	35	140	175	210	ns
			4.5V	15	28	35	42	ns
			6.0V	13	24	30	36	ns
$t_{TLH}, t_{THL}$	Maximum Output Rise and Fall Time	$C_L = 50 \text{ pF}$	2.0V	30	60	75	90	ns
			4.5V	7	12	15	18	ns
			6.0V	6	10	13	15	ns
$C_{IN}$	Input Capacitance			5	10	10	10	pF
$C_{OUT}$	Output Capacitance Outputs			15	20	20	20	pF
$C_{PD}$	Power Dissipation Capacitance (Note 5)	(per gate)						
		Enabled		45				pF
		Disabled		6				pF
<p><b>Note 5:</b> <math>C_{PD}</math> determines the no load dynamic power consumption, <math>P_D = C_{PD} V_{CC}^2 f + I_{CC} V_{CC}</math>, and the no load dynamic current consumption, <math>I_S = C_{PD} V_{CC} f + I_{CC}</math>.</p>								

**Physical Dimensions** inches (millimeters) unless otherwise noted

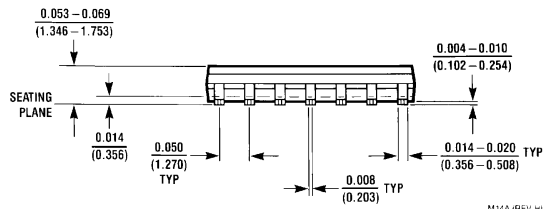
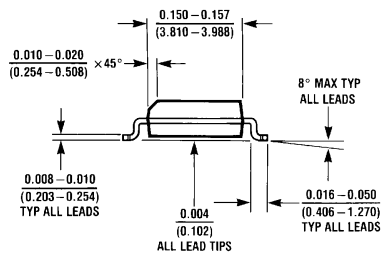
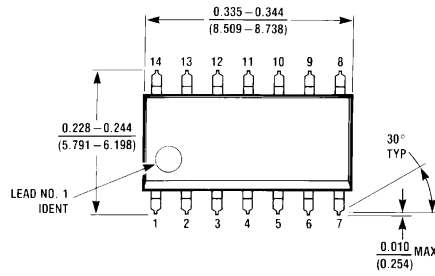

M14A (REV HI)

**14-Lead Small Outline Integrated Circuit (SOIC), JEDEC MS-120, 0.150" Narrow Body  
Package Number M14A**

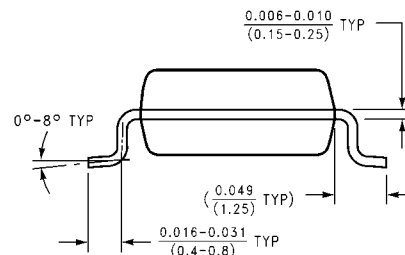
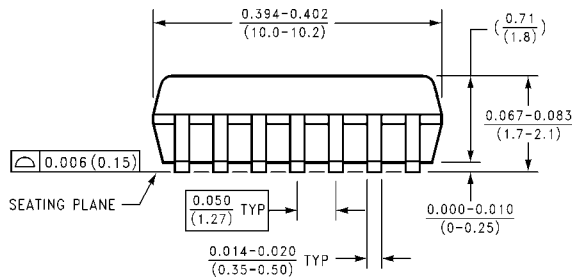
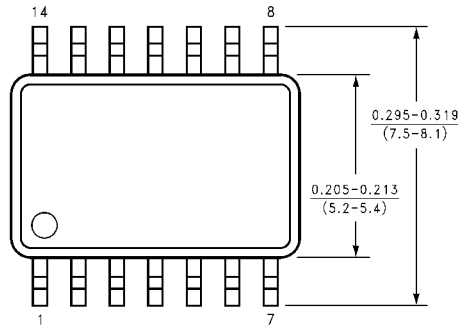

M14D (REV B)

**14-Lead Small Outline Package (SOP), EIAJ TYPE II, 5.3mm Wide  
Package Number M14D**

**Physical Dimensions** inches (millimeters) unless otherwise noted (Continued)

14LD, TSSOP, JEDEC MO-153, 4.4MM WIDE

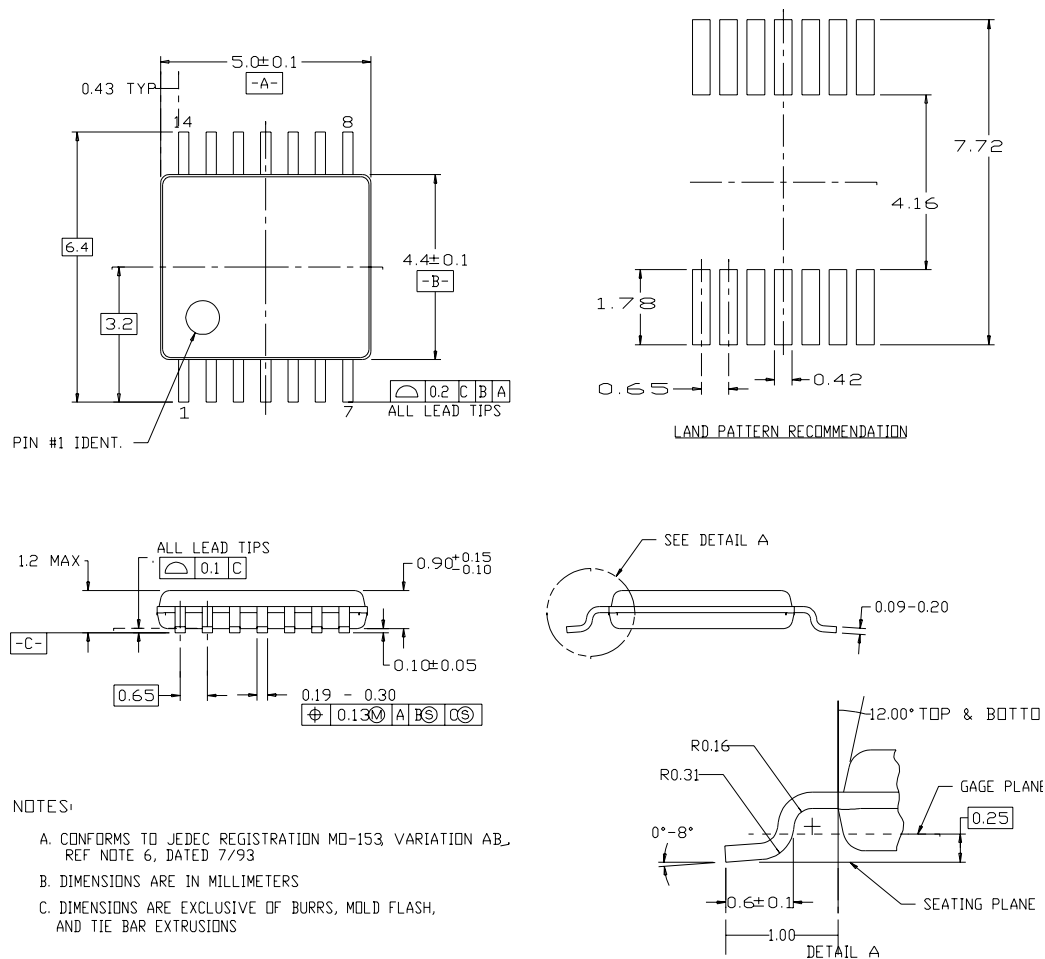

NOTES:

- A. CONFORMS TO JEDEC REGISTRATION MO-153, VARIATION AB, REF NOTE 6, DATED 7/93
- B. DIMENSIONS ARE IN MILLIMETERS
- C. DIMENSIONS ARE EXCLUSIVE OF BURRS, MOLD FLASH, AND TIE BAR EXTRUSIONS

**14-Thin Shrink Small Outline Package (TSSOP), JEDEC MO-153, 4.4mm Wide  
Package Number MTC14**

**Physical Dimensions** inches (millimeters) unless otherwise noted (Continued)

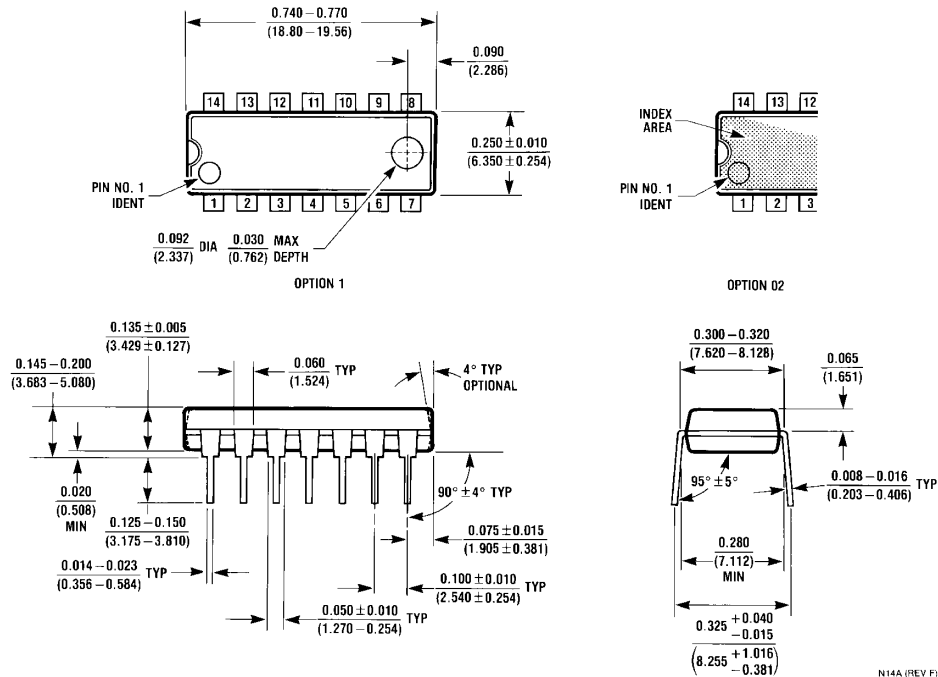

N14A (REV F)

**LIFE SUPPORT POLICY**

FAIRCHILD'S PRODUCTS ARE NOT AUTHORIZED FOR USE AS CRITICAL COMPONENTS IN LIFE SUPPORT DEVICES OR SYSTEMS WITHOUT THE EXPRESS WRITTEN APPROVAL OF THE PRESIDENT OF FAIRCHILD SEMICONDUCTOR CORPORATION. As used herein:

1. Life support devices or systems are devices or systems which, (a) are intended for surgical implant into the body, or (b) support or sustain life, and (c) whose failure to perform when properly used in accordance with instructions for use provided in the labeling, can be reasonably expected to result in a significant injury to the user.
2. A critical component in any component of a life support device or system whose failure to perform can be reasonably expected to cause the failure of the life support device or system, or to affect its safety or effectiveness.

[www.fairchildsemi.com](http://www.fairchildsemi.com)