

### Features

- 'HC161, 'HCT161 4-Bit Binary Counter, Asynchronous Reset
- 'HC163, 'HCT163 4-Bit Binary Counter, Synchronous Reset
- Synchronous Counting and Loading
- Two Count Enable Inputs for n-Bit Cascading
- Look-Ahead Carry for High-Speed Counting
- Fanout (Over Temperature Range)
  - Standard Outputs . . . . . 10 LSTTL Loads
  - Bus Driver Outputs . . . . . 15 LSTTL Loads
- Wide Operating Temperature Range . . . -55°C to 125°C
- Balanced Propagation Delay and Transition Times
- Significant Power Reduction Compared to LSTTL Logic ICs
- HC Types
  - 2V to 6V Operation
  - High Noise Immunity:  $N_{IL} = 30\%$ ,  $N_{IH} = 30\%$  of  $V_{CC}$  at  $V_{CC} = 5V$
- HCT Types
  - 4.5V to 5.5V Operation
  - Direct LSTTL Input Logic Compatibility,  $V_{IL} = 0.8V$  (Max),  $V_{IH} = 2V$  (Min)
  - CMOS Input Compatibility,  $I_I \leq 1\mu A$  at  $V_{OL}$ ,  $V_{OH}$

### Description

The 'HC161, 'HCT161, 'HC163, and 'HCT163 are presettable synchronous counters that feature look-ahead carry logic for use in high-speed counting applications. The 'HC161 and 'HCT161 are asynchronous reset decade and binary counters, respectively; the 'HC163 and 'HCT163 devices are decade and binary counters, respectively, that are reset synchronously with the clock. Counting and parallel presetting are both accomplished synchronously with the negative-to-positive transition of the clock.

A low level on the synchronous parallel enable input, SPE, disables counting operation and allows data at the P0 to P3 inputs to be loaded into the counter (provided that the setup and hold requirements for SPE are met).

All counters are reset with a low level on the Master Reset input, MR. In the 'HC163 and 'HCT163 counters (synchronous reset types), the requirements for setup and hold time with respect to the clock must be met.

Two count enables, PE and TE, in each counter are provided for n-bit cascading. In all counters reset action occurs regardless of the level of the  $\overline{SPE}$ , PE and TE inputs (and the clock input, CP, in the 'HC161 and 'HCT161 types).

If a decade counter is preset to an illegal state or assumes an illegal state when power is applied, it will return to the normal sequence in one count as shown in state diagram.

The look-ahead carry feature simplifies serial cascading of the counters. Both count enable inputs (PE and TE) must be high to count. The TE input is gated with the Q outputs of all four stages so that at the maximum count the terminal count (TC) output goes high for one clock period. This TC pulse is used to enable the next cascaded stage.

### Ordering Information

PART NUMBER	TEMP. RANGE (°C)	PACKAGE
CD54HC161F3A	-55 to 125	16 Ld CERDIP
CD54HC163F3A	-55 to 125	16 Ld CERDIP
CD54HCT163F3A	-55 to 125	16 Ld CERDIP
CD74HC161E	-55 to 125	16 Ld PDIP
CD74HC161M	-55 to 125	16 Ld SOIC
CD74HC161MT	-55 to 125	16 Ld SOIC
CD74HC161M96	-55 to 125	16 Ld SOIC
CD74HC163E	-55 to 125	16 Ld PDIP
CD74HC163M	-55 to 125	16 Ld SOIC
CD74HC163MT	-55 to 125	16 Ld SOIC
CD74HC163M96	-55 to 125	16 Ld SOIC
CD74HCT161E	-55 to 125	16 Ld PDIP
CD74HCT161M	-55 to 125	16 Ld SOIC
CD74HCT161MT	-55 to 125	16 Ld SOIC
CD74HCT161M96	-55 to 125	16 Ld SOIC
CD74HCT163E	-55 to 125	16 Ld PDIP
CD74HCT163M	-55 to 125	16 Ld SOIC
CD74HCT163MT	-55 to 125	16 Ld SOIC
CD74HCT163M96	-55 to 125	16 Ld SOIC

NOTE: When ordering, use the entire part number. The suffix 96 denotes tape and reel. The suffix T denotes a small-quantity reel of 250.

# CD54/74HC161, CD54/74HCT161, CD54/74HC163, CD54/74HCT163

## Pinout

CD54HC161, CD54HCT161, CD54HC163, CD54HCT163  
(CERDIP)  
CD74HC161, CD74HCT161, CD74HC163, CD74HCT163  
(PDIP, SOIC)  
TOP VIEW



## Functional Diagram



**CD54/74HC161, CD54/74HCT161, CD54/74HC163, CD54/74HCT163**

**MODE SELECT - FUNCTION TABLE FOR 'HC161 AND 'HCT161**

OPERATING MODE	INPUTS						OUTPUTS	
	$\overline{MR}$	CP	PE	TE	$\overline{SP\overline{E}}$	$P_n$	$Q_n$	TC
Reset (Clear)	L	X	X	X	X	X	L	L
Parallel Load	H	↑	X	X	l	l	L	L
	H	↑	X	X	l	h	H	(Note 1)
Count	H	↑	h	h	h (Note 3)	X	Count	(Note 1)
Inhibit	H	X	l (Note 2)	X	h (Note 3)	X	$q_n$	(Note 1)
	H	X	X	l (Note 2)	h (Note 3)	X	$q_n$	L

**MODE SELECT - FUNCTION TABLE FOR 'HC163 AND 'HCT163**

OPERATING MODE	INPUTS						OUTPUTS	
	$\overline{MR}$	CP	PE	TE	$\overline{SP\overline{E}}$	$P_n$	$Q_n$	TC
Reset (Clear)	l	↑	X	X	X	X	L	L
Parallel Load	h (Note 3)	↑	X	X	l	l	L	L
	h (Note 3)	↑	X	X	l	h	H	(Note 1)
Count	h (Note 3)	↑	h	h	h (Note 3)	X	Count	(Note 1)
Inhibit	h (Note 3)	X	l (Note 2)	X	h (Note 3)	X	$q_n$	(Note 1)
	h (Note 3)	X	X	l (Note 2)	h (Note 3)	X	$q_n$	L

H = High voltage level steady state; L = Low voltage level steady state; h = High voltage level one setup time prior to the Low-to-High clock transition; l = Low voltage level one setup time prior to the Low-to-High clock transition; X = Don't Care; q = Lower case letters indicate the state of the referenced output prior to the Low-to-High clock transition; ↑ = Low-to-High clock transition.

**NOTES:**

1. The TC output is High when TE is High and the counter is at Terminal Count (HHHH for HC/HCT161 and 'HC/HCT163).
2. The High-to-Low transition of PE or TE on the 'HC/HCT161 and the 'HC/HCT163 should only occur while CP is HIGH for conventional operation.
3. The Low-to-High transition of  $\overline{SP\overline{E}}$  on the 'HC/HCT161 and  $\overline{SP\overline{E}}$  or  $\overline{MR}$  on the 'HC/HCT163 should only occur while CP is HIGH for conventional operation.

# CD54/74HC161, CD54/74HCT161, CD54/74HC163, CD54/74HCT163

## Absolute Maximum Ratings

DC Supply Voltage, $V_{CC}$ .....	-0.5V to 7V
DC Input Diode Current, $I_{IK}$	
For $V_I < -0.5V$ or $V_I > V_{CC} + 0.5V$ .....	$\pm 20mA$
DC Output Diode Current, $I_{OK}$	
For $V_O < -0.5V$ or $V_O > V_{CC} + 0.5V$ .....	$\pm 20mA$
DC Drain Current, per Output, $I_O$	
For $-0.5V < V_O < V_{CC} + 0.5V$ .....	$\pm 25mA$
DC Output Source or Sink Current per Output Pin, $I_O$	
For $V_O > -0.5V$ or $V_O < V_{CC} + 0.5V$ .....	$\pm 25mA$
DC $V_{CC}$ or Ground Current, $I_{CC}$ .....	$\pm 50mA$

## Thermal Information

Thermal Resistance (Typical, Note 4)	$\theta_{JA}$ ( $^{\circ}C/W$ )
E (PDIP) Package .....	67
M (SOIC) Package .....	73
Maximum Junction Temperature .....	150 $^{\circ}C$
Maximum Storage Temperature Range .....	-65 $^{\circ}C$ to 150 $^{\circ}C$
Maximum Lead Temperature (Soldering 10s) .....	300 $^{\circ}C$ (SOIC - Lead Tips Only)

## Operating Conditions

Temperature Range, $T_A$ .....	-55 $^{\circ}C$ to 125 $^{\circ}C$
Supply Voltage Range, $V_{CC}$	
HC Types .....	.2V to 6V
HCT Types .....	4.5V to 5.5V
DC Input or Output Voltage, $V_I, V_O$ .....	0V to $V_{CC}$
Input Rise and Fall Time	
2V .....	1000ns (Max)
4.5V .....	500ns (Max)
6V .....	400ns (Max)

CAUTION: Stresses above those listed in "Absolute Maximum Ratings" may cause permanent damage to the device. This is a stress only rating and operation of the device at these or any other conditions above those indicated in the operational sections of this specification is not implied.

### NOTE:

- The package thermal impedance is calculated in accordance with JESD 51-7.

## DC Electrical Specifications

PARAMETER	SYMBOL	TEST CONDITIONS		$V_{CC}$ (V)	25 $^{\circ}C$			-40 $^{\circ}C$ TO 85 $^{\circ}C$		-55 $^{\circ}C$ TO 125 $^{\circ}C$		UNITS	
		$V_I$ (V)	$I_O$ (mA)		MIN	TYP	MAX	MIN	MAX	MIN	MAX		
<b>HC TYPES</b>													
High Level Input Voltage	$V_{IH}$	-	-	2	1.5	-	-	1.5	-	1.5	-	V	
				4.5	3.15	-	-	3.15	-	3.15	-	V	
				6	4.2	-	-	4.2	-	4.2	-	V	
Low Level Input Voltage	$V_{IL}$	-	-	2	-	-	0.5	-	0.5	-	0.5	V	
				4.5	-	-	1.35	-	1.35	-	1.35	V	
				6	-	-	1.8	-	1.8	-	1.8	V	
High Level Output Voltage CMOS Loads	$V_{OH}$	$V_{IH}$ or $V_{IL}$	-0.02	-0.02	2	1.9	-	-	1.9	-	1.9	-	V
			-0.02	-0.02	4.5	4.4	-	-	4.4	-	4.4	-	V
			-0.02	-0.02	6	5.9	-	-	5.9	-	5.9	-	V
High Level Output Voltage TTL Loads	$V_{OH}$	$V_{IH}$ or $V_{IL}$	-	-	-	-	-	-	-	-	-	V	
			-4	-4	4.5	3.98	-	-	3.84	-	3.7	-	V
			-5.2	-5.2	6	5.48	-	-	5.34	-	5.2	-	V
Low Level Output Voltage CMOS Loads	$V_{OL}$	$V_{IH}$ or $V_{IL}$	0.02	0.02	2	-	-	0.1	-	0.1	-	0.1	V
			0.02	0.02	4.5	-	-	0.1	-	0.1	-	0.1	V
			0.02	0.02	6	-	-	0.1	-	0.1	-	0.1	V
Low Level Output Voltage TTL Loads	$V_{OL}$	$V_{IH}$ or $V_{IL}$	-	-	-	-	-	-	-	-	-	V	
			4	4	4.5	-	-	0.26	-	0.33	-	0.4	V
			5.2	5.2	6	-	-	0.26	-	0.33	-	0.4	V
Input Leakage Current	$I_I$	$V_{CC}$ or GND	-	6	-	-	$\pm 0.1$	-	$\pm 1$	-	$\pm 1$	$\mu A$	

**CD54/74HC161, CD54/74HCT161, CD54/74HC163, CD54/74HCT163**

**DC Electrical Specifications (Continued)**

PARAMETER	SYMBOL	TEST CONDITIONS		V <sub>CC</sub> (V)	25°C			-40°C TO 85°C		-55°C TO 125°C		UNITS
		V <sub>I</sub> (V)	I <sub>O</sub> (mA)		MIN	TYP	MAX	MIN	MAX	MIN	MAX	
Quiescent Device Current	I <sub>CC</sub>	V <sub>CC</sub> or GND	0	6	-	-	8	-	80	-	160	μA
<b>HCT TYPES</b>												
High Level Input Voltage	V <sub>IH</sub>	-	-	4.5 to 5.5	2	-	-	2	-	2	-	V
Low Level Input Voltage	V <sub>IL</sub>	-	-	4.5 to 5.5	-	-	0.8	-	0.8	-	0.8	V
High Level Output Voltage CMOS Loads	V <sub>OH</sub>	V <sub>IH</sub> or V <sub>IL</sub>	-0.02	4.5	4.4	-	-	4.4	-	4.4	-	V
High Level Output Voltage TTL Loads			-4	4.5	3.98	-	-	3.84	-	3.7	-	V
Low Level Output Voltage CMOS Loads	V <sub>OL</sub>	V <sub>IH</sub> or V <sub>IL</sub>	0.02	4.5	-	-	0.1	-	0.1	-	0.1	V
Low Level Output Voltage TTL Loads			4	4.5	-	-	0.26	-	0.33	-	0.4	V
Input Leakage Current	I <sub>I</sub>	V <sub>CC</sub> and GND	0	5.5	-	-	±0.1	-	±1	-	±1	μA
Quiescent Device Current	I <sub>CC</sub>	V <sub>CC</sub> or GND	0	5.5	-	-	8	-	80	-	160	μA
Additional Quiescent Device Current Per Input Pin: 1 Unit Load	ΔI <sub>CC</sub> (Note 5)	V <sub>CC</sub> -2.1	-	4.5 to 5.5	-	100	360	-	450	-	490	μA

NOTE:

5. For dual-supply systems theoretical worst case (V<sub>I</sub> = 2.4V, V<sub>CC</sub> = 5.5V) specification is 1.8mA.

**HCT Input Loading Table**

INPUT	UNIT LOADS
P0 - P3	0.25
PE	0.65
CP	1.05
MR	0.8
SPE	0.5
TE	1.05

NOTE: Unit Load is ΔI<sub>CC</sub> limit specified in DC Electrical Table, e.g., 360μA max at 25°C.

**CD54/74HC161, CD54/74HCT161, CD54/74HC163, CD54/74HCT163**

**Prerequisite For Switching Specifications**

PARAMETER	SYMBOL	TEST CONDITIONS	V <sub>CC</sub> (V)	25°C			-40°C TO 85°C		-55°C TO 125°C		UNITS
				MIN	TYP	MAX	MIN	MAX	MIN	MAX	
<b>HC TYPES</b>											
Maximum CP Frequency (Note 6)	f <sub>MAX</sub>	-	2	6	-	-	5	-	4	-	MHz
			4.5	30	-	-	24	-	20	-	MHz
			6	35	-	-	28	-	24	-	MHz
CP Width (Low)	t <sub>W(L)</sub>	-	2	80	-	-	100	-	120	-	ns
			4.5	16	-	-	20	-	24	-	ns
			6	14	-	-	17	-	20	-	ns
MR Pulse Width (161)	t <sub>W</sub>	-	2	100	-	-	125	-	150	-	ns
			4.5	20	-	-	25	-	30	-	ns
			6	17	-	-	21	-	26	-	ns
Setup Time, Pn to CP	t <sub>SU</sub>	-	2	60	-	-	75	-	90	-	ns
			4.5	12	-	-	15	-	18	-	ns
			6	10	-	-	13	-	15	-	ns
Setup Time, PE or TE to CP	t <sub>SU</sub>	-	2	50	-	-	65	-	75	-	ns
			4.5	10	-	-	13	-	15	-	ns
			6	9	-	-	11	-	13	-	ns
Setup Time, SPE to CP	t <sub>SU</sub>	-	2	60	-	-	75	-	90	-	ns
			4.5	12	-	-	15	-	18	-	ns
			6	10	-	-	13	-	15	-	ns
Setup Time, MR to CP (163)	t <sub>SU</sub>	-	2	65	-	-	80	-	100	-	ns
			4.5	13	-	-	16	-	20	-	ns
			6	11	-	-	14	-	17	-	ns
Hold Time, PN to CP	t <sub>H</sub>	-	2	3	-	-	3	-	3	-	ns
			4.5	3	-	-	3	-	3	-	ns
			6	3	-	-	3	-	3	-	ns
Hold Time, TE or PE to CP	t <sub>H</sub>	-	2	0	-	-	0	-	0	-	ns
			4.5	0	-	-	0	-	0	-	ns
			6	0	-	-	0	-	0	-	ns
Hold Time, SPE to CP	t <sub>H</sub>	-	2	0	-	-	0	-	0	-	ns
			4.5	0	-	-	0	-	0	-	ns
			6	0	-	-	0	-	0	-	ns
Recovery Time, MR to CP (161)	t <sub>REC</sub>	-	2	75	-	-	95	-	110	-	ns
			4.5	15	-	-	19	-	22	-	ns
			6	13	-	-	16	-	19	-	ns

**CD54/74HC161, CD54/74HCT161, CD54/74HC163, CD54/74HCT163**

**Prerequisite For Switching Specifications (Continued)**

PARAMETER	SYMBOL	TEST CONDITIONS	V <sub>CC</sub> (V)	25°C			-40°C TO 85°C		-55°C TO 125°C		UNITS
				MIN	TYP	MAX	MIN	MAX	MIN	MAX	
<b>HCT TYPES</b>											
Maximum CP Frequency	f <sub>MAX</sub>	-	4.5	30	-	-	24	-	20	-	MHz
CP Width (Low) (Note 6)	t <sub>W(L)</sub>	-	4.5	16	-	-	20	-	24	-	ns
$\overline{MR}$ Pulse Width (161)	t <sub>W</sub>	-	4.5	20	-	-	25	-	30	-	ns
Setup Time, Pn to CP	t <sub>SU</sub>	-	4.5	10	-	-	13	-	15	-	ns
Setup Time, PE or TE to CP	t <sub>SU</sub>	-	4.5	13	-	-	16	-	20	-	ns
Setup Time, $\overline{SPE}$ to CP	t <sub>SU</sub>	-	4.5	12	-	-	15	-	18	-	ns
Setup Time, $\overline{MR}$ to CP (163)	t <sub>SU</sub>	-	4.5	13	-	-	16	-	20	-	ns
Hold Time, PN to CP	t <sub>H</sub>	-	4.5	5	-	-	5	-	5	-	ns
Hold Time, TE or PE to CP	t <sub>H</sub>	-	4.5	3	-	-	3	-	3	-	ns
Hold Time, $\overline{SPE}$ to CP	t <sub>H</sub>	-	4.5	3	-	-	3	-	3	-	ns
Recovery Time, $\overline{MR}$ to CP (161)	t <sub>REC</sub>	-	4.5	15	-	-	19	-	22	-	ns

NOTE:

6. Applies to non-cascaded operation only. With cascaded counters clock to terminal count propagation delays, count enables (PE or TE)-to-clock setup times, and count enables (PE or TE)-to-clock hold times determine maximum clock frequency. For example with these HC devices:

$$f_{\text{MAX}} (\text{CP}) = \frac{1}{\text{CP-to-TC prop. delay} + \text{TE-to-CP setup} + \text{TE-to-CP Hold}} = \frac{1}{37 + 10 + 0} \approx 21\text{MHz}(\text{min})$$

**Switching Specifications** C<sub>L</sub> = 50pF, Input t<sub>r</sub>, t<sub>f</sub> = 6ns

PARAMETER	SYMBOL	TEST CONDITIONS	V <sub>CC</sub> (V)	25°C			-40°C TO 85°C		-55°C TO 125°C		UNITS
				MIN	TYP	MAX	MIN	MAX	MIN	MAX	
<b>HC TYPES</b>											
Propagation Delay CP to TC	t <sub>PHL</sub> , t <sub>PLH</sub>	C <sub>L</sub> = 50pF	2	-	-	185	-	230	-	280	ns
			4.5	-	-	37	-	46	-	56	ns
		C <sub>L</sub> = 15pF	5	-	15	-	-	-	-	-	ns
		C <sub>L</sub> = 50pF	6	-	-	31	-	39	-	48	ns
CP to Qn	t <sub>PHL</sub> , t <sub>PLH</sub>	C <sub>L</sub> = 50pF	2	-	-	185	-	230	-	280	ns
			4.5	-	-	37	-	46	-	56	ns
		C <sub>L</sub> = 15pF	5	-	15	-	-	-	-	-	ns
		C <sub>L</sub> = 50pF	6	-	-	31	-	39	-	48	ns
TE to TC	t <sub>PHL</sub> , t <sub>PLH</sub>	C <sub>L</sub> = 50pF	2	-	-	120	-	150	-	180	ns
			4.5	-	-	24	-	30	-	36	ns
		C <sub>L</sub> = 15pF	5	-	9	-	-	-	-	-	ns
		C <sub>L</sub> = 50pF	6	-	-	20	-	26	-	31	ns

**CD54/74HC161, CD54/74HCT161, CD54/74HC163, CD54/74HCT163**

**Switching Specifications**  $C_L = 50\text{pF}$ , Input  $t_r$ ,  $t_f = 6\text{ns}$  (Continued)

PARAMETER	SYMBOL	TEST CONDITIONS	$V_{CC}$ (V)	25°C			-40°C TO 85°C		-55°C TO 125°C		UNITS
				MIN	TYP	MAX	MIN	MAX	MIN	MAX	
$\overline{MR}$ to Qn (161)	$t_{PHL}$	$C_L = 50\text{pF}$	2	-	-	210	-	265	-	315	ns
			4.5	-	-	42	-	53	-	63	ns
		$C_L = 15\text{pF}$	5	-	18	-	-	-	-	-	ns
		$C_L = 50\text{pF}$	6	-	-	36	-	45	-	54	ns
$\overline{MR}$ to TC (161)	$t_{PHL}$	$C_L = 50\text{pF}$	2	-	-	210	-	265	-	315	ns
			4.5	-	-	42	-	53	-	63	ns
		$C_L = 50\text{pF}$	6	-	-	36	-	45	-	54	ns
Output Transition Time	$t_{THL}, t_{TLH}$	$C_L = 50\text{pF}$	2	-	-	75	-	95	-	110	ns
			4.5	-	-	15	-	19	-	22	ns
			6	-	-	13	-	16	-	19	ns
Power Dissipation Capacitance (Notes 7, 8)	$C_{PD}$	-	5	-	60	-	-	-	-	-	pF
Input Capacitance	$C_{IN}$	$C_L = 50\text{pF}$	-	10	-	10	-	10	-	10	pF

**HCT TYPES**

Propagation Delay CP to TC	$t_{PHL}, t_{PLH}$	$C_L = 50\text{pF}$	4.5	-	-	42	-	53	-	63	ns
		$C_L = 15\text{pF}$	5	-	18	-	-	-	-	-	ns
CP to Qn	$t_{PHL}, t_{PLH}$	$C_L = 50\text{pF}$	4.5	-	-	39	-	49	-	59	ns
		$C_L = 15\text{pF}$	5	-	16	-	-	-	-	-	ns
TE to TC	$t_{PHL}, t_{PLH}$	$C_L = 50\text{pF}$	4.5	-	-	32	-	40	-	48	ns
		$C_L = 15\text{pF}$	5	-	13	-	-	-	-	-	ns
$\overline{MR}$ to Qn (161)	$t_{PHL}$	$C_L = 50\text{pF}$	4.5	-	-	50	-	63	-	75	ns
		$C_L = 15\text{pF}$	5	-	21	-	-	-	-	-	ns
$\overline{MR}$ to TC (161)	$t_{PHL}$	$C_L = 50\text{pF}$	4.5	-	-	50	-	63	-	75	ns
Output Transition Time	$t_{THL}, t_{TLH}$	$C_L = 50\text{pF}$	4.5	-	-	15	-	19	-	22	ns
Power Dissipation Capacitance (Notes 7, 8)	$C_{PD}$	-	5	-	63	-	-	-	-	-	pF
Input Capacitance	$C_{IN}$	$C_L = 50\text{pF}$	-	10	-	10	-	10	-	10	pF

**NOTES:**

7.  $C_{PD}$  is used to determine the dynamic power consumption, per package.

8.  $P_D = C_{PD} V_{CC}^2 f_i + \sum (C_L V_{CC}^2 f_O)$  where  $f_i$  = Input Frequency,  $f_O$  = Output Frequency,  $C_L$  = Output Load Capacitance,  $V_{CC}$  = Supply Voltage.



**Timing Diagram**

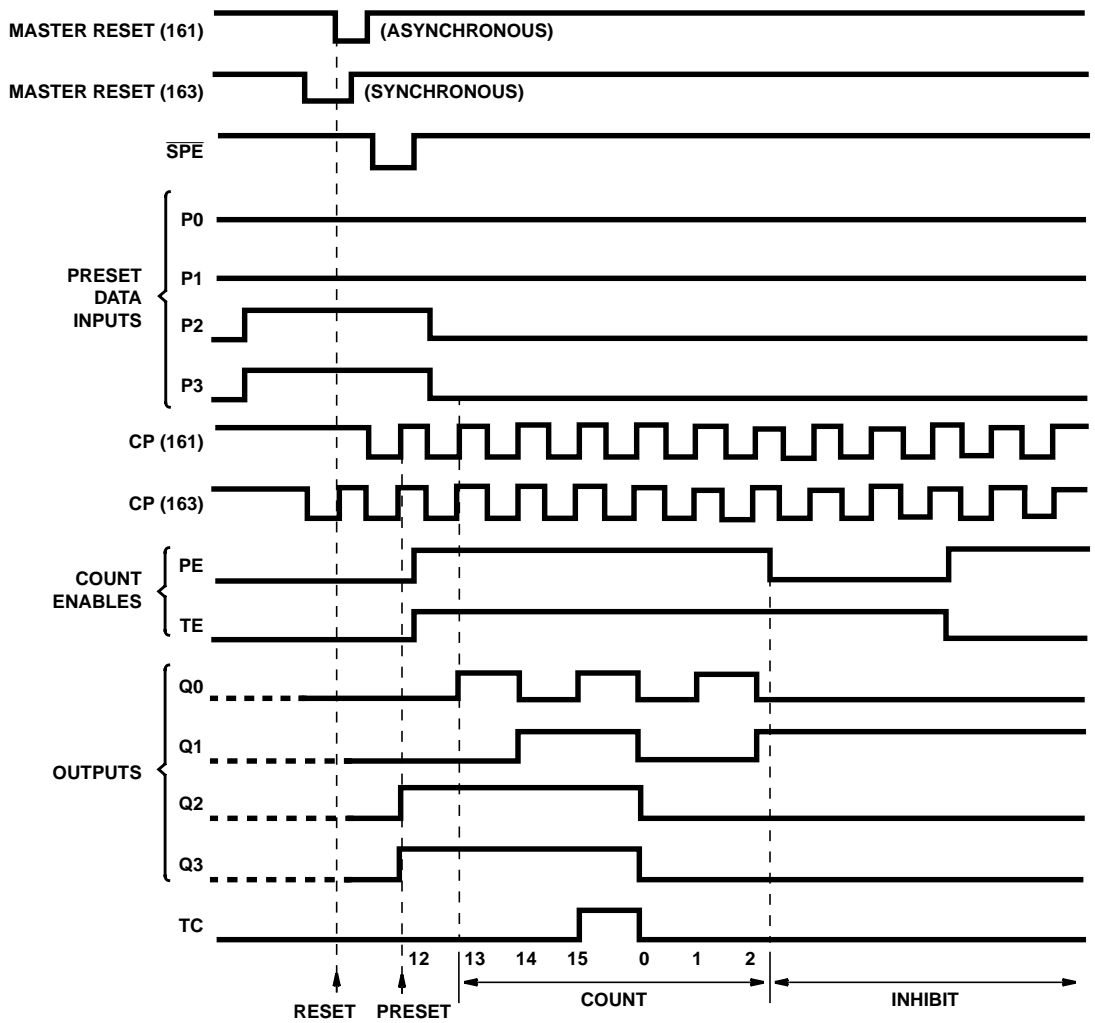

Sequence illustrated on waveforms:

1. Reset outputs to zero.
2. Preset to binary twelve.
3. Count to thirteen, fourteen, fifteen, zero, one, and two.
4. Inhibit.

Test Circuits and Waveforms

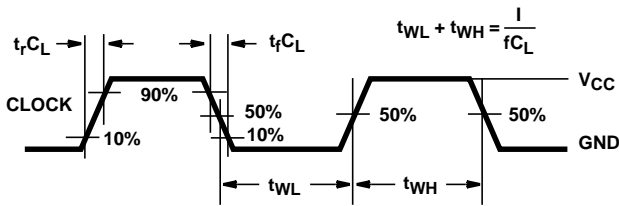

NOTE: Outputs should be switching from 10%  $V_{CC}$  to 90%  $V_{CC}$  in accordance with device truth table. For  $f_{MAX}$ , input duty cycle = 50%.

FIGURE 1. HC CLOCK PULSE RISE AND FALL TIMES AND PULSE WIDTH

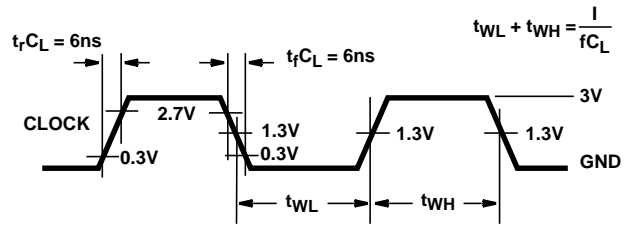

NOTE: Outputs should be switching from 10%  $V_{CC}$  to 90%  $V_{CC}$  in accordance with device truth table. For  $f_{MAX}$ , input duty cycle = 50%.

FIGURE 2. HCT CLOCK PULSE RISE AND FALL TIMES AND PULSE WIDTH

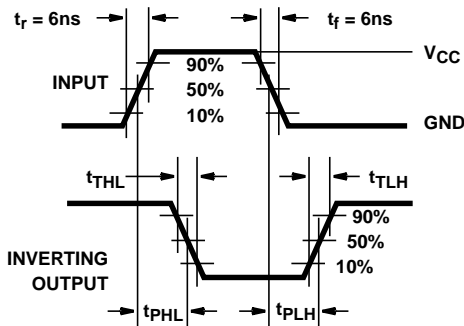

FIGURE 3. HC TRANSITION TIMES AND PROPAGATION DELAY TIMES, COMBINATION LOGIC

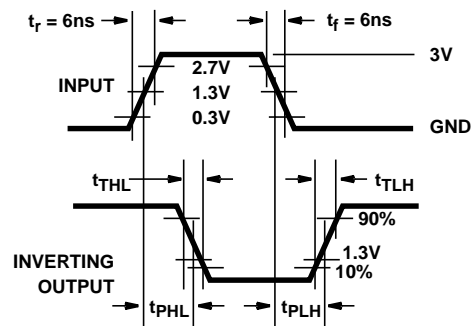

FIGURE 4. HCT TRANSITION TIMES AND PROPAGATION DELAY TIMES, COMBINATION LOGIC



FIGURE 5. HC SETUP TIMES, HOLD TIMES, REMOVAL TIME, AND PROPAGATION DELAY TIMES FOR EDGE TRIGGERED SEQUENTIAL LOGIC CIRCUITS

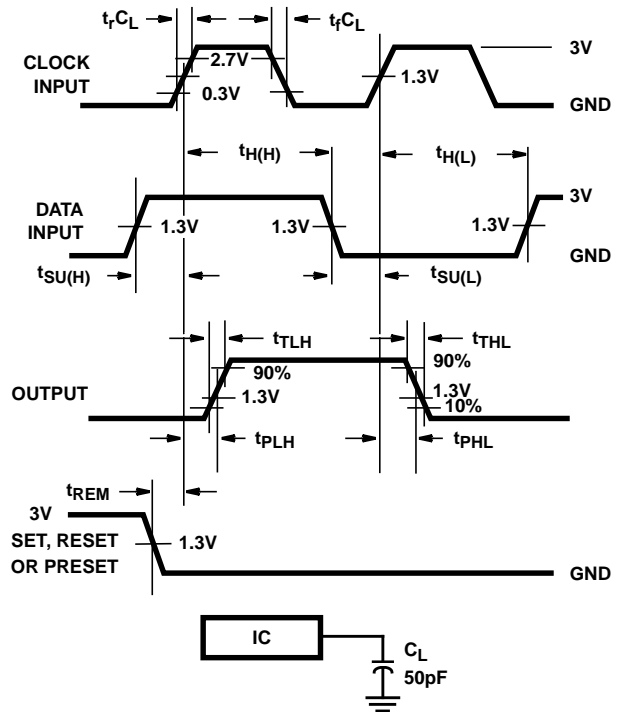

FIGURE 6. HCT SETUP TIMES, HOLD TIMES, REMOVAL TIME, AND PROPAGATION DELAY TIMES FOR EDGE TRIGGERED SEQUENTIAL LOGIC CIRCUITS

**PACKAGING INFORMATION**

Orderable Device	Status (1)	Package Type	Package Drawing	Pins	Package Qty	Eco Plan (2)	Lead/Ball Finish (6)	MSL Peak Temp (3)	Op Temp (°C)	Device Marking (4/5)	Samples
CD54HC161F	ACTIVE	CDIP	J	16	1	TBD	A42	N / A for Pkg Type	-55 to 125	CD54HC161F	<a href="#">Samples</a>
CD54HC161F3A	ACTIVE	CDIP	J	16	1	TBD	A42	N / A for Pkg Type	-55 to 125	8407501EA CD54HC161F3A	<a href="#">Samples</a>
CD54HC163F3A	ACTIVE	CDIP	J	16	1	TBD	A42	N / A for Pkg Type	-55 to 125	8607601EA CD54HC163F3A	<a href="#">Samples</a>
CD54HCT163F	ACTIVE	CDIP	J	16	1	TBD	A42	N / A for Pkg Type	-55 to 125	CD54HCT163F	<a href="#">Samples</a>
CD54HCT163F3A	ACTIVE	CDIP	J	16	1	TBD	A42	N / A for Pkg Type	-55 to 125	CD54HCT163F3A	<a href="#">Samples</a>
CD74HC161E	ACTIVE	PDIP	N	16	25	Green (RoHS & no Sb/Br)	CU NIPDAU	N / A for Pkg Type	-55 to 125	CD74HC161E	<a href="#">Samples</a>
CD74HC161M	ACTIVE	SOIC	D	16	40	Green (RoHS & no Sb/Br)	CU NIPDAU	Level-1-260C-UNLIM	-55 to 125	HC161M	<a href="#">Samples</a>
CD74HC161M96	ACTIVE	SOIC	D	16	2500	Green (RoHS & no Sb/Br)	CU NIPDAU	Level-1-260C-UNLIM	-55 to 125	HC161M	<a href="#">Samples</a>
CD74HC161M96G4	ACTIVE	SOIC	D	16	2500	Green (RoHS & no Sb/Br)	CU NIPDAU	Level-1-260C-UNLIM	-55 to 125	HC161M	<a href="#">Samples</a>
CD74HC163E	ACTIVE	PDIP	N	16	25	Green (RoHS & no Sb/Br)	CU NIPDAU	N / A for Pkg Type	-55 to 125	CD74HC163E	<a href="#">Samples</a>
CD74HC163M	ACTIVE	SOIC	D	16	40	Green (RoHS & no Sb/Br)	CU NIPDAU	Level-1-260C-UNLIM	-55 to 125	HC163M	<a href="#">Samples</a>
CD74HC163M96	ACTIVE	SOIC	D	16	2500	Green (RoHS & no Sb/Br)	CU NIPDAU	Level-1-260C-UNLIM	-55 to 125	HC163M	<a href="#">Samples</a>
CD74HC163MG4	ACTIVE	SOIC	D	16	40	Green (RoHS & no Sb/Br)	CU NIPDAU	Level-1-260C-UNLIM	-55 to 125	HC163M	<a href="#">Samples</a>
CD74HC163MT	ACTIVE	SOIC	D	16	250	Green (RoHS & no Sb/Br)	CU NIPDAU	Level-1-260C-UNLIM	-55 to 125	HC163M	<a href="#">Samples</a>
CD74HCT161E	ACTIVE	PDIP	N	16	25	Green (RoHS & no Sb/Br)	CU NIPDAU	N / A for Pkg Type	-55 to 125	CD74HCT161E	<a href="#">Samples</a>
CD74HCT161EE4	ACTIVE	PDIP	N	16	25	Green (RoHS & no Sb/Br)	CU NIPDAU	N / A for Pkg Type	-55 to 125	CD74HCT161E	<a href="#">Samples</a>
CD74HCT161M	ACTIVE	SOIC	D	16	40	Green (RoHS & no Sb/Br)	CU NIPDAU	Level-1-260C-UNLIM	-55 to 125	HCT161M	<a href="#">Samples</a>

Orderable Device	Status (1)	Package Type	Package Drawing	Pins	Package Qty	Eco Plan (2)	Lead/Ball Finish (6)	MSL Peak Temp (3)	Op Temp (°C)	Device Marking (4/5)	Samples
CD74HCT161M96	ACTIVE	SOIC	D	16	2500	Green (RoHS & no Sb/Br)	CU NIPDAU	Level-1-260C-UNLIM	-55 to 125	HCT161M	<a href="#">Samples</a>
CD74HCT161MG4	ACTIVE	SOIC	D	16	40	Green (RoHS & no Sb/Br)	CU NIPDAU	Level-1-260C-UNLIM	-55 to 125	HCT161M	<a href="#">Samples</a>
CD74HCT163E	ACTIVE	PDIP	N	16	25	Green (RoHS & no Sb/Br)	CU NIPDAU	N / A for Pkg Type	-55 to 125	CD74HCT163E	<a href="#">Samples</a>
CD74HCT163M	ACTIVE	SOIC	D	16	40	Green (RoHS & no Sb/Br)	CU NIPDAU	Level-1-260C-UNLIM	-55 to 125	HCT163M	<a href="#">Samples</a>
CD74HCT163M96	ACTIVE	SOIC	D	16	2500	Green (RoHS & no Sb/Br)	CU NIPDAU	Level-1-260C-UNLIM	-55 to 125	HCT163M	<a href="#">Samples</a>

(1) The marketing status values are defined as follows:

**ACTIVE:** Product device recommended for new designs.

**LIFEBUY:** TI has announced that the device will be discontinued, and a lifetime-buy period is in effect.

**NRND:** Not recommended for new designs. Device is in production to support existing customers, but TI does not recommend using this part in a new design.

**PREVIEW:** Device has been announced but is not in production. Samples may or may not be available.

**OBSELETE:** TI has discontinued the production of the device.

(2) **RoHS:** TI defines "RoHS" to mean semiconductor products that are compliant with the current EU RoHS requirements for all 10 RoHS substances, including the requirement that RoHS substance do not exceed 0.1% by weight in homogeneous materials. Where designed to be soldered at high temperatures, "RoHS" products are suitable for use in specified lead-free processes. TI may reference these types of products as "Pb-Free".

**RoHS Exempt:** TI defines "RoHS Exempt" to mean products that contain lead but are compliant with EU RoHS pursuant to a specific EU RoHS exemption.

**Green:** TI defines "Green" to mean the content of Chlorine (Cl) and Bromine (Br) based flame retardants meet JS709B low halogen requirements of <=1000ppm threshold. Antimony trioxide based flame retardants must also meet the <=1000ppm threshold requirement.

(3) MSL, Peak Temp. - The Moisture Sensitivity Level rating according to the JEDEC industry standard classifications, and peak solder temperature.

(4) There may be additional marking, which relates to the logo, the lot trace code information, or the environmental category on the device.

(5) Multiple Device Markings will be inside parentheses. Only one Device Marking contained in parentheses and separated by a "-" will appear on a device. If a line is indented then it is a continuation of the previous line and the two combined represent the entire Device Marking for that device.

(6) Lead/Ball Finish - Orderable Devices may have multiple material finish options. Finish options are separated by a vertical ruled line. Lead/Ball Finish values may wrap to two lines if the finish value exceeds the maximum column width.

**Important Information and Disclaimer:** The information provided on this page represents TI's knowledge and belief as of the date that it is provided. TI bases its knowledge and belief on information provided by third parties, and makes no representation or warranty as to the accuracy of such information. Efforts are underway to better integrate information from third parties. TI has taken and

continues to take reasonable steps to provide representative and accurate information but may not have conducted destructive testing or chemical analysis on incoming materials and chemicals. TI and TI suppliers consider certain information to be proprietary, and thus CAS numbers and other limited information may not be available for release.

In no event shall TI's liability arising out of such information exceed the total purchase price of the TI part(s) at issue in this document sold by TI to Customer on an annual basis.

**OTHER QUALIFIED VERSIONS OF CD54HC161, CD54HC163, CD54HCT163, CD74HC161, CD74HC163, CD74HCT163 :**

- Catalog: [CD74HC161](#), [CD74HC163](#), [CD74HCT163](#)
- Military: [CD54HC161](#), [CD54HC163](#), [CD54HCT163](#)

NOTE: Qualified Version Definitions:

- Catalog - TI's standard catalog product
- Military - QML certified for Military and Defense Applications

**TAPE AND REEL INFORMATION**



**QUADRANT ASSIGNMENTS FOR PIN 1 ORIENTATION IN TAPE**



\*All dimensions are nominal

Device	Package Type	Package Drawing	Pins	SPQ	Reel Diameter (mm)	Reel Width W1 (mm)	A0 (mm)	B0 (mm)	K0 (mm)	P1 (mm)	W (mm)	Pin1 Quadrant
CD74HC161M96	SOIC	D	16	2500	330.0	16.4	6.5	10.3	2.1	8.0	16.0	Q1
CD74HC163M96	SOIC	D	16	2500	330.0	16.4	6.5	10.3	2.1	8.0	16.0	Q1
CD74HCT161M96	SOIC	D	16	2500	330.0	16.4	6.5	10.3	2.1	8.0	16.0	Q1
CD74HCT163M96	SOIC	D	16	2500	330.0	16.4	6.5	10.3	2.1	8.0	16.0	Q1

**TAPE AND REEL BOX DIMENSIONS**



\*All dimensions are nominal

Device	Package Type	Package Drawing	Pins	SPQ	Length (mm)	Width (mm)	Height (mm)
CD74HC161M96	SOIC	D	16	2500	333.2	345.9	28.6
CD74HC163M96	SOIC	D	16	2500	333.2	345.9	28.6
CD74HCT161M96	SOIC	D	16	2500	333.2	345.9	28.6
CD74HCT163M96	SOIC	D	16	2500	333.2	345.9	28.6

J (R-GDIP-T\*\*)

14 LEADS SHOWN

CERAMIC DUAL IN-LINE PACKAGE



DIM \ PINS **	14	16	18	20
A	0.300 (7,62) BSC	0.300 (7,62) BSC	0.300 (7,62) BSC	0.300 (7,62) BSC
B MAX	0.785 (19,94)	.840 (21,34)	0.960 (24,38)	1.060 (26,92)
B MIN	—	—	—	—
C MAX	0.300 (7,62)	0.300 (7,62)	0.310 (7,87)	0.300 (7,62)
C MIN	0.245 (6,22)	0.245 (6,22)	0.220 (5,59)	0.245 (6,22)



4040083/F 03/03

- NOTES:
- All linear dimensions are in inches (millimeters).
  - This drawing is subject to change without notice.
  - This package is hermetically sealed with a ceramic lid using glass frit.
  - Index point is provided on cap for terminal identification only on press ceramic glass frit seal only.
  - Falls within MIL STD 1835 GDIP1-T14, GDIP1-T16, GDIP1-T18 and GDIP1-T20.



N (R-PDIP-T\*\*)

PLASTIC DUAL-IN-LINE PACKAGE

16 PINS SHOWN



- NOTES:
- A. All linear dimensions are in inches (millimeters).
  - B. This drawing is subject to change without notice.
  - $\triangle C$  Falls within JEDEC MS-001, except 18 and 20 pin minimum body length (Dim A).
  - $\triangle D$  The 20 pin end lead shoulder width is a vendor option, either half or full width.

D (R-PDSO-G16)

PLASTIC SMALL OUTLINE



- NOTES:
- A. All linear dimensions are in inches (millimeters).
  - B. This drawing is subject to change without notice.
  - C. Body length does not include mold flash, protrusions, or gate burrs. Mold flash, protrusions, or gate burrs shall not exceed 0.006 (0,15) each side.
  - D. Body width does not include interlead flash. Interlead flash shall not exceed 0.017 (0,43) each side.
  - E. Reference JEDEC MS-012 variation AC.

D (R-PDSO-G16)

PLASTIC SMALL OUTLINE

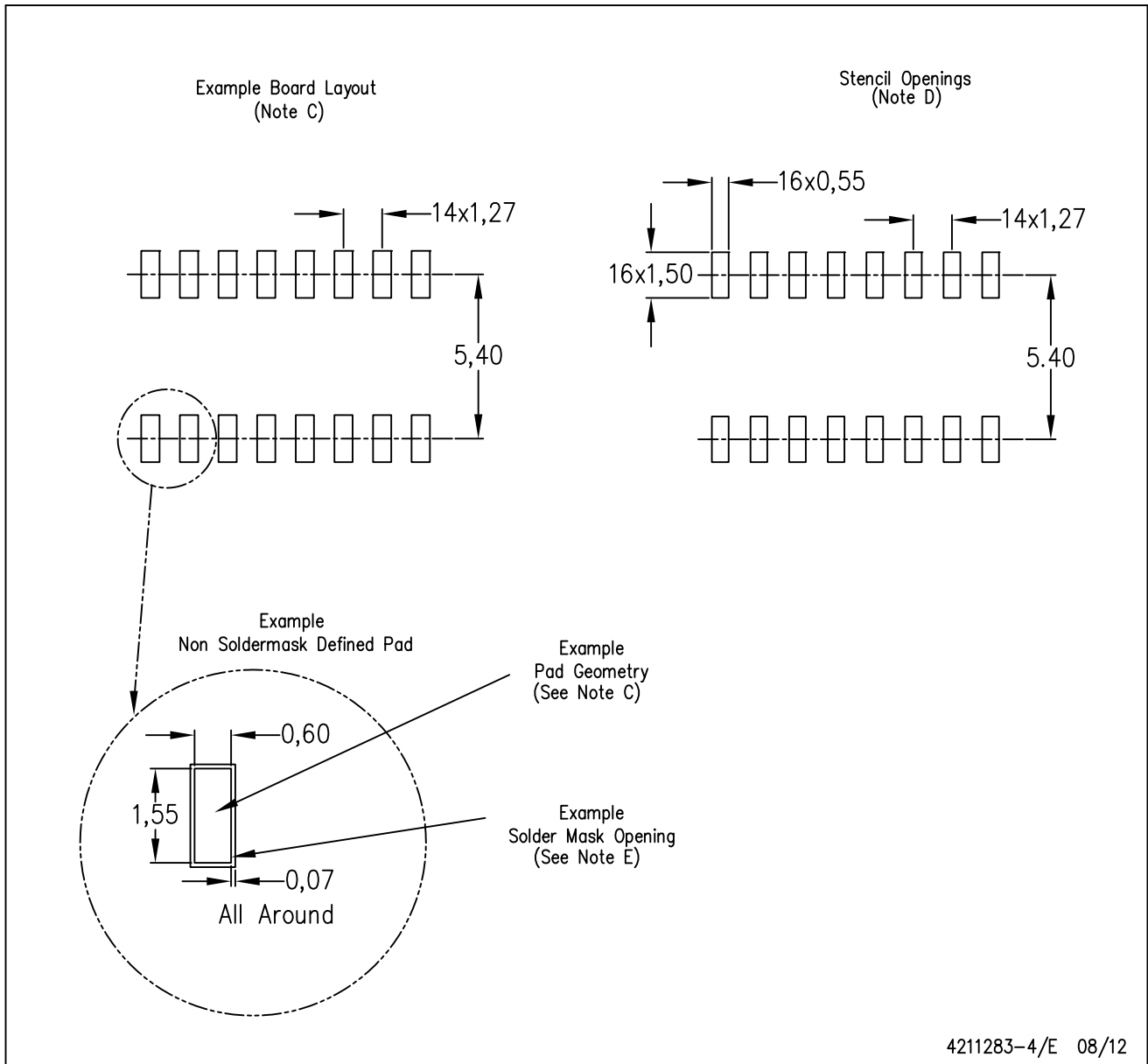

- NOTES:
- A. All linear dimensions are in millimeters.
  - B. This drawing is subject to change without notice.
  - C. Publication IPC-7351 is recommended for alternate designs.
  - D. Laser cutting apertures with trapezoidal walls and also rounding corners will offer better paste release. Customers should contact their board assembly site for stencil design recommendations. Refer to IPC-7525 for other stencil recommendations.
  - E. Customers should contact their board fabrication site for solder mask tolerances between and around signal pads.

## IMPORTANT NOTICE

Texas Instruments Incorporated (TI) reserves the right to make corrections, enhancements, improvements and other changes to its semiconductor products and services per JESD46, latest issue, and to discontinue any product or service per JESD48, latest issue. Buyers should obtain the latest relevant information before placing orders and should verify that such information is current and complete.

TI's published terms of sale for semiconductor products (<http://www.ti.com/sc/docs/stdterms.htm>) apply to the sale of packaged integrated circuit products that TI has qualified and released to market. Additional terms may apply to the use or sale of other types of TI products and services.

Reproduction of significant portions of TI information in TI data sheets is permissible only if reproduction is without alteration and is accompanied by all associated warranties, conditions, limitations, and notices. TI is not responsible or liable for such reproduced documentation. Information of third parties may be subject to additional restrictions. Resale of TI products or services with statements different from or beyond the parameters stated by TI for that product or service voids all express and any implied warranties for the associated TI product or service and is an unfair and deceptive business practice. TI is not responsible or liable for any such statements.

Buyers and others who are developing systems that incorporate TI products (collectively, "Designers") understand and agree that Designers remain responsible for using their independent analysis, evaluation and judgment in designing their applications and that Designers have full and exclusive responsibility to assure the safety of Designers' applications and compliance of their applications (and of all TI products used in or for Designers' applications) with all applicable regulations, laws and other applicable requirements. Designer represents that, with respect to their applications, Designer has all the necessary expertise to create and implement safeguards that (1) anticipate dangerous consequences of failures, (2) monitor failures and their consequences, and (3) lessen the likelihood of failures that might cause harm and take appropriate actions. Designer agrees that prior to using or distributing any applications that include TI products, Designer will thoroughly test such applications and the functionality of such TI products as used in such applications.

TI's provision of technical, application or other design advice, quality characterization, reliability data or other services or information, including, but not limited to, reference designs and materials relating to evaluation modules, (collectively, "TI Resources") are intended to assist designers who are developing applications that incorporate TI products; by downloading, accessing or using TI Resources in any way, Designer (individually or, if Designer is acting on behalf of a company, Designer's company) agrees to use any particular TI Resource solely for this purpose and subject to the terms of this Notice.

TI's provision of TI Resources does not expand or otherwise alter TI's applicable published warranties or warranty disclaimers for TI products, and no additional obligations or liabilities arise from TI providing such TI Resources. TI reserves the right to make corrections, enhancements, improvements and other changes to its TI Resources. TI has not conducted any testing other than that specifically described in the published documentation for a particular TI Resource.

Designer is authorized to use, copy and modify any individual TI Resource only in connection with the development of applications that include the TI product(s) identified in such TI Resource. NO OTHER LICENSE, EXPRESS OR IMPLIED, BY ESTOPPEL OR OTHERWISE TO ANY OTHER TI INTELLECTUAL PROPERTY RIGHT, AND NO LICENSE TO ANY TECHNOLOGY OR INTELLECTUAL PROPERTY RIGHT OF TI OR ANY THIRD PARTY IS GRANTED HEREIN, including but not limited to any patent right, copyright, mask work right, or other intellectual property right relating to any combination, machine, or process in which TI products or services are used. Information regarding or referencing third-party products or services does not constitute a license to use such products or services, or a warranty or endorsement thereof. Use of TI Resources may require a license from a third party under the patents or other intellectual property of the third party, or a license from TI under the patents or other intellectual property of TI.

TI RESOURCES ARE PROVIDED "AS IS" AND WITH ALL FAULTS. TI DISCLAIMS ALL OTHER WARRANTIES OR REPRESENTATIONS, EXPRESS OR IMPLIED, REGARDING RESOURCES OR USE THEREOF, INCLUDING BUT NOT LIMITED TO ACCURACY OR COMPLETENESS, TITLE, ANY EPIDEMIC FAILURE WARRANTY AND ANY IMPLIED WARRANTIES OF MERCHANTABILITY, FITNESS FOR A PARTICULAR PURPOSE, AND NON-INFRINGEMENT OF ANY THIRD PARTY INTELLECTUAL PROPERTY RIGHTS. TI SHALL NOT BE LIABLE FOR AND SHALL NOT DEFEND OR INDEMNIFY DESIGNER AGAINST ANY CLAIM, INCLUDING BUT NOT LIMITED TO ANY INFRINGEMENT CLAIM THAT RELATES TO OR IS BASED ON ANY COMBINATION OF PRODUCTS EVEN IF DESCRIBED IN TI RESOURCES OR OTHERWISE. IN NO EVENT SHALL TI BE LIABLE FOR ANY ACTUAL, DIRECT, SPECIAL, COLLATERAL, INDIRECT, PUNITIVE, INCIDENTAL, CONSEQUENTIAL OR EXEMPLARY DAMAGES IN CONNECTION WITH OR ARISING OUT OF TI RESOURCES OR USE THEREOF, AND REGARDLESS OF WHETHER TI HAS BEEN ADVISED OF THE POSSIBILITY OF SUCH DAMAGES.

Unless TI has explicitly designated an individual product as meeting the requirements of a particular industry standard (e.g., ISO/TS 16949 and ISO 26262), TI is not responsible for any failure to meet such industry standard requirements.

Where TI specifically promotes products as facilitating functional safety or as compliant with industry functional safety standards, such products are intended to help enable customers to design and create their own applications that meet applicable functional safety standards and requirements. Using products in an application does not by itself establish any safety features in the application. Designers must ensure compliance with safety-related requirements and standards applicable to their applications. Designer may not use any TI products in life-critical medical equipment unless authorized officers of the parties have executed a special contract specifically governing such use. Life-critical medical equipment is medical equipment where failure of such equipment would cause serious bodily injury or death (e.g., life support, pacemakers, defibrillators, heart pumps, neurostimulators, and implantables). Such equipment includes, without limitation, all medical devices identified by the U.S. Food and Drug Administration as Class III devices and equivalent classifications outside the U.S.

TI may expressly designate certain products as completing a particular qualification (e.g., Q100, Military Grade, or Enhanced Product). Designers agree that it has the necessary expertise to select the product with the appropriate qualification designation for their applications and that proper product selection is at Designers' own risk. Designers are solely responsible for compliance with all legal and regulatory requirements in connection with such selection.

Designer will fully indemnify TI and its representatives against any damages, costs, losses, and/or liabilities arising out of Designer's non-compliance with the terms and provisions of this Notice.