

Distributed by:

**JAMECO**<sup>®</sup>  
ELECTRONICS

**www.Jameco.com ♦ 1-800-831-4242**

The content and copyrights of the attached  
material are the property of its owner.

Jameco Part Number 495314

**Circular Plastic Connectors, Size 1**

**CPC Connectors, Series 1  
for Cable or Panel Mount**  
(Accepts Type III+, High-Current Power, Type II and Subminiature Coax Contacts)



CPC  
Series 1

Listed part numbers are for connectors only; **contacts must be ordered separately.**

**Material**

**Housing**—Thermoplastic, 94V-0 rated, black

**Related Product Data**

- Contacts**—Pages 16-22
- Contact Arrangement**—Page 23
- Component Dimensions**—Page 24\*
- Accessories**—Pages 37-41, 51-53
- Performance Characteristics**—Page 6
- Application Tooling**—Pages 75-78
- Technical Documents**—Page 79

**Replacement Coupling Rings**

Shell Size	Part No.
11	213811-1
13	213813-1
17	213810-1
23	213812-1

**Keying**

Molded-in keying in two configurations:

**A**—Standard Configuration: 5 Keys



**B**—Optional Configuration: 4 Keys to prevent mismatching of standard and reverse sex.



**Square Flange Receptacle**

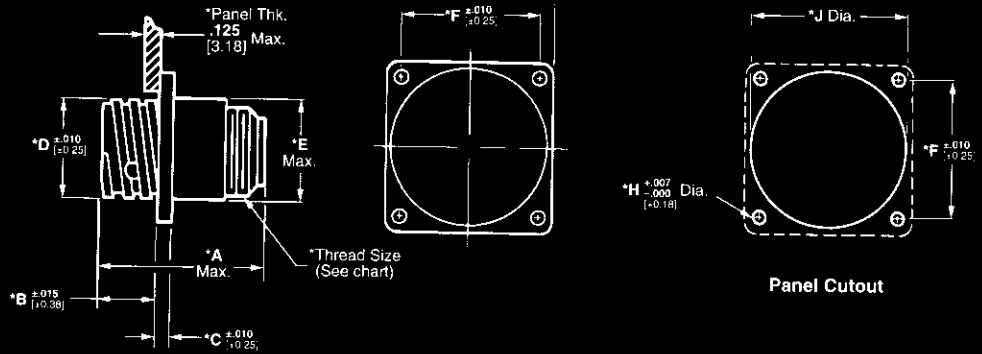

**Free-Hanging Receptacle**

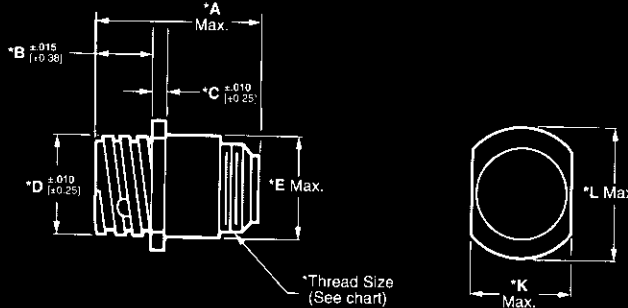

\*Note:  
See page 24 for callout dimensions

**Plug**

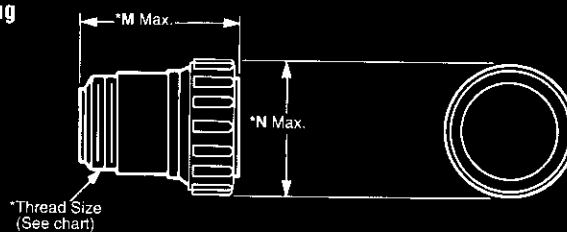

**Standard Sex Connectors** (Receptacles accept pin contacts, Plugs accept socket contacts)

Arrangement Shell No. of Size Positions	Keying	Square Flange Receptacle		Free-Hanging Receptacle	Plug
		With Threaded Inserts <sup>1</sup>	With Mounting Holes		
11-4	A	208130-1	206061-1	206153-1	206060-1
13-9	A	208131-1	206705-1	206705-2	206708-1
17-16	A	206036-8	206036-1	206036-3	206037-1
	B	—	213862-1	—	213849-1
23-24	A	211839-1	206838-1	206838-2	206837-1
	B	—	213866-1	—	213851-1
23-37	A	787610-1	206151-1	206151-2	206150-1
	B	—	213860-1	—	213848-1

<sup>1</sup>Four 4-40 threaded inserts per receptacle.

**Reverse Sex Connectors** (Receptacles accept socket contacts, Plugs accept pin contacts)

Arrangement Shell No. of Size Positions	Keying	Square Flange Receptacle		Free-Hanging Receptacle	Plug
		With Threaded Inserts <sup>1</sup>	With Mounting Holes		
11-4	A	211102-1	206430-1	206430-2	206429-1
17-14	A	211103-1	206043-1	206043-3	206044-1
	B	—	796437-2	—	796449-1
23-37	A	206306-5	206306-1	206306-2	206305-1
	B	—	213864-1	—	213850-1

<sup>1</sup>Four 4-40 threaded inserts per receptacle.

Key Style "A" is the Standard 5 Locating Key arrangement. Key Style "B" is the 4 Locating Key arrangement.