

Distributed by:

JAMECO[®]
ELECTRONICS

www.Jameco.com ♦ 1-800-831-4242

The content and copyrights of the attached
material are the property of its owner.

Jameco Part Number 495429

Circular Plastic Connectors, Series 2

**CPC Connectors, Series 2
for Cable or Panel Mount**

(Accepts Size 20 DM or DF Crimp,
Snap-In Contacts)

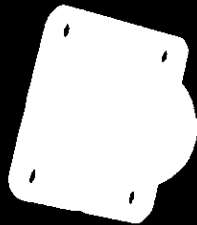

Square Flange Receptacle

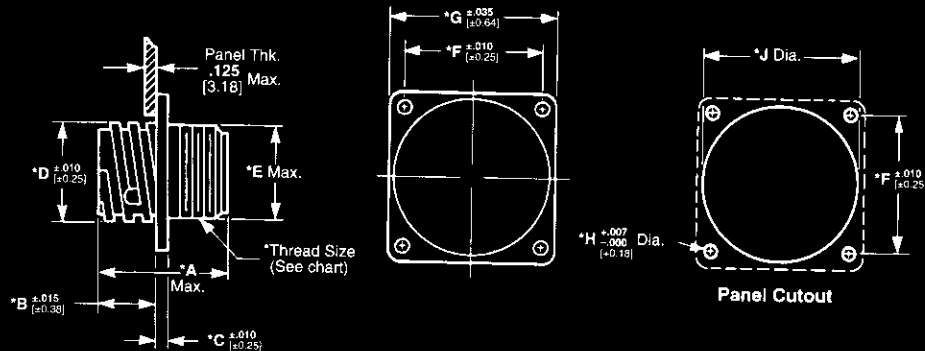

Free-Hanging Receptacle

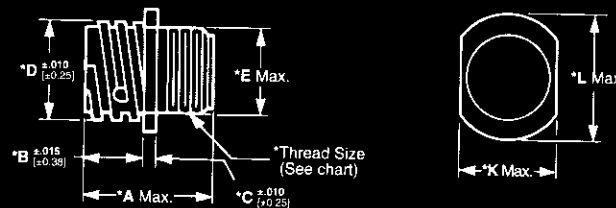

*Note:
See page 31 for callout dimensions

Listed part numbers are for
connectors only; **contacts must
be ordered separately.**

Material

Housing—Thermoplastic, 94V-0 rated,
black

Related Product Data

- Contacts**—Pages 28-29
- Contact Arrangement**—Page 30
- Component Dimensions**—Page 31*
- Accessories**—Pages 37-41
- Performance Characteristics**—
Page 6
- Application Tooling**—Pages 75-78
- Technical Documents**—Page 79

Plug

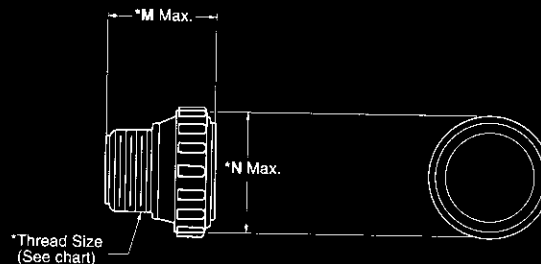

Standard Sex Connectors

(Receptacles accept Size 20 DM or DF pin contacts, Plugs accept Size 20 DM or DF socket contacts)

Arrangement	Square Flange Receptacle		Free-Hanging Receptacle	Plug
	With Mounting Holes	With Threaded Inserts ¹		
11-8	205841-1	205841-3	205841-2	205838-1
11-9	206486-1	206852-8	206486-2	206485-1
17-28	205840-3	205840-4	206152-1	205839-3
23-63	205843-1	—	205843-2	205842-1

¹Four 4-40 threaded inserts per receptacle.

Reverse Sex Connectors

(Receptacles accept Size 20 DM or DF socket contacts, Plugs accept Size 20 DM or DF pin contacts)

Arrangement	Square Flange Receptacle		Free-Hanging Receptacle	Plug
	With Mounting Holes	With Threaded Inserts ¹		
11-8	206433-1	206433-3	206433-2	206434-1
17-28	206038-1	206038-4	206038-2	206039-1
23-57	206438-1	—	206438-2	206437-1

¹Four 4-40 threaded inserts per receptacle.

Note: For Standard and Reverse Sex Connectors the maximum wire insulation diameter is .068 [1.73].

Replacement Coupling Rings

Shell Size	Part No.
11	213811-1
17	213810-1
23	213812-1