

Distributed by:

JAMECO[®]
ELECTRONICS

www.Jameco.com ♦ 1-800-831-4242

The content and copyrights of the attached
material are the property of its owner.

Jameco Part Number 67821

MATERIALS

1. CONTACT: BRASS
2. INSULATOR: PBT (UL 94V-0)
3. CONTACT PLATING: GOLD OVER NICKEL

SPECIFICATION

1. INSULATOR RESISTANCE: 5000M ohms Min
2. CURRENT RATING: 3 Amps
3. DIELECTRIC WITHSTANDING VOLTAGE: AC 500V
4. OPERATING TEMPERATURE: -45°C TO +105°C

Old Series number : 7000-2xXX-SG

Part Number :

2012-254-2xXX-SG

XX : number of contacts

ROHS

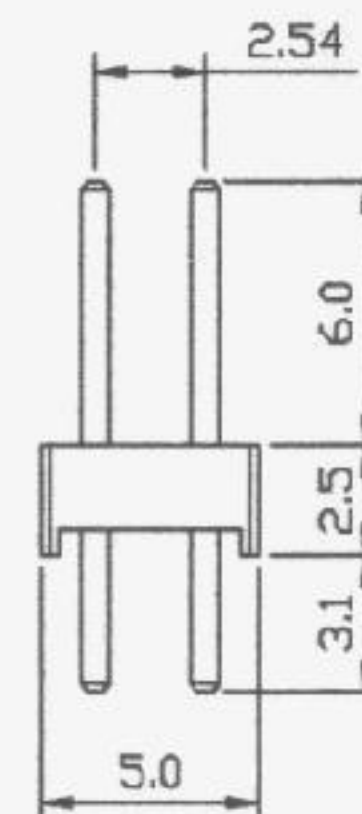
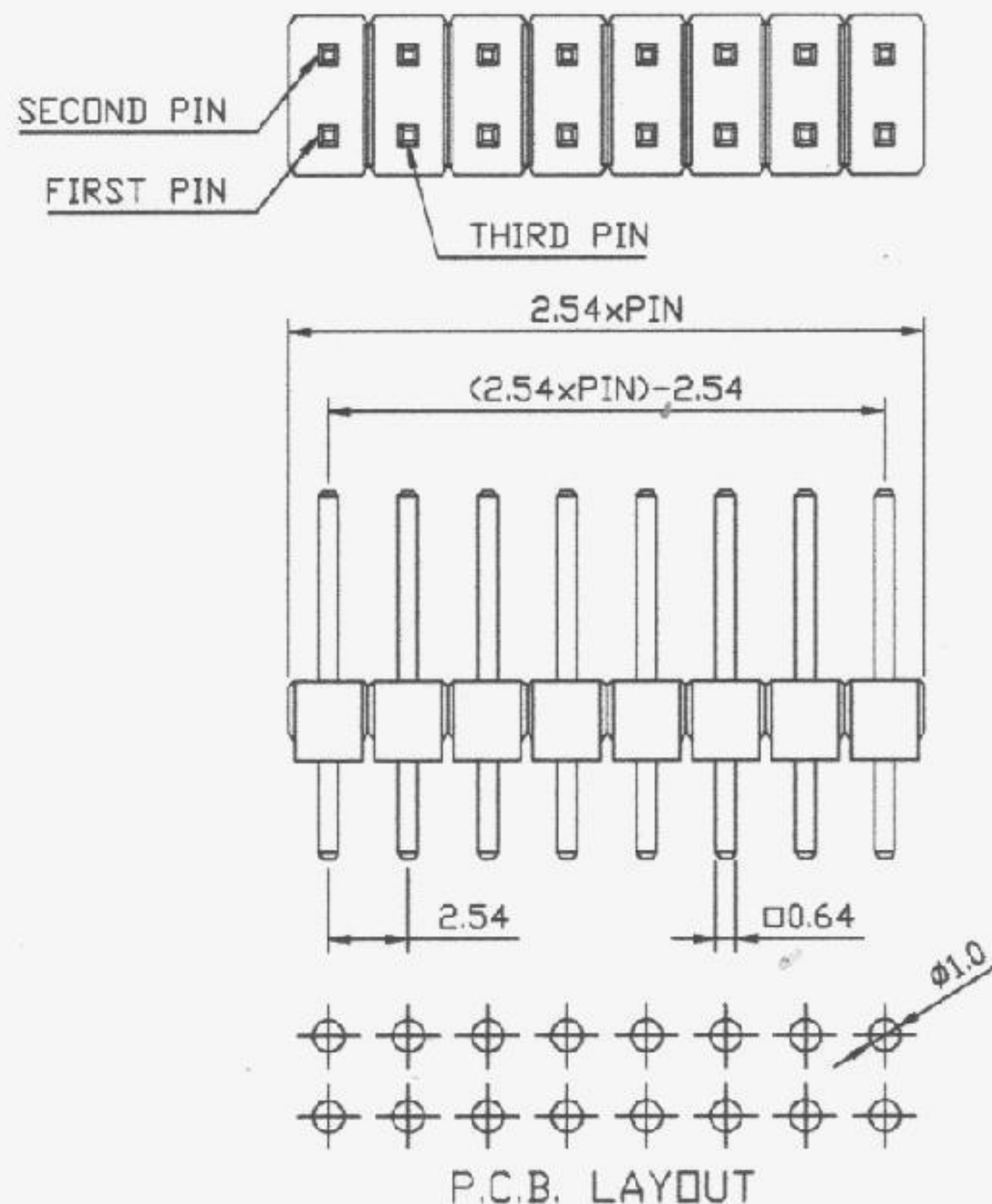

TOP WILLING

TITLE	PIN HEADER PITCH=2.54mm STRAIGHT 雙排	SCALE	APP.	GENERAL TOLERANCE UNLESS SPECIFIED			
		SHEET	1 OF 1	CHK.	JACKY	LINEAR	0.0±0.30
DWG.NO.	P3-01IXXX116S1BG	UNIT	MM	DR.	DAVID	0.00±0.20	
						ANGLES	±1°



REV