

Distributed by:

JAMECO[®]
ELECTRONICS

www.Jameco.com ♦ 1-800-831-4242

The content and copyrights of the attached
material are the property of its owner.

Jameco Part Number 69404

Dimensions in mm

MFA

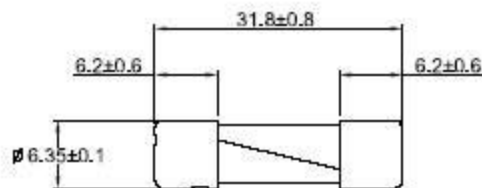

MFA-PA

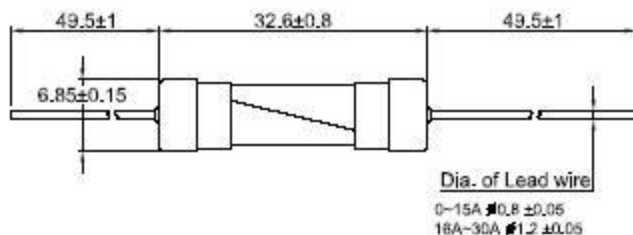

* PS:12A~25A 32V approvals
30A 32V approvals

Test Specification according to standard
UL 248-1,14

Electrical Characteristic

Rated Current	1.0In	1.35In	2.0In
In	Min.	Max.	Max.
100mA-30A	4 h	3600 s	120 s

MFA-P

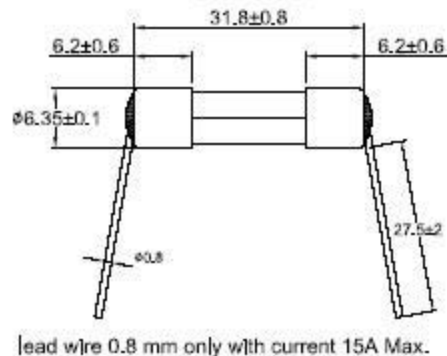

MFA-PR

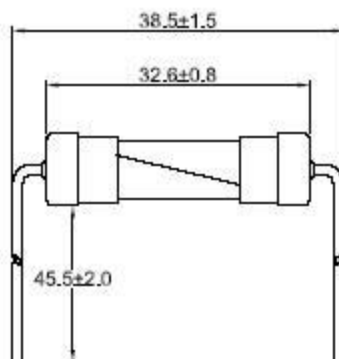

Rated Current	Breaking capacity	Rated Voltage	MFA-P/PR/PA			
100mA	@125V/AC 10KA @250V/AC 35A	125V/250V				
125mA		125V/250V				
150mA		125V/250V				
200mA		125V/250V				
250mA		125V/250V				
300mA		125V/250V				
315mA		125V/250V				
400mA		125V/250V				
500mA		125V/250V				
600mA		125V/250V				
800mA		125V/250V				
1A		125V/250V				
1.25A		@125V/AC 10KA @250V/AC 100A	125V/250V			
1.5A			125V/250V			
1.8A			125V/250V			
2A	125V/250V					
2.5A	125V/250V					
3A	125V/250V					
3.15A	125V/250V					
3.5A	125V/250V					
4A	125V/250V					
5A	125V/250V					
5A	@125V/AC 10KA @250V/AC 200A	125V/250V				
5.3A		125V/250V				
7A		125V/250V				
8A		125V/250V				
10A		125V/250V				
* 12A		@32V/AC 1000A	32V			
* 13A			32V			
* 15A			32V			
* 16A			32V			
* 20A			32V			
* 25A	32V					
* 30A	32V					

UNLESS OTHERWISE SPECIFIED DIMENSIONS ARE IN MM TOLERANCE DECIMALS ANGULAR X ± 0.5 ± 2° XX ± 0.25 DO NOT SCALE DRAWING	CUSTOMER NO.	TITLE Miniature Cartridge Fuse6.35x32mm
	DRAWN BY JANE	
	CHECKED BY	
	APPROVED BY	
	DATE 2008.06.16	PART NO. MFA MFA- P/PA /PR
P/N MFA63ax.xxx	SCALE	DRAWING NO. AA05062109