

Distributed by:



www.Jameco.com ♦ 1-800-831-4242

The content and copyrights of the attached material are the property of its owner.

Jameco Part Number 696984

SERIES 78 SPST To 4PST Slide

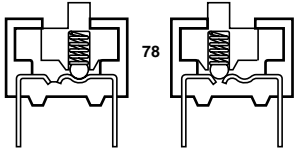

- ### FEATURES
- Raised and Recessed Slides
 - SPST, 2PST, 3PST, 4PST
 - Sealed Base Standard
 - Spring and Ball Contact
 - Top Tape Seal Option



DIMENSIONS In inches (and millimeters)

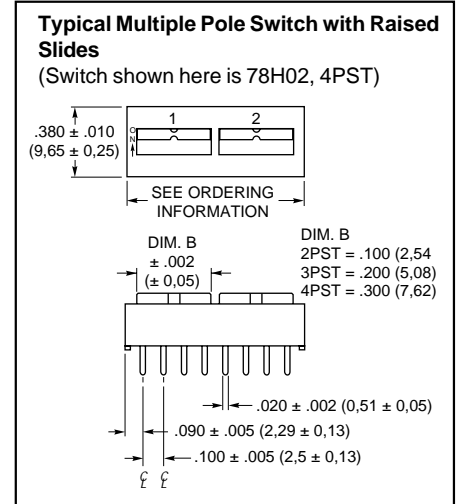
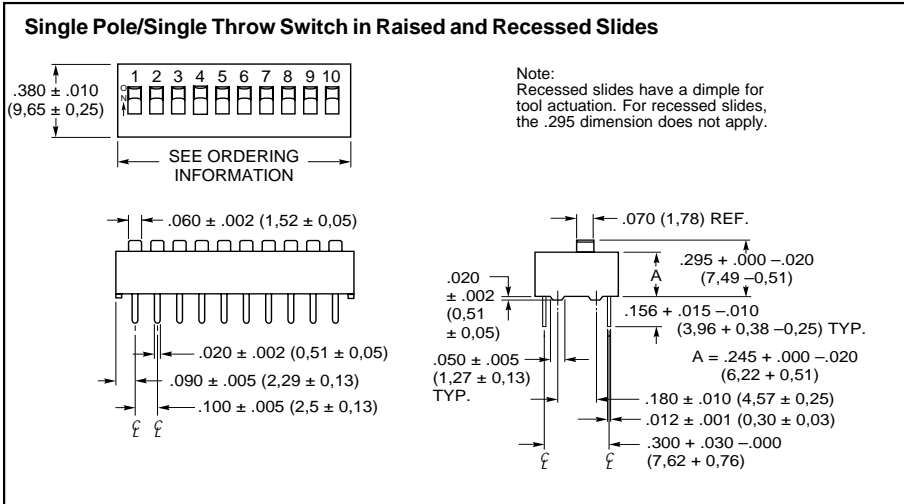

CIRCUITRY

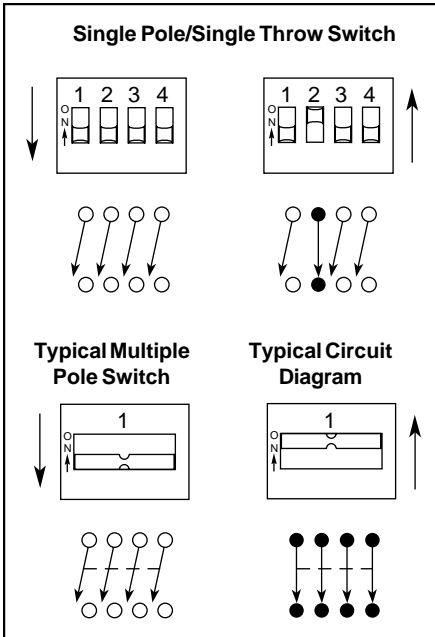

For switches with 5, 6, 7, 8, or 10PST circuitry, contact Grayhill.

*A top tape seal is required for switches that are machine soldered or heavily cleaned after hand soldering. To order top seal versions, add "S" to the Grayhill part number.

ORDERING INFORMATION

Circuitry	No. of Positions	Length Inches	Length Metric	No./ Tube	Raised Slides*	Recessed Slides*	
SPST	2	0.280"	7,1mm	35	78B02	78RB02	
	3	0.380"	9,7mm	27	78B03	78RB03	
	4	0.480"	12,2mm	21	78B04	78RB04	
	5	0.580"	14,7mm	18	78B05	78RB05	
	6	0.680"	17,3mm	15	78B06	78RB06	
	7	0.780"	19,8mm	13	78B07	78RB07	
	8	0.880"	22,4mm	12	78B08	78RB08	
	9	0.980"	24,9mm	10	78B09	78RB09	
	10	1.080"	27,4mm	9	78B10	78RB10	
	12	1.280"	32,5mm	8	78B12	78RB12	
	2PST	1	0.280"	7,1mm	35	78F01	Recessed Slides Not Available
		2	0.480"	12,2mm	21	78F02	
3		0.680"	17,3mm	15	78F03		
4		0.880"	22,4mm	12	78F04		
5		1.080"	27,4mm	9	78F05		
6		1.280"	32,5mm	8	78F06		
3PST	1	0.380"	9,7mm	27	78G01	Recessed Slides Not Available	
	2	0.680"	17,3mm	15	78G02		
	3	0.980"	24,9mm	10	78G03		
4PST	1	0.480"	12,2mm	21	78H01	Recessed Slides Not Available	
	2	0.880"	22,4mm	12	78H02		

ADDITIONAL INFORMATION

For Specifications see page B-14.
For other Options and Accessories, see page B-20.

Available from your local Grayhill Distributor.
For prices and discounts, contact a local Sales Office, an authorized local Distributor or Grayhill.