

Distributed by:

**JAMECO**<sup>®</sup>  
ELECTRONICS

**www.Jameco.com ♦ 1-800-831-4242**

The content and copyrights of the attached  
material are the property of its owner.

Jameco Part Number 736801



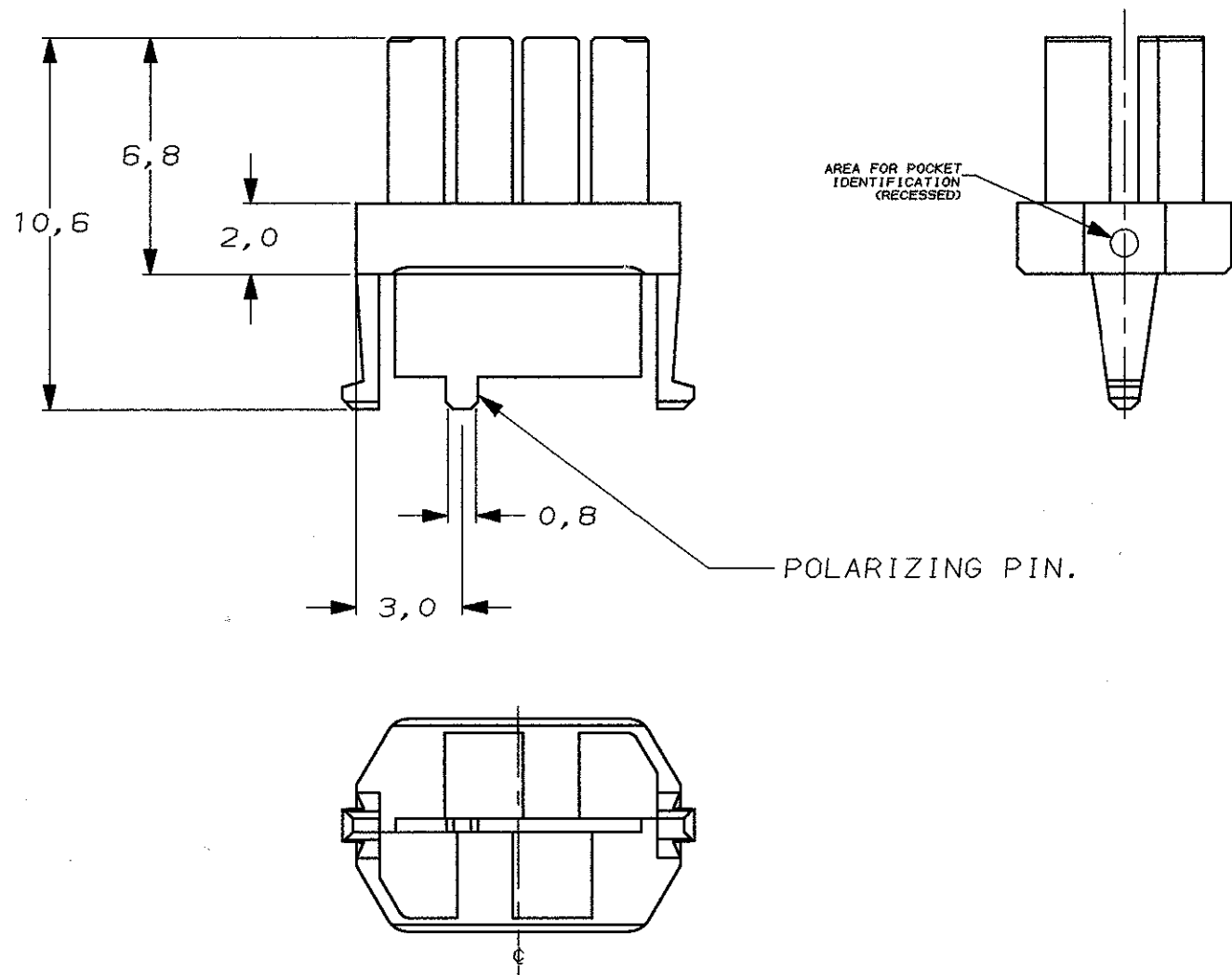
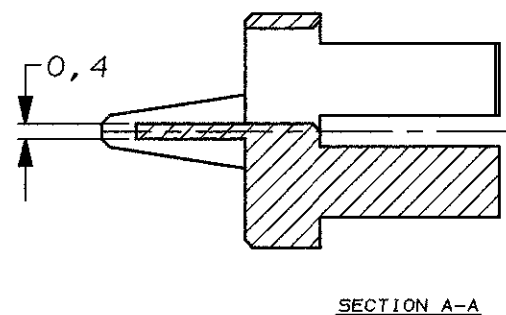
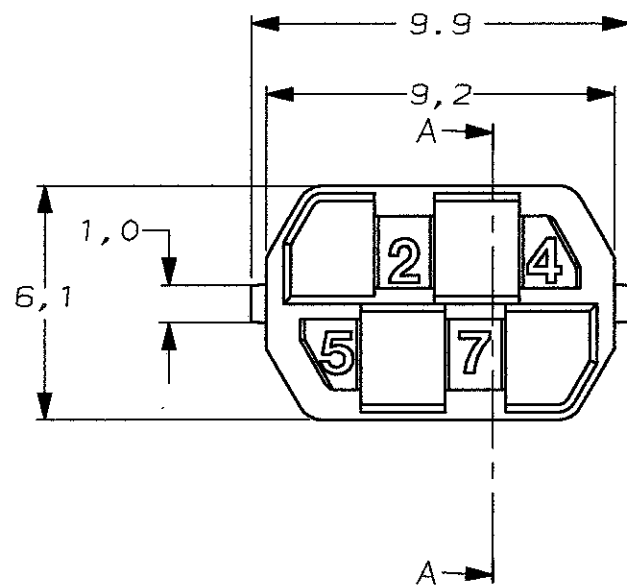

DO NOT SCALE  
DIMENSIONS IN mm

METRIC

THIRD ANGLE  
PROJECTION

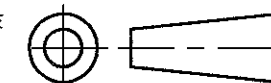

MALE KEY	COLOUR	RAL NR.	ID. NUMBER	PARTNUMBER
-	-	-	-	-
-	-	-	-	-
-	-	-	-	-
-	-	-	-	-
-	-	-	-	-
-	-	-	-	-
-	-	-	-	-
-	-	-	-	-
-	-	-	-	-
6-100525-9	OCHEK YELLOW	1024	1235	6-100526-9
6-100525-4	RASPBERRY RED	3027	1246	6-100526-4
5-100525-3	OCEAN BLUE	5020	1347	5-100526-3
5-100525-2	EMERALD GREEN	6001	1348	5-100526-2
4-100525-9	YELLOW ORANGE	2000	1358	4-100526-9
4-100525-8	HEATHER VIOLET	4003	1367	4-100526-8
4-100525-4	COPPER BROWN	8004	1457	4-100526-4
4-100525-3	STONE GREY	7030	1458	4-100526-3
3-100525-7	PURPLE RED	3004	1578	3-100526-7
3-100525-5	SALMON PINK	3022	2345	3-100526-5
3-100525-4	RED LILAC	4001	2346	3-100526-4
2-100525-7	LIGHT IVORY	1015	2368	2-100526-7
2-100525-6	PASTEL GREEN	6019	2378	2-100526-6
2-100525-4	YELLOW GREEN	6018	2457	2-100526-4
2-100525-0	BLUE LILAC	4005	2478	2-100526-0
1-100525-8	PIGEON BLUE	5014	2568	1-100526-8
1-100525-4	OLIVE YELLOW	1020	3457	1-100526-4
1-100525-3	CEMENT GREY	7033	3458	1-100526-3
1-100525-2	LIGHT GREEN	6027	3467	1-100526-2
100525-8	PURE ORANGE	2004	3568	100526-8
100525-5	ULTRAMARINE BLUE	5002	4567	100526-5
100525-2	GREEN BROWN	8000	4678	100526-2

**CUSTOMER DRAWING** FOR REFERENCE ONLY WILL NOT BE UPDATED

© COPYRIGHT 1996 BY AMP HOLLAND B.V.  
ALL INTERNATIONAL RIGHTS RESERVED. AMP PRODUCTS MAY BE COVERED BY U.S. AND FOREIGN AND/OR PATENTS PENDING.  
THIS DRAWING IS UNPUBLISHED  
RELEASED FOR PUBLICATION \_\_\_\_\_, 19\_\_\_\_

**AMP** | AMP HOLLAND B.V.  
s-Hertogenbosch,  
The Netherlands.

NAME: Z-PACK 2mm HM  
FEMALE CODING KEYS

LTR.	REVISION RECORD	DR.	CHK.	DATE
DR.:	D. TRUREN	CHK.:	D. TRUREN	APP.:
DATE:	03-FEB-98	DATE:	03-FEB-98	F.v. KONINGSBRUGGE

DWG. No. C-100526  
REV. LTR. D  
SHEET 2 OF 2  
A3