

Distributed by:

**JAMECO**<sup>®</sup>  
ELECTRONICS

**www.Jameco.com ♦ 1-800-831-4242**

The content and copyrights of the attached  
material are the property of its owner.

Jameco Part Number 769936

\*RoHS COMPLIANT

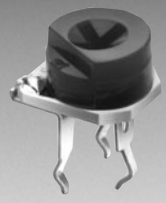

**BOURNS®**

**Features**

- 6 mm Round / Single-Turn / Cermet Industrial / Open Frame
- Cross slot adjustment options
- Horizontal and vertical mounting styles
- Dust resistant/splash resistant covers
- PC board stand-offs and retention feature
- Front and top adjust styles
- RoHS compliant\*

**3306 - 6 mm Round Trimming Potentiometer**

**Electrical Characteristics**

Standard Resistance Range .....100 ohms to 1 megohm (see standard resistance table)  
 Resistance Tolerance .....±25 % std. (tighter tolerance available)  
 Absolute Minimum Resistance .....2 % max. (≤2K = 30 ohms)  
 Contact Resistance Variation .3 % max.  
 Resolution.....Essentially infinite  
 Adjustment Angle .....215 ° nom.

**Environmental Characteristics**

Power Rating (100 volts max.)  
 70 °C .....0.2 watt  
 Temperature Range .....-25 °C to +100 °C  
 Temperature Coefficient .....±250 ppm/°C  
 Load Life...1,000 hours 0.2 watt @ 70 °C (5 % ΔTR)

**Physical Characteristics**

Mechanical Angle.....260 ° ±20 °  
 Torque (Operating).....4.5 oz-in. max.  
 Stop Strength.....6.5 oz -in. min.  
 Terminals .....Solderable pins  
 Marking .....Manufacturer's trademark, resistance code  
 Standard Packaging .....300 pcs. per bag  
 Adjustment Tool .....H-90  
 Aqueous cleaning not recommended

**How To Order**

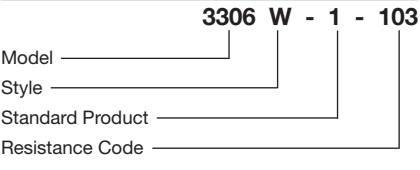

**Standard Resistance Table**

Resistance (Ohms)	Resistance Code
<b>100</b>	<b>101</b>
<b>200</b>	<b>201</b>
<b>500</b>	<b>501</b>
<b>1,000</b>	<b>102</b>
<b>2,000</b>	<b>202</b>
<b>5,000</b>	<b>502</b>
<b>10,000</b>	<b>103</b>
<b>20,000</b>	<b>203</b>
<b>25,000</b>	<b>253</b>
<b>50,000</b>	<b>503</b>
<b>100,000</b>	<b>104</b>
200,000	204
250,000	254
500,000	504
1,000,000	105

Popular distribution resistance values listed in boldface.

**Top Adjust Common Dimensions**

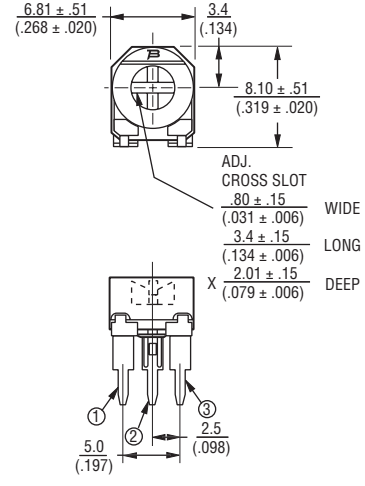

**Side Adjust Common Dimensions**

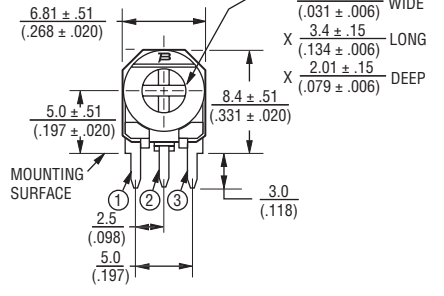

**3306W**

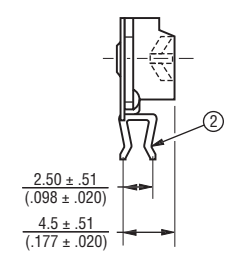

**3306K**

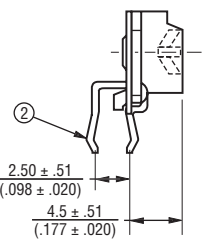

**3306P**

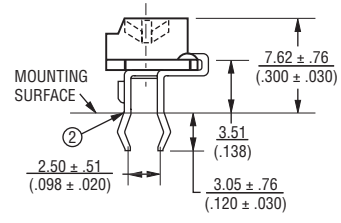

**3306F**

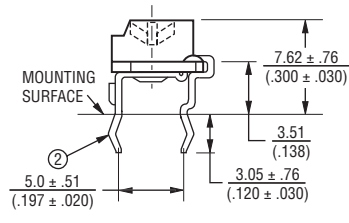

**SUGGESTED PWB LAYOUT - STYLES K, P, W**

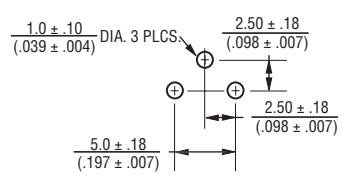

**SUGGESTED PWB LAYOUT - STYLE F**

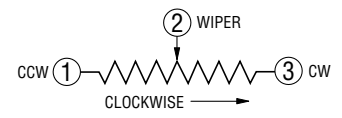
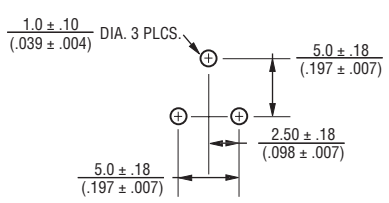

TOLERANCES: ± 0.25 (.010) EXCEPT WHERE NOTED

DIMENSIONS ARE:  $\frac{MM}{(INCHES)}$

\*RoHS Directive 2002/95/EC Jan 27 2003 including Annex. Specifications are subject to change without notice. Customers should verify actual device performance in their specific applications.