

## Features

- Single Turn / Cermet / Industrial / Sealed
- Available on tape and reel
- Available with a knob for finger adjust
- Available with extended shaft
- Available with cross-slot rotor
- Top and side adjust types (F, P, H, W, X most popular)
- RoHS compliant\* version available
- For trimmer applications/processing guidelines, [click here](#)

## 3386 - 3/8" Square Trimpot® Trimming Potentiometer

### Electrical Characteristics

Standard Resistance Range ..... 10 ohms to 2 megohms  
 (see standard resistance table)  
 Resistance Tolerance ..... ±10 % std.  
 (tighter tolerance available)  
 Absolute Minimum Resistance ..... 2 ohms max.  
 Contact Resistance Variation ..... 2 % or 3 ohms max.  
 (whichever is greater)  
 Adjustability  
 Voltage Divider ..... ±0.05 %  
 Rheostat ..... ±0.15 %  
 Resolution ..... Infinite  
 Insulation Resistance ..... 500 vdc.  
 1,000 megohms min.  
 Dielectric Strength  
 Sea Level ..... 900 vac  
 70,000 Feet ..... 350 vac  
 Adjustment Angle ..... 280 ° nom.

### Environmental Characteristics

Power Rating (300 volts max.)  
 85 °C ..... 0.5 watt  
 125 °C ..... 0 watt  
 Temperature Range ... -55 °C to +125 °C  
 Temperature Coefficient ... ±100 ppm/°C  
 Seal Test ..... 85 °C Fluorinert†  
 Humidity ..... MIL-STD-202 Method 103  
 96 hours  
 (2 % ΔTR, 10 Megohms min.)  
 Vibration ..... 30 G (1 % ΔTR; 1 % ΔVR)  
 Shock ..... 100 G (1 % ΔTR; 1 % ΔVR)  
 Load Life.. 1,000 hours 0.5 watt @ 70 °C  
 (3 % ΔTR; 3 % or 3 ohms,  
 whichever is greater, CRV)  
 Rotational Life ..... 200 cycles  
 (4 % ΔTR; 3 % or 3 ohms,  
 whichever is greater, CRV)

### Physical Characteristics

Mechanical Angle ..... 310 ° nom.  
 Torque ..... 5.0 oz-in. max.  
 Stop Strength ..... 15.0 oz-in. min.  
 Terminals ..... Solderable pins  
 Weight ..... 0.03 oz.  
 Marking ..... Manufacturer's  
 trademark, resistance code,  
 wiring diagram, date code,  
 manufacturer's model  
 number and style  
 Flammability ..... U.L. 94V-0  
 Standard Packaging ..... 50 pcs. per tube  
 Wiper ..... 50 % (Actual TR) ±10 %  
 Adjustment Tool ..... H-90

\*RoHS Directive 2002/95/EC Jan. 27, 2003 including annex and RoHS Recast 2011/65/EU June 8, 2011.  
 †"Fluorinert" is a registered trademark of 3M Co.  
 Specifications are subject to change without notice.  
 The device characteristics and parameters in this data sheet can and do vary in different applications and actual device performance may vary over time.  
 Users should verify actual device performance in their specific applications.

### Product Dimensions

#### Common Dimensions

#### Side Adjust Models B,C,J,X

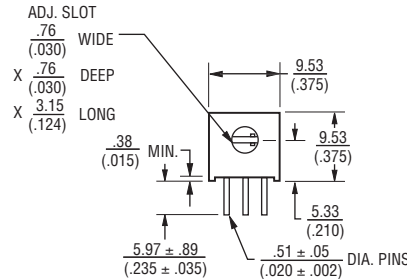

3386B

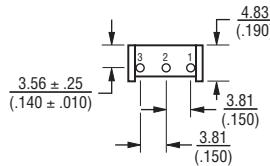

3386C

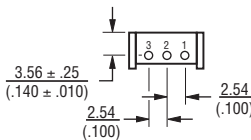

3386J

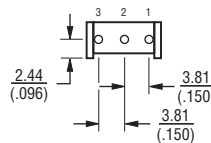

3386X

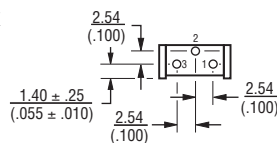

#### Common Dimensions

#### Side Adjust Models H,S,W

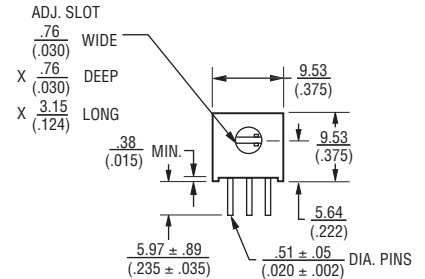

3386H

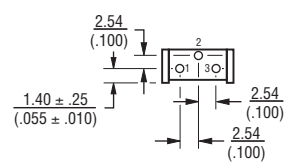

3386S

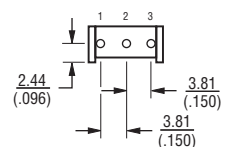

3386W

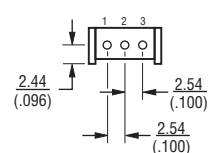

DIMENSIONS:  $\frac{\text{MM}}{\text{(INCHES)}}$

TOLERANCES: ±  $\frac{0.25}{(.010)}$  EXCEPT WHERE NOTED

### Standard Resistance Table

Resistance (Ohms)	Resistance Code
10	100
20	200
50	500
100	101
200	201
500	501
1,000	102
2,000	202
5,000	502
10,000	103
20,000	203
25,000	253
50,000	503
100,000	104
200,000	204
250,000	254
500,000	504
1,000,000	105
2,000,000	205

Popular distribution resistance values listed in boldface. Special resistances available.

### How To Order

**3386 P - 1 - 103 T LF**

Model \_\_\_\_\_  
 Style \_\_\_\_\_  
 Standard or Modified \_\_\_\_\_  
 Product Indicator \_\_\_\_\_  
 -1 = Standard Product  
 -EY5 = Extended Shaft  
 Resistance Code \_\_\_\_\_  
 Optional Suffix Letter \_\_\_\_\_  
 T = Knob\*\*  
 Packaging Designator \_\_\_\_\_  
 Blank = Tube (Standard)  
 R = Tape & Reel (W and U Pin Styles Only)  
 A = Ammo Pack (W and U Pin Styles Only)

Terminations \_\_\_\_\_  
 LF = 100 % Tin-plated (RoHS compliant)  
 Blank = 90 % Tin / 10 % Lead-plated (Standard)

\*\*Knob option is available only in standard tube packaging. Not recommended for side load applications.

Consult factory for other available options.

# 3386 - 3/8" Square Trimpot® Trimming Potentiometer

# BOURNS®

## Product Dimensions

### Common Dimensions Top Adjust Models F,G,K,P,R,U,V,Y

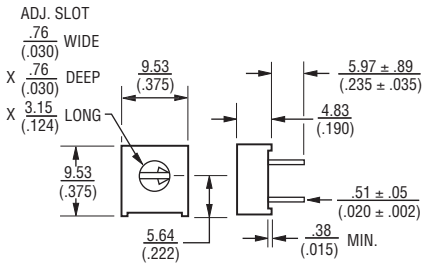

### 3386F



### 3386G

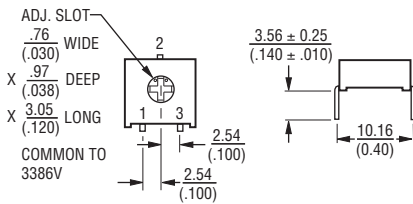

### 3386K

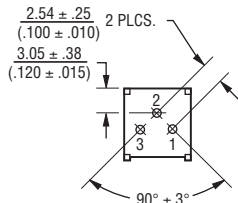

### 3386P

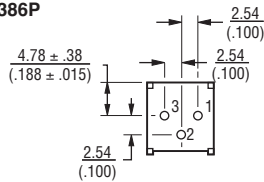

### 3386R



### 3386U

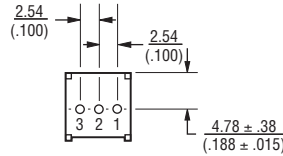

### 3386V

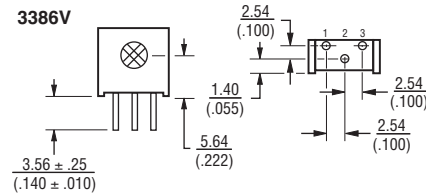

### 3386Y

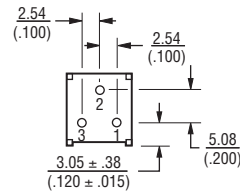

### Common Dimensions Top Adjust Models M,T

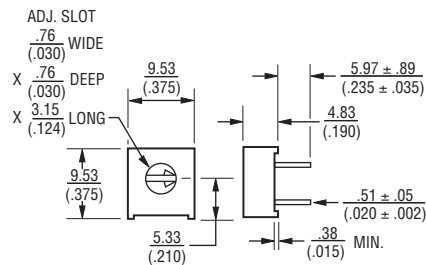

### 3386M

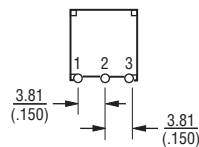

### 3386T

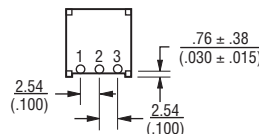

### 3386H-EY5 3386X-EY5 – SHOWN

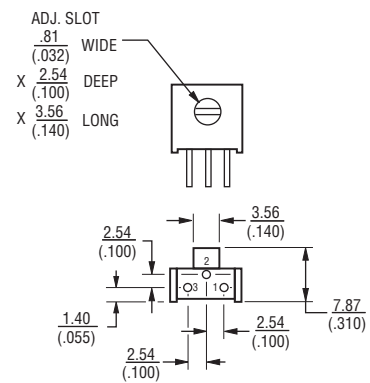

### 3386P-EY5

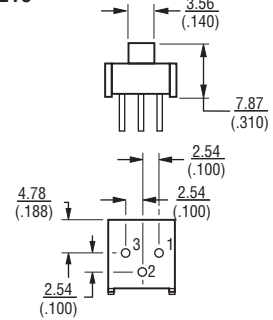

The Model 3386 is available with a knob for finger adjustment. Add suffix letter "T" to order code for F, P and X terminal styles.

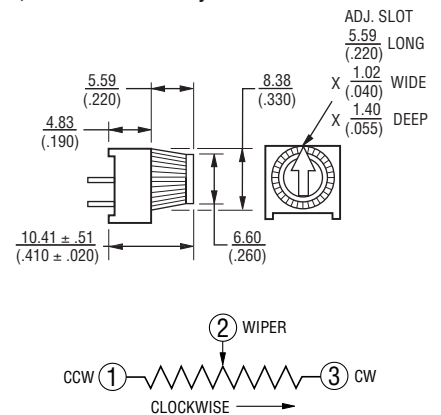

DIMENSIONS:  $\frac{\text{MM}}{\text{(INCHES)}}$   
TOLERANCES:  $\pm \frac{0.25}{(.010)}$  EXCEPT WHERE NOTED

Specifications are subject to change without notice. The device characteristics and parameters in this data sheet can and do vary in different applications and actual device performance may vary over time. Users should verify actual device performance in their specific applications.

# 3386 - 3/8 " Square Trimpot® Trimming Potentiometer

**BOURNS®**

## Packaging Specifications

**SIDE ADJUST**  
**3386W-1**

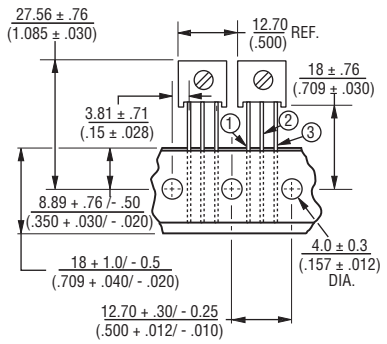

ALL PINS IN-LINE ON  $\frac{2.54}{(.100)}$  CENTER  
DIMENSIONS:  $\frac{\text{MM}}{\text{(INCHES)}}$   
1000/REEL/BOX

**TOP ADJUST**  
**3386U-1**

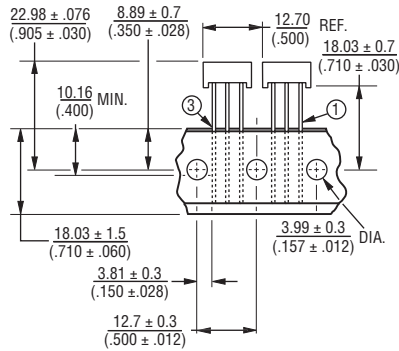

ALL PINS IN-LINE ON  $\frac{2.54}{(.100)}$  CENTER  
DIMENSIONS:  $\frac{\text{MM}}{\text{(INCHES)}}$   
1000/REEL/BOX

Meets EIA Specification 468.

DIMENSIONS:  $\frac{\text{MM}}{\text{(INCHES)}}$

REV. 09/13

"Trimpot" is a registered trademark of Bourns, Inc.  
Specifications are subject to change without notice.

The device characteristics and parameters in this data sheet can and do vary in different applications and actual device performance may vary over time. Users should verify actual device performance in their specific applications.