

Distributed by:

JAMECO[®]
ELECTRONICS

www.Jameco.com ♦ 1-800-831-4242

The content and copyrights of the attached
material are the property of its owner.

Jameco Part Number 795051

STANDARD RING TONGUE

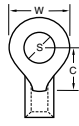

Material: Copper

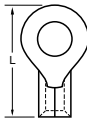

Krimptite®

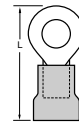

Insulkrimp®
(PVC Insulation)

Wire Range AWG (mm ²)	Stud Size S	Maximum Width W	Minimum Clearance C	Loose Piece Order No.	Mylar Tape Order No.	Maximum Length L	Loose Piece Order No.	Mylar Tape Order No.	Maximum Length L
10-12 (5.00-3.30)	5-6 (3-3.5)	7.40 (.292)	7.80 (.306)	19069-0230	19069-0232	18.80 (.741)	19070-0143	19070-0144	26.20 (1.032)
		9.80 (.385)	7.70 (.303)	19069-0202		19.90 (.785)	19070-0119	19070-0120	27.30 (1.076)
	8 (4)	7.40 (.292)	7.80 (.306)	19069-0233	19069-0235	18.80 (.741)	19070-0145	19070-0146	26.20 (1.032)
		9.80 (.385)	7.70 (.303)	19069-0205	19069-0208	19.90 (.785)	19070-0121	19070-0122	27.30 (1.076)
	10 (-)	9.80 (.385)	7.70 (.303)	19069-0209	19069-0212	19.90 (.785)	19070-0123	19070-0125	27.30 (1.076)
		13.70 (.540)	10.00 (.393)	19069-0217	19069-0218	24.20 (.952)	19070-0130	19070-0131	31.60 (1.243)
		15.20 (.598)	14.40 (.566)	19069-0236		26.80 (1.056)			
	1/4 (6)	13.70 (.540)	10.00 (.393)	19069-0219	19069-0221	24.20 (.952)	19070-0132	19070-0133	31.60 (1.243)
		15.20 (.598)	14.40 (.566)	19069-0238	19069-0240	26.80 (1.056)	19070-0150	19070-0151	34.20 (1.347)
	5/16 (8)	13.70 (.540)	10.00 (.393)	19069-0223	19069-0225	24.20 (.952)	19070-0136	19070-0137	31.60 (1.243)
		15.20 (.598)	14.40 (.566)	19069-0244	19069-0246	26.80 (1.056)	19070-0155	19070-0156	34.20 (1.347)
	3/8 (9)	15.20 (.598)	14.40 (.566)	19069-0241	19069-0243	26.80 (1.056)	19070-0153	19070-0154	34.20 (1.347)
		19.30 (.760)	15.50 (.611)	19069-0196	19069-0145	32.50 (1.280)			39.90 (1.571)
	7/16 (11)	19.30 (.760)	15.50 (.611)	19069-0198	19069-0146	32.50 (1.280)	19070-0115	19070-0116	39.90 (1.571)
	1/2 (12)	19.30 (.760)	15.50 (.611)	19069-0192	19069-0194	32.50 (1.280)	19070-0109	19070-0110	39.90 (1.571)

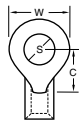

Material: Copper



Versakrimp™

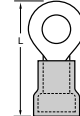

Avikrimp®
(Nylon Insulation)

Wire Range AWG (mm ²)	Stud Size S	Maximum Width W	Minimum Clearance C	Loose Piece Order No.	Mylar Tape Order No.	Maximum Length L	Loose Piece Order No.	Mylar Tape Order No.	Expanded Flare Order No.*	Expanded Flare on Mylar Tape Order No.*	Maximum Length L
10-12 (5.00-3.30)	5-6 (3-3.5)	7.40 (.292)	7.80 (.306)	19193-0128	19193-0129	18.80 (.741)	19073-0216	19073-0218	19073-0220	19073-0221	27.00 (1.047)
		9.80 (.385)	7.70 (.303)	19193-0103	19193-0105	19.90 (.785)	19073-0160	19073-0162	19073-0163	19073-0164	27.70 (1.091)
	8 (4)	7.40 (.292)	7.80 (.306)	19193-0130	19193-0131	18.80 (.741)	19073-0222	19073-0224	19073-0225	19073-0226	27.00 (1.047)
		9.80 (.385)	7.70 (.303)	19193-0106	19193-0108	19.90 (.785)	19073-0165	19073-0167	19073-0168	19073-0169	27.70 (1.091)
	10 (-)	9.80 (.385)	7.70 (.303)	19193-0109	19193-0111	19.90 (.785)	19073-0170	19073-0172	19073-0173	19073-0174	27.70 (1.091)
		13.70 (.540)	10.00 (.393)	19193-0114	19193-0115	24.20 (.952)	19073-0179	19073-0180	19073-0181	19073-0184	32.00 (1.258)
		15.20 (.598)	14.40 (.566)				19073-0227	19073-0228	19073-0229	19073-0230	34.60 (1.362)
	1/4 (6)	13.70 (.540)	10.00 (.393)	19193-0116	19193-0118	24.20 (.952)	19073-0188	19073-0190	19073-0191	19073-0194	32.00 (1.258)
		15.20 (.598)	14.40 (.566)	19193-0134	19193-0135	26.80 (1.056)	19073-0231	19073-0232	19073-0233	19073-0234	34.60 (1.362)
	5/16 (8)	13.70 (.540)	10.00 (.393)	19193-0120	19193-0122	24.20 (.952)	19073-0200	19073-0201	19073-0202	19073-0205	32.00 (1.258)
		15.20 (.598)	14.40 (.566)	19193-0141	19193-0142	26.80 (1.056)	19073-0242	19073-0243	19073-0244	19073-0245	34.60 (1.362)
	3/8 (9)	15.20 (.598)	14.40 (.566)	19193-0137	19193-0139	26.80 (1.056)	19073-0236	19073-0237	19073-0238	19073-0239	34.60 (1.362)
		19.30 (.760)	15.50 (.611)	19193-0097		32.50 (1.280)					
	7/16 (11)	19.30 (.760)	15.50 (.611)	19193-0099	19193-0100	32.50 (1.280)					
	1/2 (12)	19.30 (.760)	15.50 (.611)	19193-0094	19193-0095	32.50 (1.280)	19073-0145	19073-0146	19073-0147		40.30 (1.586)

* For use with heavier wire insulation. Maximum wire insulation (.255") 6.50mm.

MATERIAL NO. LOOSE PIECE	ENG. NO.	MATERIAL NO. TAPE MOUNTED	ENG. NO.	STUD	±.003 "S"	STOCK THICKNESS
191930101	C-328-04	-----	-----	4	.126	.040 (1.02)
191930103	C-328-06	191930105	C-328-06T	6	.146	
191930106	C-328-08	191930108	C-328-08T	8	.173	
191930109	C-328-10	191930111	C-328-10T	10	.198	
191930112	C-328-209	191930113	C-328-209T	209	.209	

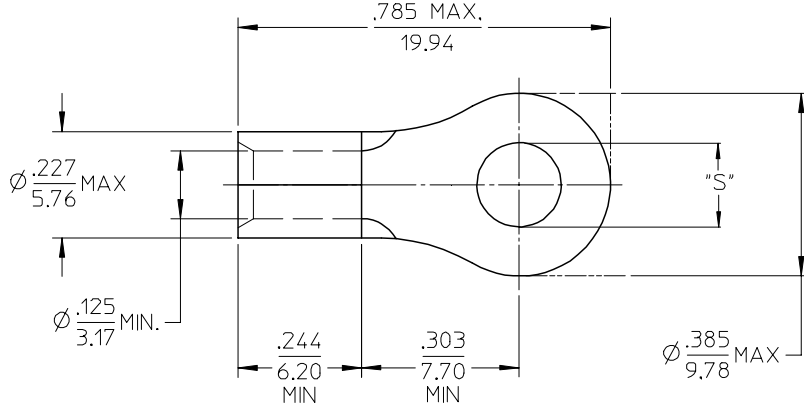
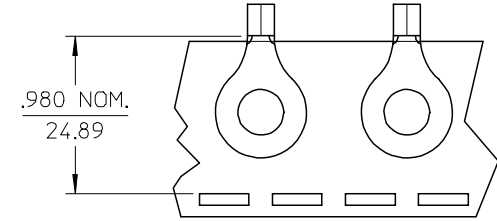

SALES DRAWING

NOTE(S):
 1. MATERIAL: COPPER
 2. PLATING: ELECTROPLATE TIN
 3. ALL DIMENSIONS IN INCHES/(MM)
 4. WIRE SIZE: 12-10 AWG
 4.0-6.0 MM²

REVISED/UPDATE TO MX STD EC NO: ETC2003-0315 DRWN:DMYRICK 2003/08/20 CHKD:HEB 2003/08/21 APPR:RDEROSS 2003/08/21	DESCRIPTION	QUALITY SYMBOLS	GENERAL TOLERANCES (UNLESS SPECIFIED)		SCALE 4:1	DESIGN UNITS INCH	THIRD ANGLE PROJECTION	REVISE ON CAD ONLY	
		REV	A	▼ = 0	mm	INCH	DIMENSION STYLE IN/MM		TITLE RING TONGUE TERMINAL VERSAKRIMP 12-10 AWG
				▽ = 0	4 PLACES ± --- ± ---	3 PLACES ± --- ± .005	DRAWN BY DLM	DATE 03/06/13	
					2 PLACES ± 0.13 ± .01	1 PLACE ± 0.25 ± ---	CHECKED BY HEB	DATE 03/06/13	MATERIAL NO. (SEE CHART)
	ANGULAR ± 1/2°	DRAFT WHERE APPLICABLE		APPROVED BY RWD	DATE 03/06/13	THIS DRAWING CONTAINS INFORMATION THAT IS PROPRIETARY TO MOLEX INCORPORATED AND SHOULD NOT BE USED WITHOUT WRITTEN PERMISSION			
		MUST REMAIN WITHIN DIMENSIONS							