

Distributed by:

JAMECO[®]
ELECTRONICS

www.Jameco.com ♦ 1-800-831-4242

The content and copyrights of the attached
material are the property of its owner.

Jameco Part Number 806952

D44VH10 (NPN), D45VH10 (PNP)

Complementary Silicon Power Transistors

These complementary silicon power transistors are designed for high-speed switching applications, such as switching regulators and high frequency inverters. The devices are also well-suited for drivers for high power switching circuits.

- Fast Switching –
 $t_f = 90$ ns (Max)
- Key Parameters Specified @ 100°C
- Low Collector–Emitter Saturation Voltage –
 $V_{CE(sat)} = 1.0$ V (Max) @ 8.0 A
- Complementary Pairs Simplify Circuit Designs
- Pb–Free Packages are Available*

MAXIMUM RATINGS

Rating	Symbol	Value	Unit
Collector–Emitter Voltage	V_{CEO}	80	Vdc
Collector–Emitter Voltage	V_{CEV}	100	Vdc
Emitter Base Voltage	V_{EB}	7.0	Vdc
Collector Current –Continuous	I_C	15	Adc
–Peak (Note 1)	I_{CM}	20	
Total Power Dissipation @ $T_C = 25^\circ\text{C}$ Derate above 25°C	P_D	83 0.67	W W/°C
Operating and Storage Junction Temperature Range	T_J, T_{stg}	–55 to 150	°C

THERMAL CHARACTERISTICS

Characteristic	Symbol	Max	Unit
Thermal Resistance, Junction to Case	$R_{\theta JC}$	1.5	°C/W
Thermal Resistance, Junction to Ambient	$R_{\theta JA}$	62.5	°C/W
Maximum Lead Temperature for Soldering Purposes: 1/8" from Case for 5 Seconds	T_L	275	°C

Maximum ratings are those values beyond which device damage can occur. Maximum ratings applied to the device are individual stress limit values (not normal operating conditions) and are not valid simultaneously. If these limits are exceeded, device functional operation is not implied, damage may occur and reliability may be affected.

1. Pulse Width ≤ 6.0 ms, Duty Cycle $\leq 50\%$.

*For additional information on our Pb–Free strategy and soldering details, please download the ON Semiconductor Soldering and Mounting Techniques Reference Manual, SOLDERRM/D.



ON Semiconductor®

<http://onsemi.com>

15 A COMPLEMENTARY SILICON POWER TRANSISTORS 80 V, 83 W

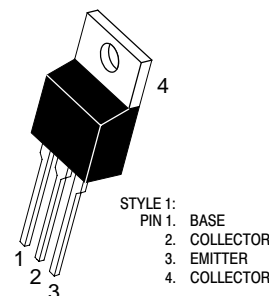

STYLE 1:
PIN 1. BASE
2. COLLECTOR
3. EMITTER
4. COLLECTOR

CASE 221A–09
TO–220AB

MARKING DIAGRAM

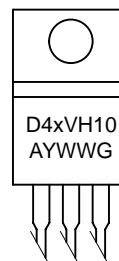

x = 4 or 5
A = Assembly Location
Y = Year
WW = Work Week
G = Pb–Free Package

ORDERING INFORMATION

Device	Package	Shipping
D44VH10	TO–220	50 Units/Rail
D44VH10G	TO–220 (Pb–Free)	50 Units/Rail
D45VH10	TO–220	50 Units/Rail
D45VH10G	TO–220 (Pb–Free)	50 Units/Rail

D44VH10 (NPN), D45VH10 (PNP)

ELECTRICAL CHARACTERISTICS ($T_C = 25^\circ\text{C}$ unless otherwise noted)

Characteristic	Symbol	Min	Typ	Max	Unit
----------------	--------	-----	-----	-----	------

OFF CHARACTERISTICS

Collector–Emitter Sustaining Voltage (Note 2) ($I_C = 25\text{ mA}$, $I_B = 0$)	$V_{CEO(sus)}$	80	–	–	Vdc
Collector–Emitter Cutoff Current ($V_{CE} = \text{Rated } V_{CEV}$, $V_{BE(off)} = 4.0\text{ Vdc}$) ($V_{CE} = \text{Rated } V_{CEV}$, $V_{BE(off)} = 4.0\text{ Vdc}$, $T_C = 100^\circ\text{C}$)	I_{CEV}	–	–	10 100	μA dc
Emitter Base Cutoff Current ($V_{EB} = 7.0\text{ Vdc}$, $I_C = 0$)	I_{EBO}	–	–	10	μA dc

ON CHARACTERISTICS (Note 2)

DC Current Gain ($I_C = 2.0\text{ Adc}$, $V_{CE} = 1.0\text{ Vdc}$) ($I_C = 4.0\text{ Adc}$, $V_{CE} = 1.0\text{ Vdc}$)	h_{FE}	35 20	– –	– –	–
Collector–Emitter Saturation Voltage ($I_C = 8.0\text{ Adc}$, $I_B = 0.4\text{ Adc}$) ($I_C = 8.0\text{ Adc}$, $I_B = 0.8\text{ Adc}$) ($I_C = 15\text{ Adc}$, $I_B = 3.0\text{ Adc}$, $T_C = 100^\circ\text{C}$)	$V_{CE(sat)}$	– – – –	– – – –	0.4 1.0 0.8 1.5	Vdc
Base–Emitter Saturation Voltage ($I_C = 8.0\text{ Adc}$, $I_B = 0.4\text{ Adc}$) ($I_C = 8.0\text{ Adc}$, $I_B = 0.8\text{ Adc}$) ($I_C = 8.0\text{ Adc}$, $I_B = 0.4\text{ Adc}$, $T_C = 100^\circ\text{C}$) ($I_C = 8.0\text{ Adc}$, $I_B = 0.8\text{ Adc}$, $T_C = 100^\circ\text{C}$)	$V_{BE(sat)}$	– – – –	– – – –	1.2 1.0 1.1 1.5	Vdc

DYNAMIC CHARACTERISTICS

Current Gain Bandwidth Product ($I_C = 0.1\text{ Adc}$, $V_{CE} = 10\text{ Vdc}$, $f = 20\text{ MHz}$)	f_T	–	50	–	MHz
Output Capacitance ($V_{CB} = 10\text{ Vdc}$, $I_C = 0$, $f_{test} = 1.0\text{ MHz}$)	C_{ob}	– –	120 275	– –	pF

SWITCHING CHARACTERISTICS

Delay Time	$(V_{CC} = 20\text{ Vdc}$, $I_C = 8.0\text{ Adc}$, $I_{B1} = I_{B2} = 0.8\text{ Adc}$)	t_d	–	–	50	ns
Rise Time		t_r	–	–	250	
Storage Time		t_s	–	–	700	
Fall Time		t_f	–	–	90	

2. Pulse Test: Pulse Width $\leq 300\ \mu\text{s}$, Duty Cycle $\leq 2\%$.

D44VH10 (NPN), D45VH10 (PNP)

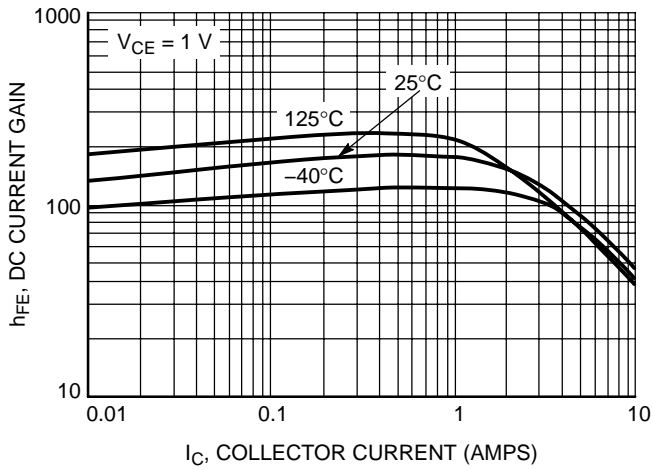

Figure 1. D44VH10 DC Current Gain

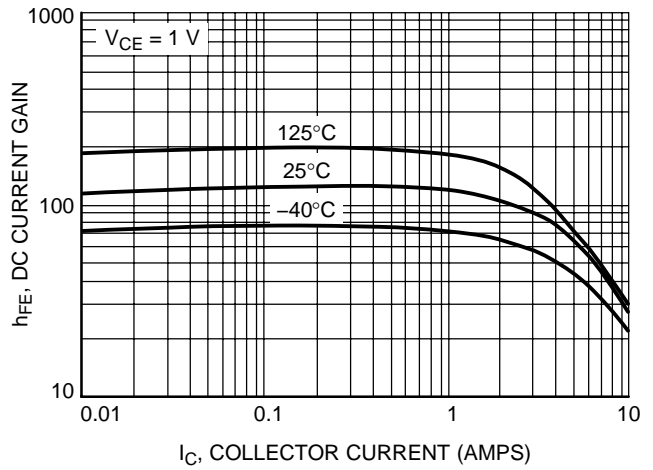

Figure 2. D45VH10 DC Current Gain

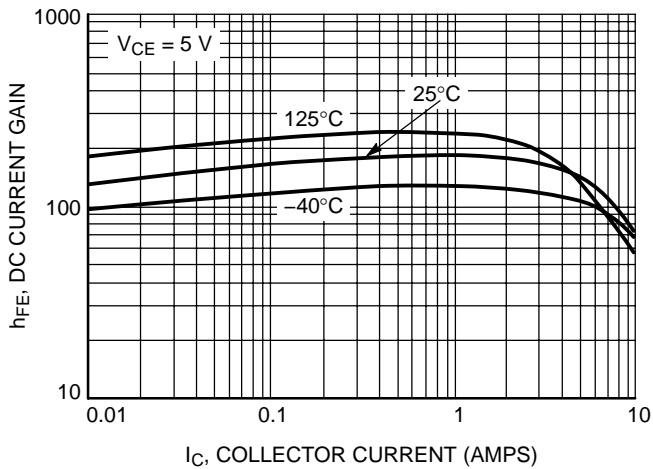

Figure 3. D44VH10 DC Current Gain

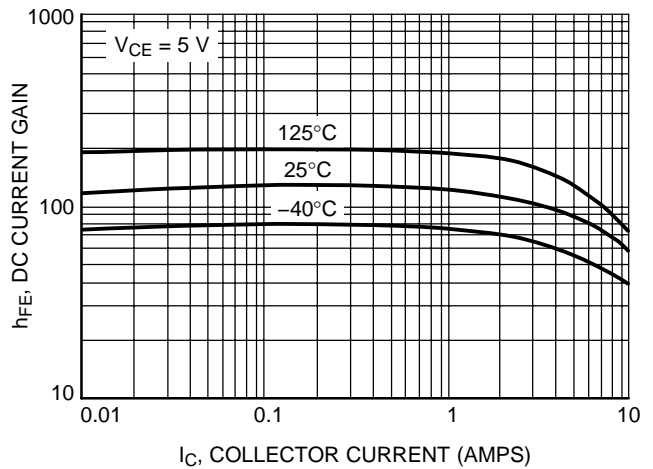

Figure 4. D45VH10 DC Current Gain

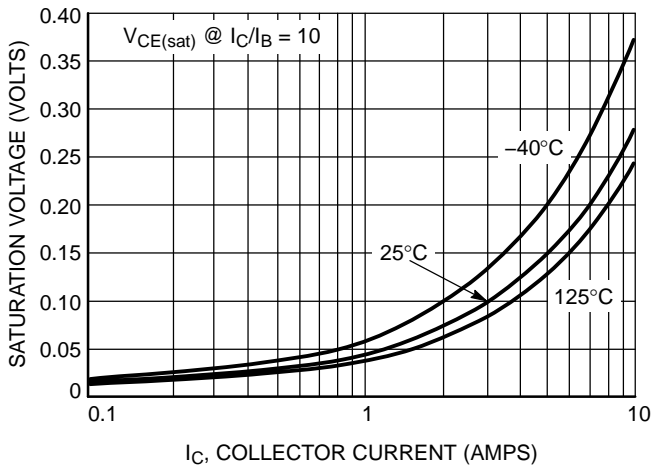

Figure 5. D44VH10 ON-Voltage

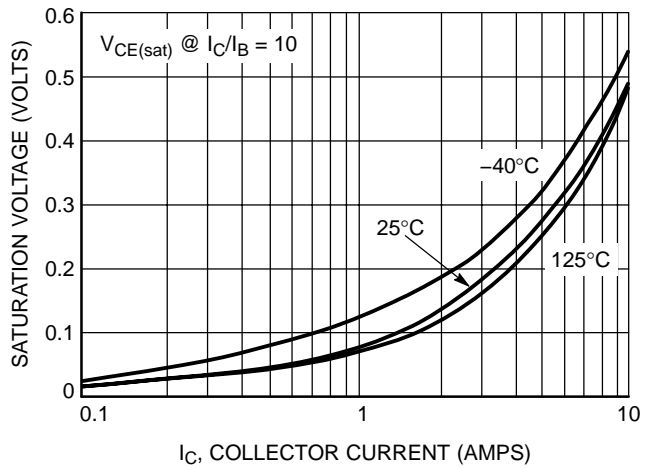

Figure 6. D45VH10 ON-Voltage

D44VH10 (NPN), D45VH10 (PNP)

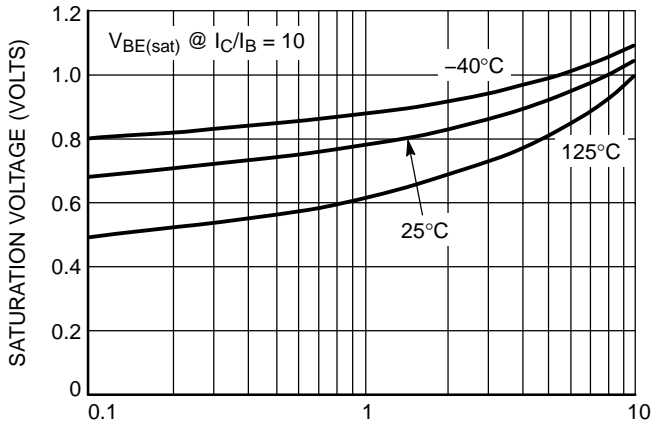

Figure 7. D44VH10 ON-Voltage

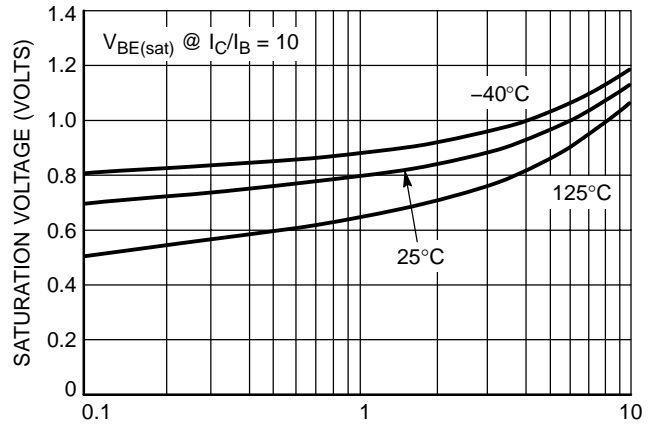

Figure 8. D45VH10 ON-Voltage

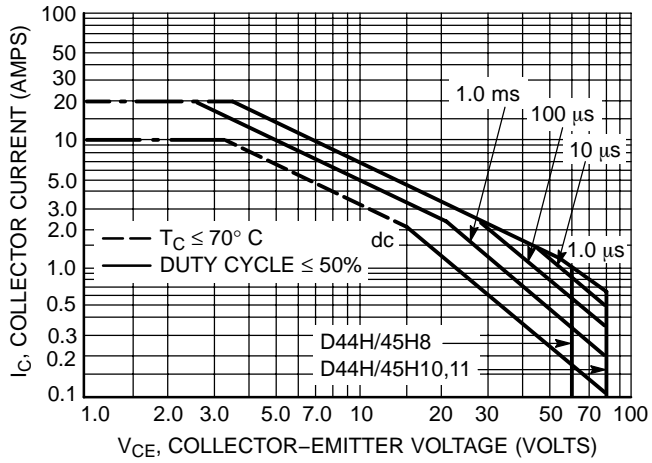

Figure 9. Maximum Rated Forward Bias Safe Operating Area

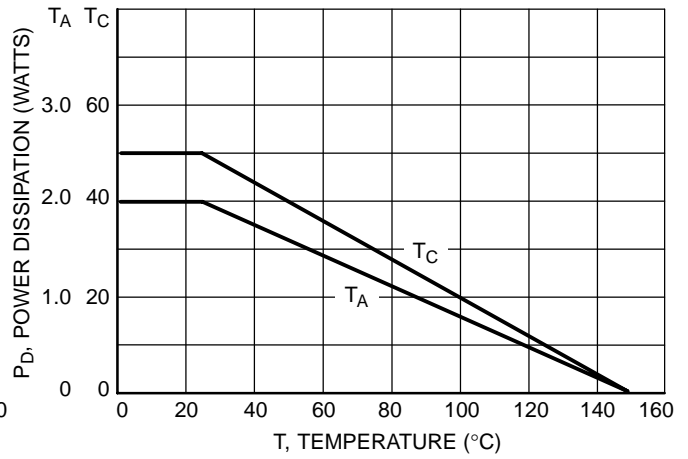

Figure 10. Power Derating

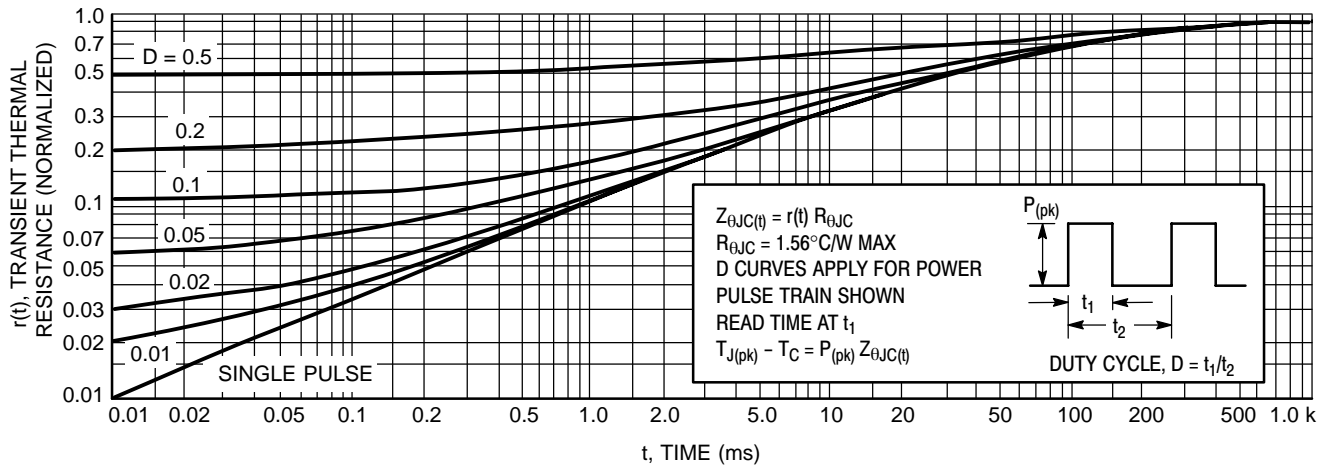
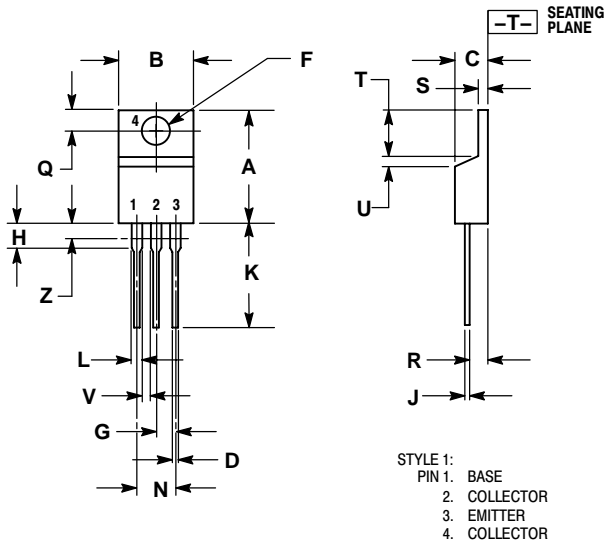

Figure 11. Thermal Response

D44VH10 (NPN), D45VH10 (PNP)

PACKAGE DIMENSIONS

TO-220AB
CASE 221A-09
ISSUE AA



- NOTES:
1. DIMENSIONING AND TOLERANCING PER ANSI Y14.5M, 1982.
 2. CONTROLLING DIMENSION: INCH.
 3. DIMENSION Z DEFINES A ZONE WHERE ALL BODY AND LEAD IRREGULARITIES ARE ALLOWED.

DIM	INCHES		MILLIMETERS	
	MIN	MAX	MIN	MAX
A	0.570	0.620	14.48	15.75
B	0.380	0.405	9.66	10.28
C	0.160	0.190	4.07	4.82
D	0.025	0.035	0.64	0.88
F	0.142	0.147	3.61	3.73
G	0.095	0.105	2.42	2.66
H	0.110	0.155	2.80	3.93
J	0.018	0.025	0.46	0.64
K	0.500	0.562	12.70	14.27
L	0.045	0.060	1.15	1.52
N	0.190	0.210	4.83	5.33
Q	0.100	0.120	2.54	3.04
R	0.080	0.110	2.04	2.79
S	0.045	0.055	1.15	1.39
T	0.235	0.255	5.97	6.47
U	0.000	0.050	0.00	1.27
V	0.045	---	1.15	---
Z	---	0.080	---	2.04

D44VH10 (NPN), D45VH10 (PNP)

ON Semiconductor and **ON** are registered trademarks of Semiconductor Components Industries, LLC (SCILLC). SCILLC reserves the right to make changes without further notice to any products herein. SCILLC makes no warranty, representation or guarantee regarding the suitability of its products for any particular purpose, nor does SCILLC assume any liability arising out of the application or use of any product or circuit, and specifically disclaims any and all liability, including without limitation special, consequential or incidental damages. "Typical" parameters which may be provided in SCILLC data sheets and/or specifications can and do vary in different applications and actual performance may vary over time. All operating parameters, including "Typicals" must be validated for each customer application by customer's technical experts. SCILLC does not convey any license under its patent rights nor the rights of others. SCILLC products are not designed, intended, or authorized for use as components in systems intended for surgical implant into the body, or other applications intended to support or sustain life, or for any other application in which the failure of the SCILLC product could create a situation where personal injury or death may occur. Should Buyer purchase or use SCILLC products for any such unintended or unauthorized application, Buyer shall indemnify and hold SCILLC and its officers, employees, subsidiaries, affiliates, and distributors harmless against all claims, costs, damages, and expenses, and reasonable attorney fees arising out of, directly or indirectly, any claim of personal injury or death associated with such unintended or unauthorized use, even if such claim alleges that SCILLC was negligent regarding the design or manufacture of the part. SCILLC is an Equal Opportunity/Affirmative Action Employer. This literature is subject to all applicable copyright laws and is not for resale in any manner.

PUBLICATION ORDERING INFORMATION

LITERATURE FULFILLMENT:

Literature Distribution Center for ON Semiconductor
P.O. Box 61312, Phoenix, Arizona 85082-1312 USA

Phone: 480-829-7710 or 800-344-3860 Toll Free USA/Canada

Fax: 480-829-7709 or 800-344-3867 Toll Free USA/Canada

Email: orderlit@onsemi.com

N. American Technical Support: 800-282-9855 Toll Free
USA/Canada

Japan: ON Semiconductor, Japan Customer Focus Center

2-9-1 Kamimeguro, Meguro-ku, Tokyo, Japan 153-0051

Phone: 81-3-5773-3850

ON Semiconductor Website: <http://onsemi.com>

Order Literature: <http://www.onsemi.com/litorder>

For additional information, please contact your
local Sales Representative.