

Distributed by:

**JAMECO**<sup>®</sup>  
ELECTRONICS

**www.Jameco.com ♦ 1-800-831-4242**

The content and copyrights of the attached  
material are the property of its owner.

Jameco Part Number 812560



# STPS20H100CT/CF/CG/CR/CFP

## HIGH VOLTAGE POWER SCHOTTKY RECTIFIER

### MAIN PRODUCT CHARACTERISTICS

$I_{F(AV)}$	<b>2 x 10 A</b>
$V_{RRM}$	<b>100 V</b>
$T_j$	<b>175°C</b>
$V_F(\text{max})$	<b>0.64 V</b>

### FEATURES AND BENEFITS

- NEGLIGIBLE SWITCHING LOSSES
- HIGH JUNCTION TEMPERATURE CAPABILITY
- GOOD TRADE OFF BETWEEN LEAKAGE CURRENT AND FORWARD VOLTAGE DROP
- LOW LEAKAGE CURRENT
- AVALANCHE RATED
- INSULATED PACKAGE: ISOWATT220AB, TO-220FPAB  
Insulating Voltage = 2000V DC  
Capacitance = 45 pF
- AVALANCHE CAPABILITY SPECIFIED

### DESCRIPTION

Dual center tap schottky rectifier designed for high frequency miniature Switched Mode Power Supplies such as adaptators and on board DC/DC converters.

### ABSOLUTE RATINGS (limiting values, per diode)

Symbol	Parameter			Value	Unit	
$V_{RRM}$	Repetitive peak reverse voltage			100	V	
$I_{F(RMS)}$	RMS forward current			30	A	
$I_{F(AV)}$	Average forward current $\delta = 0.5$	TO-220AB D <sup>2</sup> PAK / I <sup>2</sup> PAK	$T_c = 160^\circ\text{C}$	per diode per device	10 20	A
		ISOWATT220AB TO-220FPAB	$T_c = 145^\circ\text{C}$			
$I_{FSM}$	Surge non repetitive forward current		$t_p = 10 \text{ ms}$ sinusoidal	250	A	
$I_{RRM}$	Repetitive peak reverse current		$t_p = 2 \mu\text{s}$ square $F = 1 \text{ kHz}$	1	A	
$I_{RSM}$	Non repetitive peak reverse current		$t_p = 100 \mu\text{s}$ square	3	A	
$P_{ARM}$	Repetitive peak avalanche power		$t_p = 1 \mu\text{s}$ $T_j = 25^\circ\text{C}$	10800	W	
$T_{stg}$	Storage temperature range			- 65 to + 175	°C	
$T_j$	Maximum operating junction temperature *			175	°C	
$dV/dt$	Critical rate of rise of reverse voltage			10000	V/ $\mu\text{s}$	

\* :  $\frac{dP_{tot}}{dT_j} < \frac{1}{R_{th(j-a)}}$  thermal runaway condition for a diode on its own heatsink

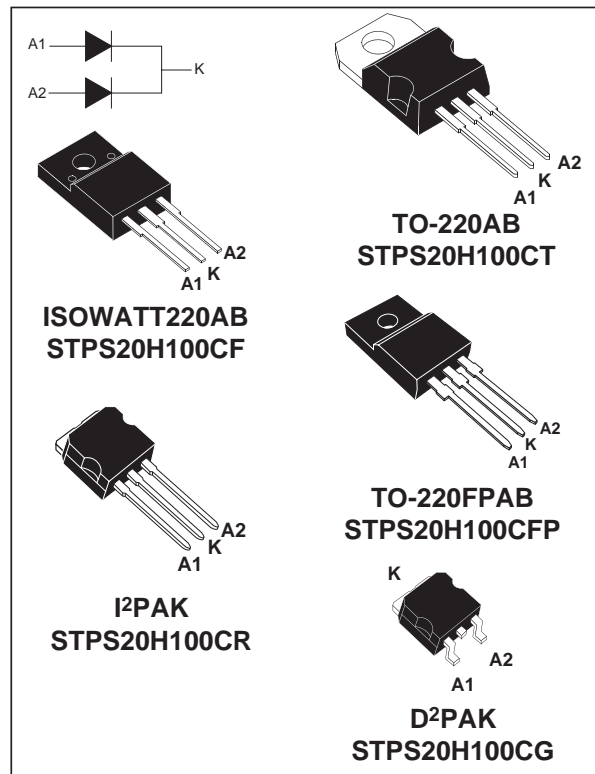

## STPS20H100CT/CF/CG/CR/CFP

### THERMAL RESISTANCES

Symbol	Parameter			Value	Unit
$R_{th(j-c)}$	Junction to case	TO-220AB / D <sup>2</sup> PAK / I <sup>2</sup> PAK	Per diode	1.6	°C/W
		ISOWATT220AB / TO-220FPAB	Per diode	4	
		TO-220AB / D <sup>2</sup> PAK / I <sup>2</sup> PAK	Total	0.9	
		ISOWATT220AB / TO-220FPAB	Total	3.2	°C/W
$R_{th(c)}$		TO-220AB / D <sup>2</sup> PAK / I <sup>2</sup> PAK	Coupling	0.15	°C/W
		ISOWATT220AB / TO-220FPAB	Coupling	2.5	

When the diodes 1 and 2 are used simultaneously :

$$\Delta T_j(\text{diode } 1) = P(\text{diode } 1) \times R_{th(j-c)}(\text{Per diode}) + P(\text{diode } 2) \times R_{th(c)}$$

### STATIC ELECTRICAL CHARACTERISTICS (per diode)

Symbol	Parameter	Tests conditions		Min.	Typ.	Max.	Unit
$I_R^*$	Reverse leakage current	$T_j = 25^\circ\text{C}$	$V_R = V_{RRM}$			4.5	$\mu\text{A}$
		$T_j = 125^\circ\text{C}$			2	6	mA
$V_F^{**}$	Forward voltage drop	$T_j = 25^\circ\text{C}$	$I_F = 8\text{ A}$			0.71	V
		$T_j = 25^\circ\text{C}$	$I_F = 10\text{ A}$			0.77	
		$T_j = 25^\circ\text{C}$	$I_F = 16\text{ A}$			0.81	
		$T_j = 25^\circ\text{C}$	$I_F = 20\text{ A}$			0.88	
		$T_j = 125^\circ\text{C}$	$I_F = 8\text{ A}$		0.56	0.58	
		$T_j = 125^\circ\text{C}$	$I_F = 10\text{ A}$		0.59	0.64	
		$T_j = 125^\circ\text{C}$	$I_F = 16\text{ A}$		0.65	0.68	
		$T_j = 125^\circ\text{C}$	$I_F = 20\text{ A}$		0.67	0.73	

Pulse test : \*  $t_p = 5\text{ ms}$ ,  $\delta < 2\%$

\*\*  $t_p = 380\text{ }\mu\text{s}$ ,  $\delta < 2\%$

To evaluate the maximum conduction losses use the following equation :

$$P = 0.55 \times I_{F(AV)} + 0.009 \times I_{F(RMS)}^2$$

**Fig. 1:** Average forward power dissipation versus average forward current (per diode).

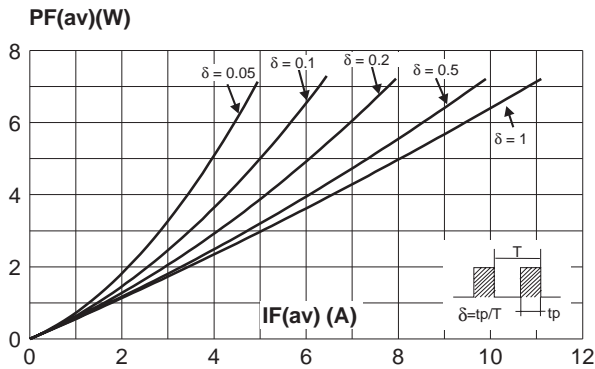

**Fig. 2:** Average forward current versus ambient temperature ( $\delta=0.5$ , per diode).

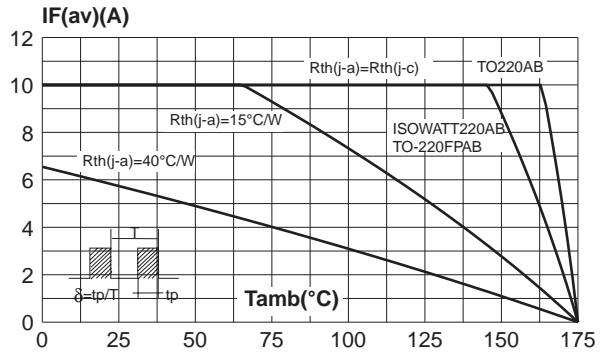

**Fig. 3:** Normalized avalanche power derating versus pulse duration.

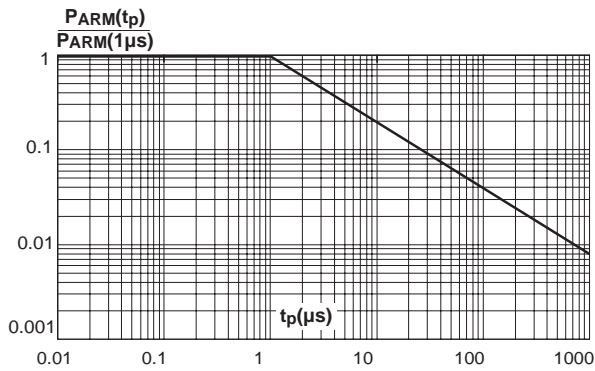

**Fig. 4:** Normalized avalanche power derating versus junction temperature.

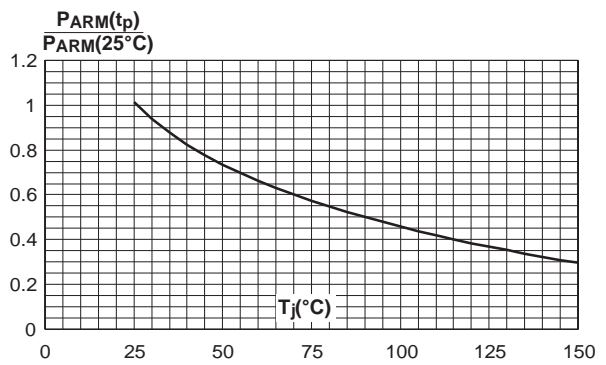

**Fig. 5:** Non repetitive surge peak forward current versus overload duration (maximum values, per diode) (TO-220AB, D<sup>2</sup>PAK, I<sup>2</sup>PAK)

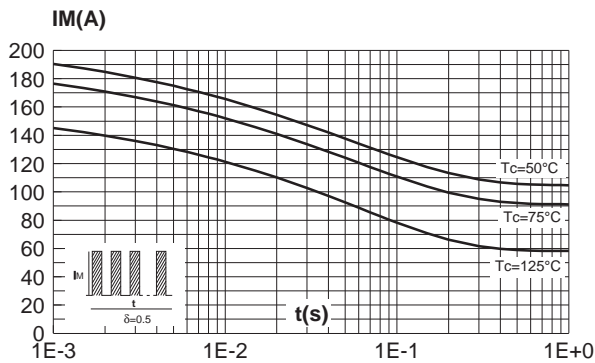

**Fig. 6:** Non repetitive surge peak forward current versus overload duration (maximum values, per diode) (ISOWATT220AB, TO-220FPAB).

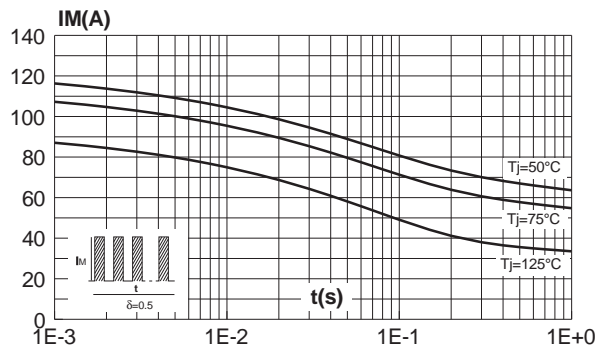

**Fig. 7-1:** Relative variation of thermal impedance junction to case versus pulse duration (per diode) (TO-220AB, D<sup>2</sup>PAK, I<sup>2</sup>PAK).

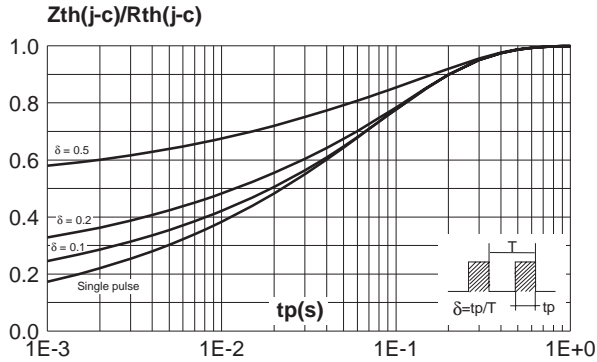

**Fig. 7-2:** Relative variation of thermal impedance junction to case versus pulse duration (per diode) (ISOWATT220AB, TO-220FPAB).

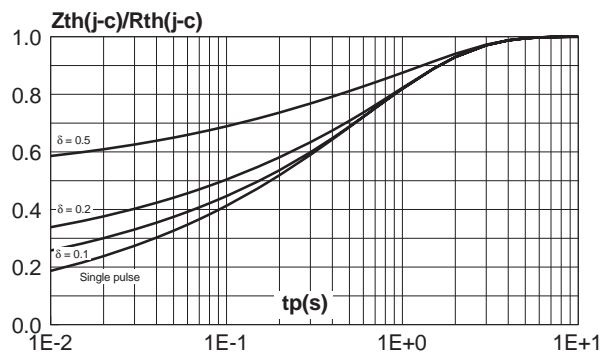

**Fig. 8:** Reverse leakage current versus reverse voltage applied (typical values, per diode).

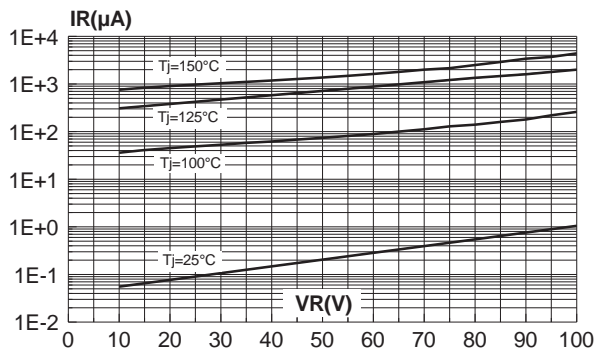

**Fig. 9:** Junction capacitance versus reverse voltage applied (typical values, per diode).

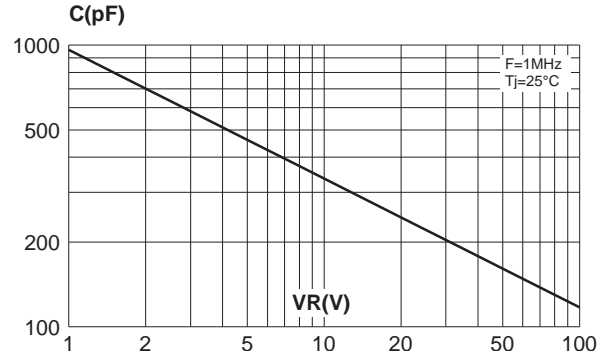

**Fig. 10:** Forward voltage drop versus forward current (maximum values, per diode).

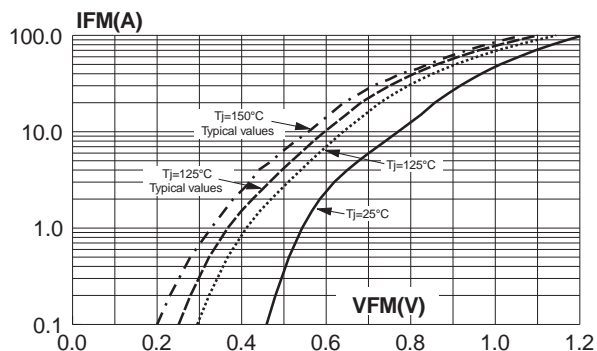

**Fig. 11:** Thermal resistance junction to ambient versus copper surface under tab (Epoxy printed circuit board FR4, copper thickness: 35μm) (D<sup>2</sup>PAK).

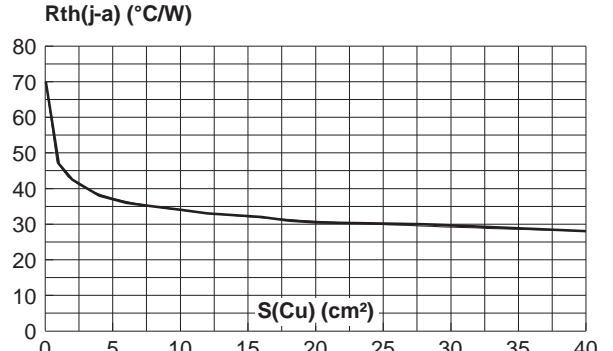

**PACKAGE MECHANICAL DATA**  
TO-220AB

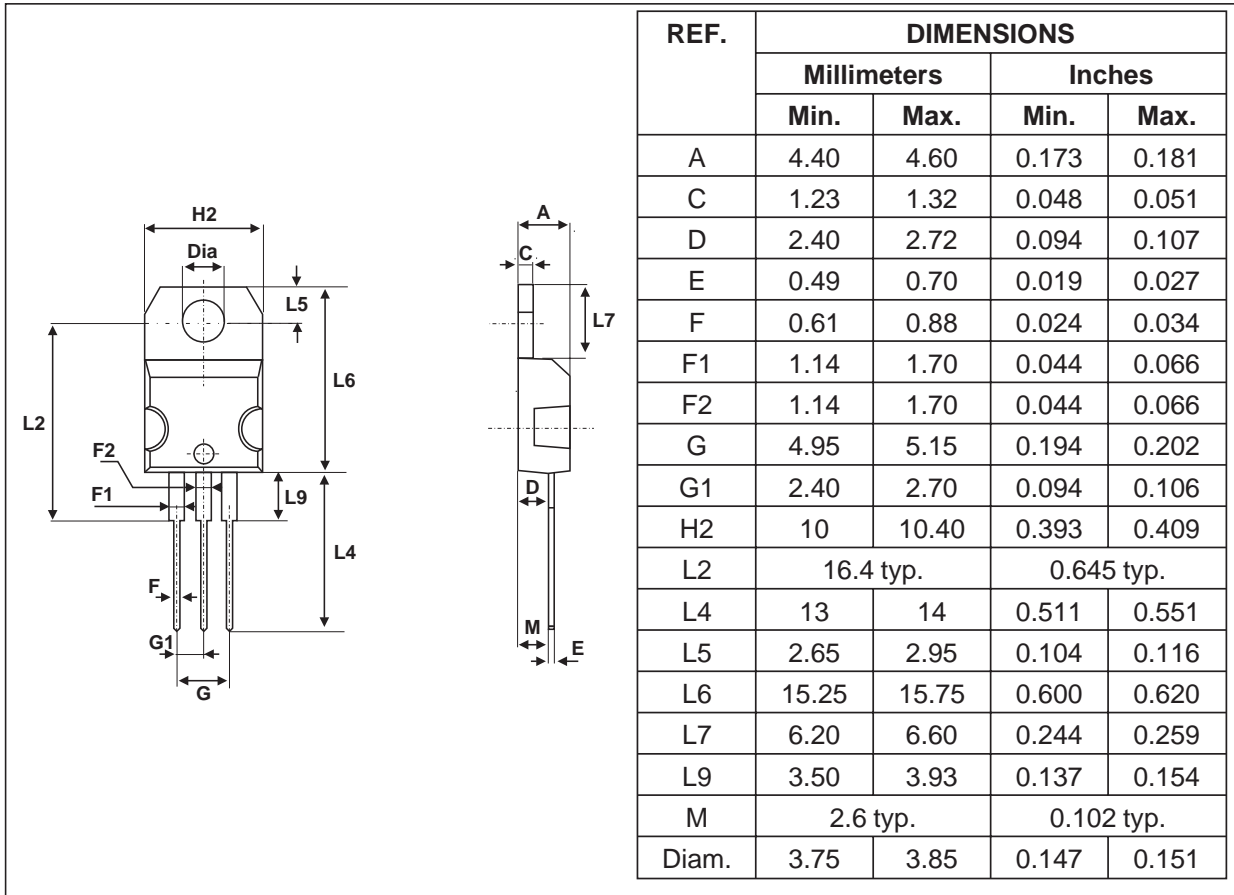

**STPS20H100CT/CF/CG/CR/CFP**

**PACKAGE MECHANICAL DATA**  
ISOWATT220AB

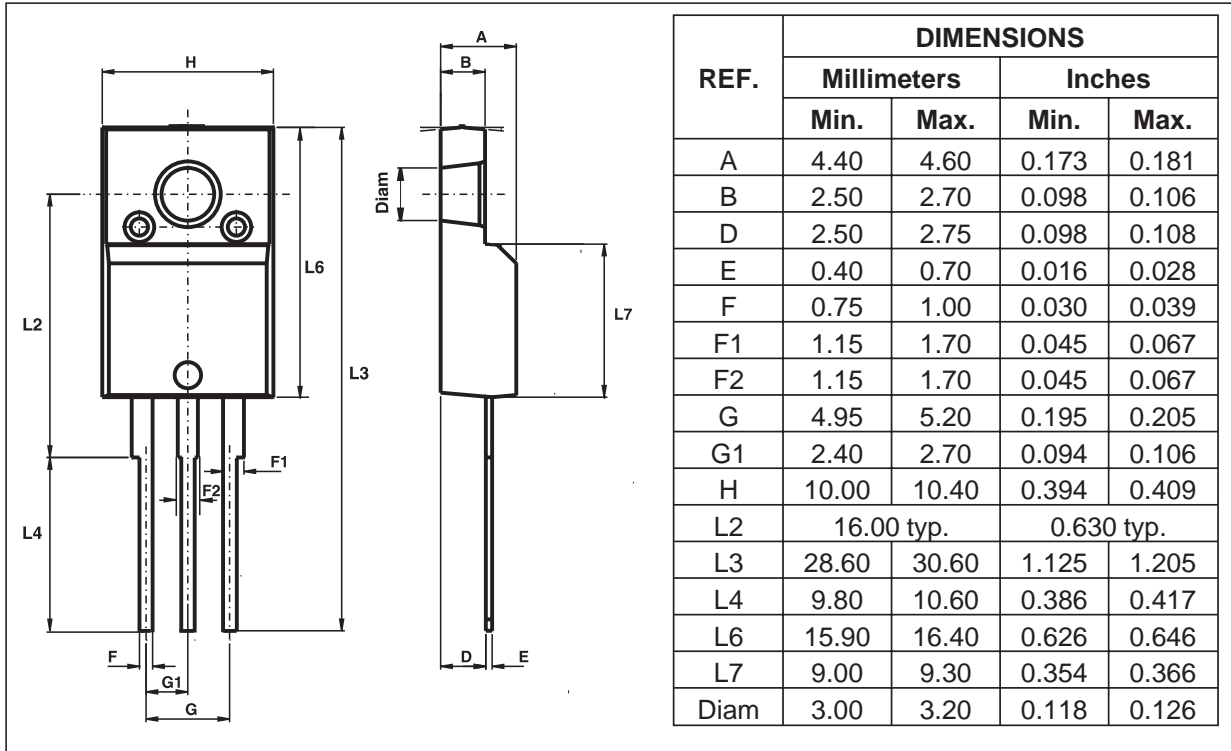

**PACKAGE MECHANICAL DATA**  
TO-220FPAB

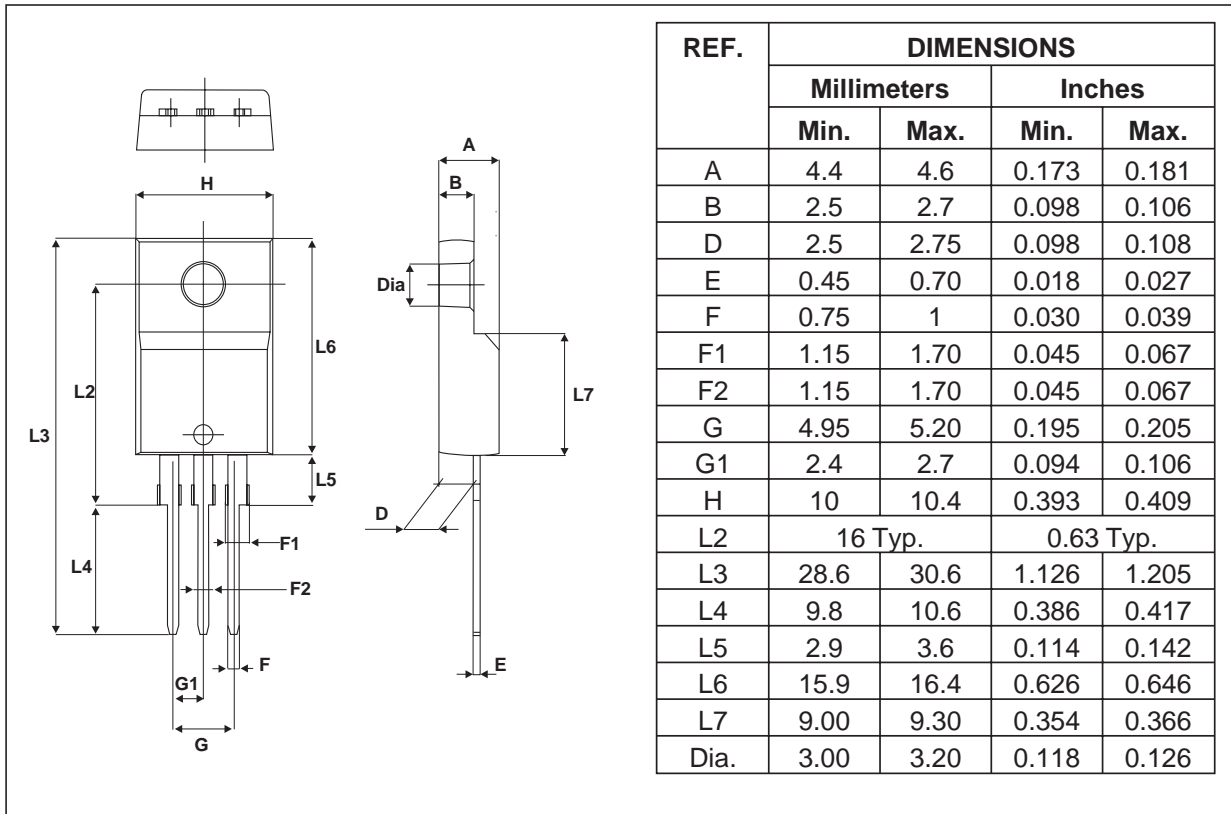

**PACKAGE MECHANICAL DATA**  
D<sup>2</sup>PAK

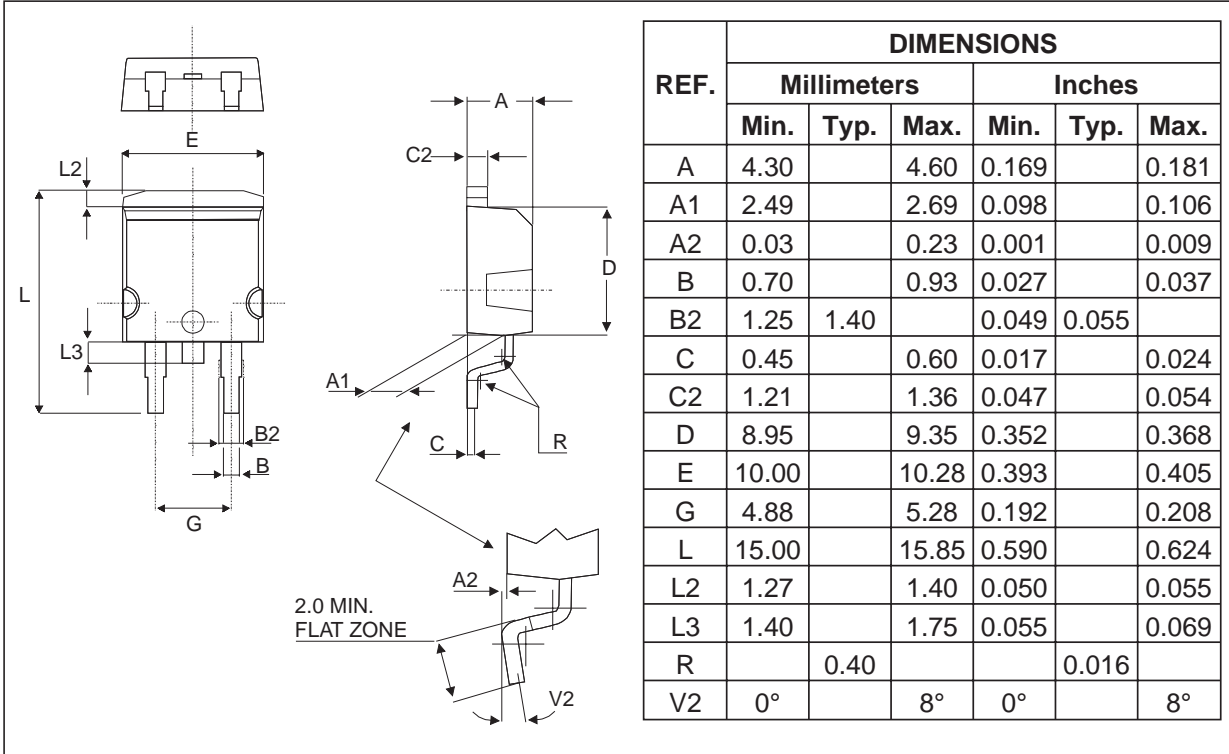

**FOOT PRINT DIMENSIONS (in millimeters)**

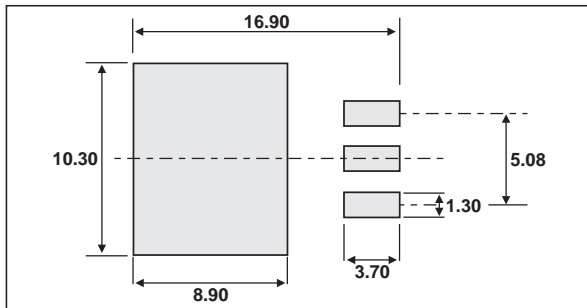



# STPS20H100CT/CF/CG/CR/CFP

## PACKAGE MECHANICAL DATA I<sup>2</sup>PAK

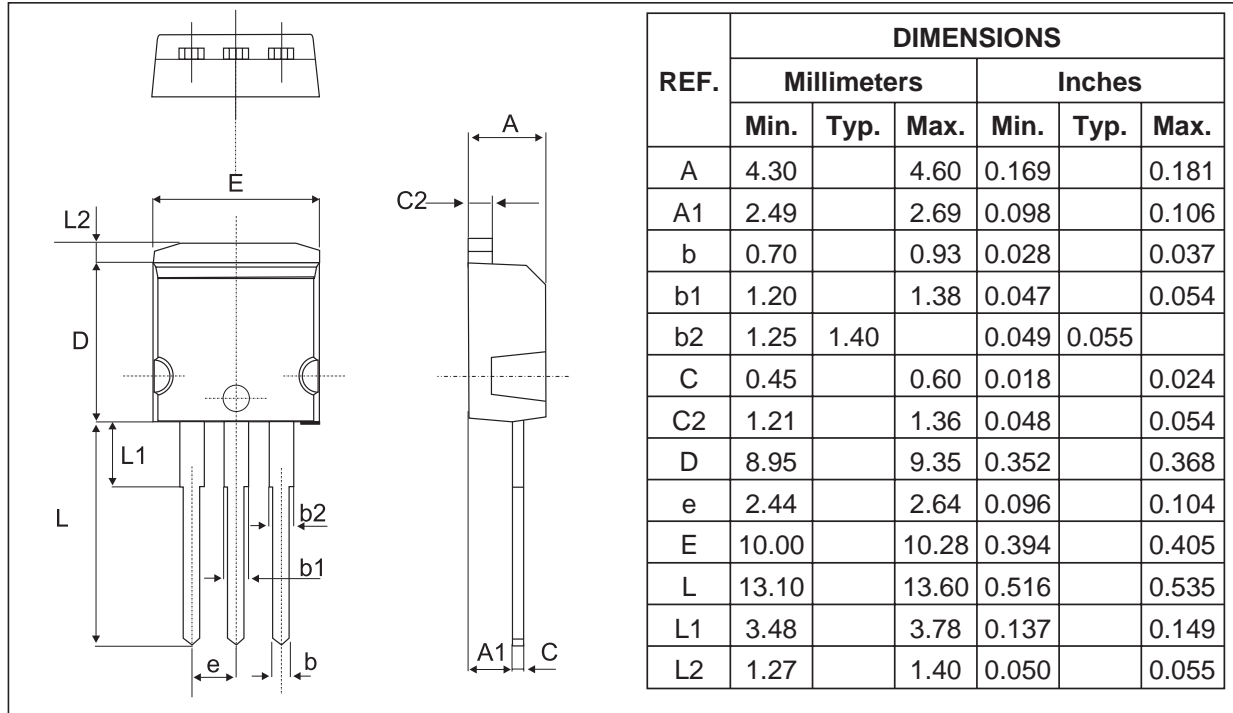

Ordering type	Marking	Package	Weight	Base qty	Delivery mode
STPS20H100CT	STPS20H100CT	TO-220AB	2.20g	50	Tube
STPS20H100CF	STPS20H100CF	ISOWATT220AB	2.08g	50	Tube
STPS20H100CFP	STPS20H100CFP	TO-220FPAB	2.0 g	50	Tube
STPS20H100CR	STPS20H100CR	I <sup>2</sup> PAK	1.49g	50	Tube
STPS20H100CG	STPS20H100CG	D <sup>2</sup> PAK	1.48g	50	Tube
STPS20H100CG-TR	STPS20H100CG	D <sup>2</sup> PAK	1.48g	1000	Tape & reel

- Epoxy meets UL94,V0

Information furnished is believed to be accurate and reliable. However, STMicroelectronics assumes no responsibility for the consequences of use of such information nor for any infringement of patents or other rights of third parties which may result from its use. No license is granted by implication or otherwise under any patent or patent rights of STMicroelectronics. Specifications mentioned in this publication are subject to change without notice. This publication supersedes and replaces all information previously supplied. STMicroelectronics products are not authorized for use as critical components in life support devices or systems without express written approval of STMicroelectronics.

The ST logo is a registered trademark of STMicroelectronics  
 © 2003 STMicroelectronics - Printed in Italy - All rights reserved.  
 STMicroelectronics GROUP OF COMPANIES  
 Australia - Brazil - Canada - China - Finland - France - Germany  
 Hong Kong - India - Israel - Italy - Japan - Malaysia - Malta - Morocco - Singapore  
 Spain - Sweden - Switzerland - United Kingdom - United States.

<http://www.st.com>