

Distributed by:

JAMECO[®]
ELECTRONICS

www.Jameco.com ♦ 1-800-831-4242

The content and copyrights of the attached
material are the property of its owner.

Jameco Part Number 860166



Four Output PCI-X and General Purpose Buffer

Features

- One input to four output buffer/driver
- General-purpose or PCI-X clock buffer
- Buffers all frequencies from DC to 140 MHz
- Output-to-output skew less than 100 ps
- Space-saving 8-pin TSSOP package
- 3.3V operation
- 60 ps typical output-output skew

Functional Description

The CY2304NZ is a low-cost buffer designed to distribute high-speed clocks for PCI-X and other applications. The device operates at 3.3V and outputs can run up to 140 MHz.

Table 1. Function Table

Inputs		Outputs
BUF_IN	OE	Output [1:4]
L	L	L
H	L	L
L	H	L
H	H	H

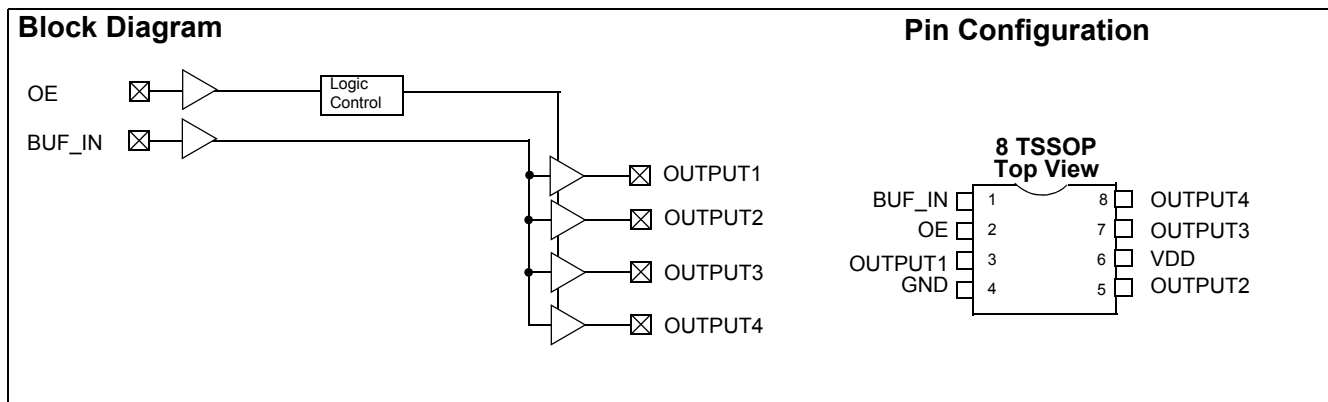

Pin Description for CY2304NZ

Signal	Pin	Description
V _{DD}	6	3.3V voltage supply
GND	4	Ground
BUF_IN	1	Input clock
OUTPUT [1:4]	3, 5, 7, 8	Outputs
OE	2	Input pin for output enable, active HIGH.

Maximum Ratings

Supply Voltage to Ground Potential -0.5V to $V_{DD} + 0.5V$
 DC Input Voltage (Except REF) -0.5V to $V_{DD} + 0.5V$
 DC Input Voltage REF -0.5V to $V_{DD} + 0.5V$

Storage Temperature -65°C to +150°C
 Max. Soldering Temperature (10 sec.) 260°C
 Junction Temperature 150°C
 Static Discharge Voltage
 (per MIL-STD-883, Method 3015) > 2,000V

Operating Conditions

Parameter	Description	Min.	Max.	Unit
V_{DD}	Supply Voltage	3.0	3.6	V
T_A	Operating Temperature (Ambient Temperature)	-40	85	°C
C_L	Load Capacitance	-	25	pF
C_{IN}	Input Capacitance	-	7	pF
BUF_IN, OUTPUT [1:4]	Operating Frequency	DC	140	MHz
t_{PU}	Power-up time for all V_{DD} 's to reach minimum specified voltage (power ramps must be monotonic)	0.05	50	ms

Electrical Characteristics

Parameter	Description	Test Conditions	Min.	Max.	Unit
V_{IL}	Input LOW Voltage ^[1]		-	0.8	V
V_{IH}	Input HIGH Voltage ^[1]		2.0	-	V
I_{IL}	Input LOW Current	$V_{IN} = 0V$	-5	5	μA
I_{IH}	Input HIGH Current	$V_{IN} = V_{DD}$	-5	5	μA
V_{OL}	Output LOW Voltage ^[2]	$I_{OL} = 24\text{ mA}$	-	0.8	V
		$I_{OL} = 12\text{ mA}$	-	0.55	V
V_{OH}	Output HIGH Voltage ^[2]	$I_{OH} = -24\text{ mA}$	2.0	-	V
		$I_{OH} = -12\text{ mA}$	2.4	-	V
I_{DD}	Supply Current	Unloaded outputs at 66.66 MHz	-	25	mA

Switching Characteristics^[3] for Commercial and Industrial Temperature Devices

Parameter	Name	Description	Min.	Typ.	Max.	Unit
	Duty Cycle ^[2] = $t_2 \div t_1$	Measured at 1.5V	40.0	50.0	60.0	%
t_3	Rise Time ^[2]	Measured between 0.8V and 2.0V	-	-	1.50	ns
t_4	Fall Time ^[2]	Measured between 0.8V and 2.0V	-	-	1.50	ns
t_5	Output to Output Skew ^[2]	All outputs equally loaded	-	60	100	ps
t_6	Propagation Delay, BUF_IN Rising Edge to OUTPUT Rising Edge ^[2]	Measured at $V_{DD}/2$	2.5	3.5	5	ns

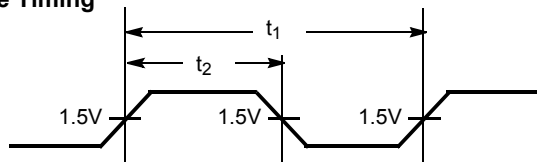
Switching Waveforms
Duty Cycle Timing

Notes:

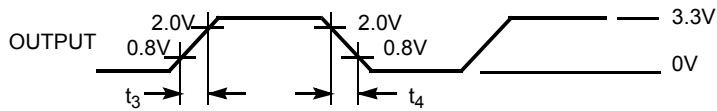
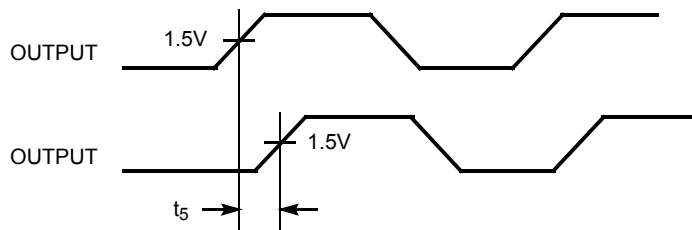
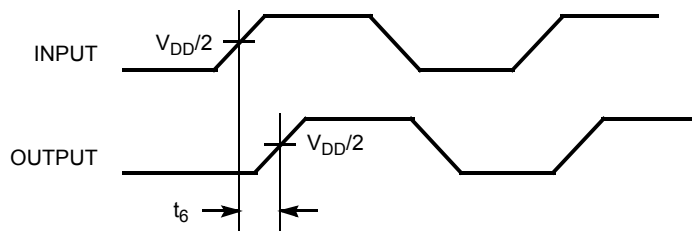
1. BUF_IN input has a threshold voltage of $V_{DD}/2$.
2. Parameter is guaranteed by design and characterization. It is not 100% tested in production.
3. All parameters specified with loaded outputs.

Switching Waveforms (continued)
All Outputs Rise/Fall Time

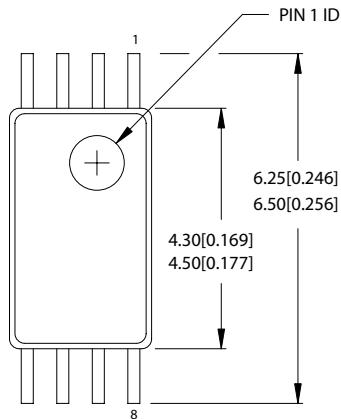
Output-Output Skew

Input-Output Propagation Delay

Ordering Information

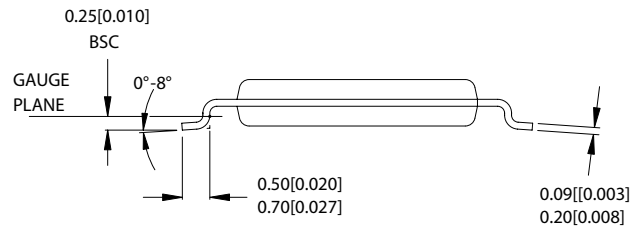
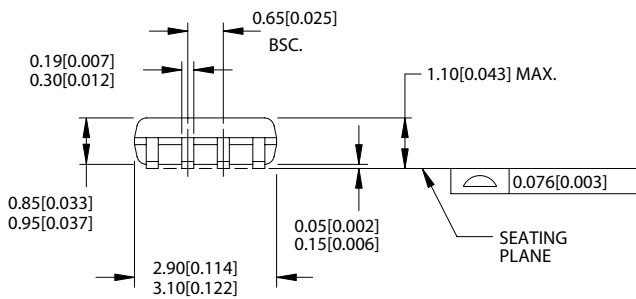
Ordering Code	Package Type	Operating Range
Standard		
CY2304NZZC-1	8-pin TSSOP	Commercial, 0°C to 70°C
CY2304NZZC-1T	8-pin TSSOP – Tape and Reel	Commercial, 0°C to 70°C
CY2304NZZI-1	8-pin TSSOP	Industrial, -40°C to 85°C
CY2304NZZI-1T	8-pin TSSOP – Tape and Reel	Industrial, -40°C to 85°C
Lead-free		
CY2304NZZXC-1	8-pin TSSOP	Commercial, 0°C to 70°C
CY2304NZZXC-1T	8-pin TSSOP – Tape and Reel	Commercial, 0°C to 70°C
CY2304NZZXI-1	8-pin TSSOP	Industrial, -40°C to 85°C
CY2304NZZXI-1T	8-pin TSSOP – Tape and Reel	Industrial, -40°C to 85°C

Package Diagram
8-Lead Thin Shrunk Small Outline Package (4.40 MM Body) Z8

DIMENSIONS IN MM[INCHES] MIN.
MAX.



51-85093-A

All product and company names mentioned in this document are the trademarks of their respective holders.

Document History Page

Document Title: CY2304NZ Four Output PCI-X and General Purpose Buffer				
Document Number: 38-07099				
REV.	ECN NO.	Issue Date	Orig. of Change	Description of Change
**	111420	02/12/02	IKA	New data sheet
*A	118610	09/25/02	HWT	Added Industrial Temperature Range in the Ordering Information
*B	121820	12/14/02	RBI	Power-up requirements added to Operating Conditions Information
*C	291098	See ECN	RGL	Added Lead-free Devices Specified typical value for output-output skew