

Distributed by:

JAMECO[®]
ELECTRONICS

www.Jameco.com ♦ 1-800-831-4242

The content and copyrights of the attached
material are the property of its owner.

Jameco Part Number 882226

FEATURES AND SPECIFICATIONS

Features and Benefits

- Peg-mounted for increased board retention
- Low profile for space constraints
- Positive housing locks
- Fully isolated terminals to protect contacts from damage

Reference Information

Product Specification: PS-5556-0001
 Packaging: Tray or bag
 UL File No.: E29179
 CSA File No.: LR19980
 TUV License No.: R75142
 Mates With: [5557](#) dual row receptacle
 Designed In: Millimeters

Electrical

Voltage: 600V
 Current: (Used with 16 AWG)

Circuits	2-3	4-6	7-10	12-24
Amperes-Jr.	9	8	7	6
Amperes-HCS	12	11	10	9

Contact Resistance: 10mΩ max.
 Dielectric Withstanding Voltage: 1500V
 Insulation Resistance: 1000 MΩ min.

Mechanical

Insertion Force to PCB: 5.0kg max.
 Mating Force: 0.7kg (1.54 lb) max.
 Unmating Force: 0.35kg (0.7 lb) min.
 Normal Force: 200g min.
 Durability: 30 cycles

Physical

Housing: 6/6 nylon, UL 94V-2 or 94V-0
 Contact: Brass
 Plating: Tin, select Gold or overall Gold
 Operating Temperature: -40 to +105°C

molex® 4.20mm (.165") Pitch Mini-Fit, Jr.™ Header

5569

Right Angle, Dual Row With Pegs

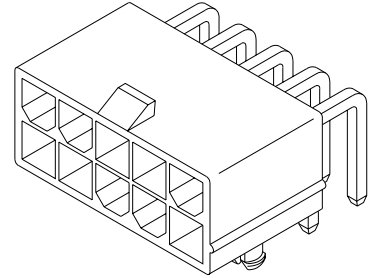

Power Connectors

F

CATALOG DRAWING (FOR REFERENCE ONLY)

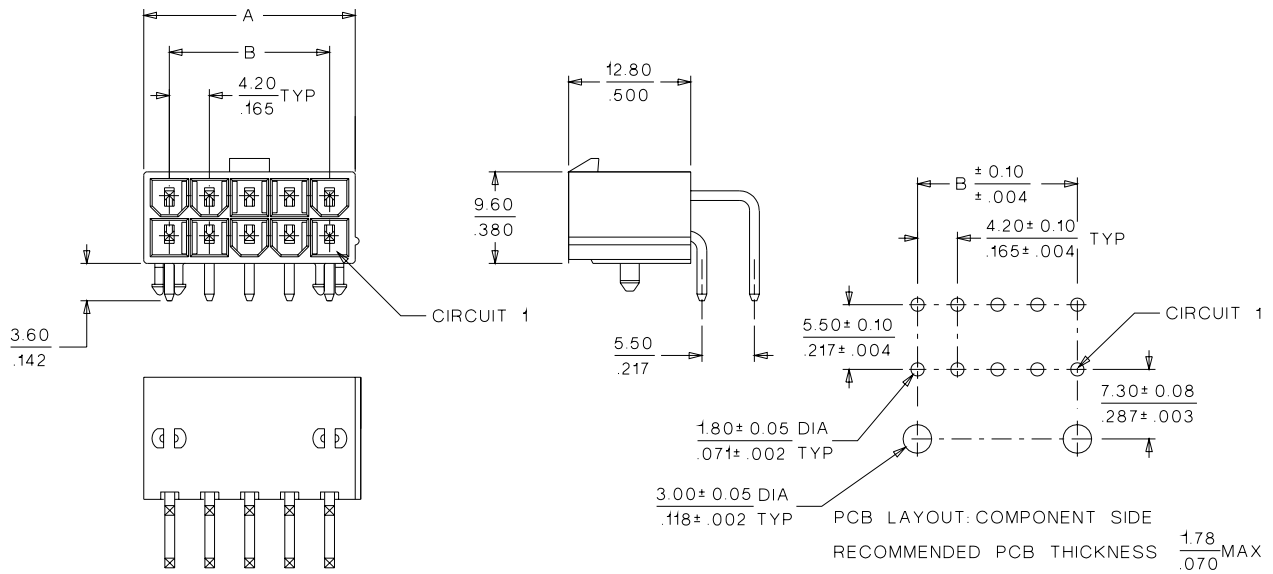

ORDERING INFORMATION AND DIMENSIONS

Circuits	Order No.						Dimension	
	Tin Plated		Gold Plated (30μ")		Select Gold Plated (30μ")		A	B
	94V-2	94V-0	94V-2	94V-0	94V-2	94V-0		
2	● 39-30-1020	● 39-30-0020	39-30-1021	39-30-1022	39-30-0023	39-30-0024	5.40 (.213)	
4	● 39-30-1040	● 39-30-0040	39-30-1041	39-30-1042	39-30-0043	39-30-0044	9.60 (.378)	4.20 (.165)
6	● 39-30-1060	● 39-30-0060	39-30-1061	39-30-1062			13.80 (.543)	8.40 (.331)
8	● 39-30-1080	● 39-30-0080	39-30-1081	39-30-1082			18.00 (.709)	12.60 (.496)
10	● 39-30-1100	● 39-30-0100	39-30-1101	39-30-1102			22.20 (.874)	16.80 (.661)
12	● 39-30-1120	● 39-30-0120	39-30-1121	39-30-1122			26.40 (1.039)	21.00 (.827)
14	● 39-30-1140	● 39-30-0140	39-30-1141	39-30-1142			30.60 (1.205)	25.20 (.992)
16	● 39-30-1160	● 39-30-0160	39-30-1161	39-30-1162			34.80 (1.370)	29.40 (1.158)
18	● 39-30-1180		39-30-1181				39.00 (1.535)	33.60 (1.323)
20	● 39-30-1200	● 39-30-0200	39-30-1201	39-30-1202			43.20 (1.701)	37.80 (1.488)
22	● 39-30-1220		39-30-1221				47.40 (1.866)	42.00 (1.654)
24	● 39-30-1240	● 39-30-0240	39-30-1241	39-30-1242			51.60 (2.031)	46.20 (1.819)

● US Standard Product, available through Molex franchised distributors



PRODUCT SPECIFICATION

MINI-FIT JR.

1.0 SCOPE

This Product Specification covers performance requirements for the MINI-FIT JR. 4.20 mm (.165 inch) centerline (pitch) printed circuit board (PCB) connector series with Tin or Gold plating, and The MINI-FIT JR. connector series terminated with 16 to 28 AWG wire using Crimp technology with Tin or Gold plating.

2.0 PRODUCT DESCRIPTION

2.1 PRODUCT NAME AND SERIES NUMBER (S)

<u>PRODUCT NAME</u>	<u>PART NUMBER</u>
Female Crimp Terminal	5556-****
Male Crimp Terminal	5558-****
Receptacle Housing	5557-****
Plug Housing	5559-****
Vertical Header Assembly	5566-****
Right Angle Header Assembly	5569-****

2.2 DIMENSIONS, MATERIALS, PLATINGS AND MARKINGS

See the appropriate sales drawings for the information on dimensions, materials, platings and markings.

2.3 SAFETY AGENCY APPROVALS

UL File: E29179
CSA Certificate: LR 19980
TUV Certificate: R75142-8

3.0 APPLICABLE DOCUMENTS AND SPECIFICATIONS

See sales drawings and the other sections of this specification for the necessary referenced documents and specifications

4.0 RATINGS

4.1 VOLTAGE

600 Volts AC (RMS) (or 600 Volts DC)

4.2 CURRENT AND APPLICABLE WIRES

Maximum Insulation Diameter and Applicable Wire Gauges	16 AWG: 3.10/. 122 MAXIMUM
	18-24 AWG: 3.10/. 122 MAXIMUM
	22-28 AWG: 1.80/. 071 MAXIMUM

<u>REVISION:</u> C	<u>EGR/ECN INFORMATION:</u> EC No: UCP2004-2349 DATE: 2004 / 05 / 25	<u>TITLE:</u> PRODUCT SPECIFICATION FOR MINI-FIT JR. CONNECTOR SYSTEM	<u>SHEET No.</u> 1 of 5
<u>DOCUMENT NUMBER:</u> PS-5556-001	<u>CREATED / REVISED BY:</u> BANDURA	<u>CHECKED BY:</u> BANDURA	<u>APPROVED BY:</u> MARGULIS



PRODUCT SPECIFICATION

4.2 CURRENT AND APPLICABLE WIRES (continued)

MAXIMUM CURRENT RATING (Amperes)									
Brass					Phosphor Bronze				
Wire \ Ckt. Size	2 & 3	4 - 6	7 - 10	12 - 24	Wire \ Ckt. Size	2 & 3	4 - 6	7 - 10	12 - 24
AWG #16	9	8	7	6	AWG #16	8	7	6	5
AWG #18	9	8	7	6	AWG #18	8	7	6	5
AWG #20	7	6	5	5	AWG #20	6	5	4	4
AWG #22	5	4	4	4	AWG #22	4	3	3	3
AWG #24	4	3	3	3	AWG #24	3	2	2	2
AWG #26	3	2	2	2	AWG #26	2	1	1	1
AWG #28	2	1	1	1	AWG #28	1	1	1	1

4.3 TEMPERATURE

Operating: * - 40°C to + 105°C

Nonoperating: - 40°C to + 105°C

*Including 30°C terminal temperature at rated current

5.0 PERFORMANCE

5.1 ELECTRICAL REQUIREMENTS

ITEM	DESCRIPTION	TEST CONDITION	REQUIREMENT
1	Contact Resistance (Low Level)	Mate connectors: apply a maximum voltage of 20 mV and a current of 100 mA. Wire resistance shall be removed from the measured value.	10 milliohms MAXIMUM [initial]
2	Contact Resistance @ Rated Current	Mate connectors: apply a maximum voltage of 20 mV at rated current.	10 milliohms MAXIMUM [initial]
3	Contact Resistance of Wire Termination (Low Level)	Terminate the applicable wire to the terminal and measure wire using a voltage of 20 mV and a current of 100 mA.	5 milliohms MAXIMUM [initial]
4	Insulation Resistance	Mate connectors: apply a voltage of 500 VDC between adjacent terminals and between terminals to ground.	1000 Megohms MINIMUM

REVISION: C	EGR/ECN INFORMATION: EC No: UCP2004-2349 DATE: 2004 / 05 / 25	TITLE: PRODUCT SPECIFICATION FOR MINI-FIT JR. CONNECTOR SYSTEM	SHEET No. 2 of 5
DOCUMENT NUMBER: PS-5556-001		CREATED / REVISED BY: BANDURA	CHECKED BY: BANDURA
		APPROVED BY: MARGULIS	



PRODUCT SPECIFICATION

5.1 ELECTRICAL REQUIREMENTS (continued)

ITEM	DESCRIPTION	TEST CONDITION	REQUIREMENT
5	Dielectric Withstanding Voltage	Mate connectors: apply a voltage of 1500 VAC for 1 minute between adjacent terminals and between terminals to ground.	No breakdown. Current leakage < 5 mA
6	Temperature Rise (via Current Cycling)	Mate connectors. Measure the temperature rise at the rated current after 96 hours, during current cycling (45 minutes ON and 15 minutes OFF per hour) for 240 hours, and after final 96-hour steady state.	Temperature rise: +30°C MAXIMUM

5.2 MECHANICAL REQUIREMENTS

ITEM	DESCRIPTION	TEST CONDITION	REQUIREMENT
1	Terminal Insertion and Withdrawal Forces	Insert and withdraw terminal (male to female) at a rate of 25 ± 6 mm (1 ± ¼ inch) per minute.	14.7 N (3.30 lbf) MAXIMUM insertion force & 1.0 N (0.02 lbf) MINIMUM withdrawal force
2	Terminal Retention Force (in Housing)	Axial pullout force on the terminal in the housing at a rate of 25 ± 6 mm (1 ± ¼ inch) per minute.	30 N (6.74 lbf) MINIMUM retention force
3	Durability	Mate connectors up to 30 cycles at a maximum rate of 10 cycles per minute prior to Environmental Tests.	20 milliohms MAXIMUM
4	Vibration (Random)	Mate connectors and vibrate per EIA 364-28, test condition VII.	10 milliohms MAXIMUM (change from initial) & Discontinuity < 1 microsecond
5	Shock (Mechanical)	Mate connectors and shock at 50 g's with ½ sine wave (11 milliseconds) shocks in the ±X, ±Y, ±Z axes, (18 shocks total).	20 milliohms MAXIMUM & Discontinuity < 1 microsecond
6	Wire Pullout Force (Axial)	Apply an axial pullout force on the wire at a rate of 25 ± 6 mm (1 ± ¼ inch).	16 Awg = 88.0 N (19.8 lbf) Min. 18 Awg = 88.0 N (19.8 lbf) Min. 20 Awg = 59.0 N (13.3 lbf) Min. 22 Awg = 39.0 N (8.78 lbf) Min. 24 Awg = 29.0 N (6.52 lbf) Min. 26 Awg = 19.0 N (4.27 lbf) Min. 28 Awg = 9.80 N (2.20 lbf) Min.

REVISION: C	EGR/ECN INFORMATION: EC No: UCP2004-2349 DATE: 2004 / 05 / 25	TITLE: PRODUCT SPECIFICATION FOR MINI-FIT JR. CONNECTOR SYSTEM	SHEET No. 3 of 5
DOCUMENT NUMBER: PS-5556-001	CREATED / REVISED BY: BANDURA	CHECKED BY: BANDURA	APPROVED BY: MARGULIS



PRODUCT SPECIFICATION

5.2 MECHANICAL REQUIREMENTS (continued)

7	Terminal Insertion Force (into Housing)	Apply an axial insertion force on the terminal at a rate of 25 ± 6 mm ($1 \pm \frac{1}{4}$ inch).	15.0 N (3.37 lbf) MAXIMUM insertion force
8	Normal Force	Apply a perpendicular force.	0.49 N (50 grams) MINIMUM [Gold (noble) plating] OR 1.47 N (150 grams) MINIMUM [Tin (non-noble) plating]
9	PCB Engagement and Separation Forces	Engage and separate a connector at a rate of 25 ± 6 mm ($1 \pm \frac{1}{4}$ inch) per minute. (Applies to parts with PCB retention features only)	49.0 N (11.0 lbf) MAXIMUM insertion force & 10.0 N (2.24 lbf) MINIMUM withdrawal force
10	Panel Insertion and Withdrawal Forces	Insert and withdraw a connector at a rate of 25 ± 6 mm ($1 \pm \frac{1}{4}$ inch) per minute. (Applies to parts with panel retention features only)	225 N (50.7 lbf) MAXIMUM insertion force & 157 N (35.3 lbf) MINIMUM withdrawal force
11	Pin Retention Force	Apply axial push force at the speed rate of 25 ± 3 mm/minute.	1.0 KGF MIN.
12	Thumb latch Operation Force	Depress latch at a speed rate of 25.4 mm/minute.	1.7 KGF MAX.
13	Thumb latch Yield Strength	Mate loaded connectors fully. Pull apart via wires at a speed rate of 25.4 mm/minute.	7.0 KGF MIN.

<u>REVISION:</u> C	<u>EGR/ECN INFORMATION:</u> EC No: UCP2004-2349 DATE: 2004 / 05 / 25	<u>TITLE:</u> PRODUCT SPECIFICATION FOR MINI-FIT JR. CONNECTOR SYSTEM	<u>SHEET No.</u> 4 of 5
<u>DOCUMENT NUMBER:</u> PS-5556-001	<u>CREATED / REVISED BY:</u> BANDURA	<u>CHECKED BY:</u> BANDURA	<u>APPROVED BY:</u> MARGULIS



PRODUCT SPECIFICATION

5.3 ENVIRONMENTAL REQUIREMENTS (continued)

ITEM	DESCRIPTION	TEST CONDITION	REQUIREMENT
1	Thermal Shock	Mate connectors: expose for 5 cycles Between temperatures -55 and 105° C; Dwell 0.5 hours at each temperature.	20 milliohms MAXIMUM Visual: No Damage Dielectric Strength per 5.1.5 Insulation Resistance per 5.1.4
2	Thermal Aging	Mate connectors; expose to: 96 hours at 105 ± 2°C	20 milliohms MAXIMUM & Visual: No Damage
3	Humidity (Steady State)	Mate connectors: expose to a temperature of 60 ± 2°C with a relative humidity of 90-95% for 96 hours.	20 milliohms MAXIMUM Dielectric Strength per 5.1.5 Insulation Resistance per 5.1.4 Visual: No Damage
4	Solderability	Per SMES-152	Solder coverage: 95% MINIMUM (per SMES-152)
5	Solder Resistance	Dip connector terminals tail in solder: Solder Duration: 5 ± 0.5 seconds; Solder Temperature: 260 ± 5°C	Visual: No Damage to insulator material
6	Cold Resistance	Mate connectors: Duration; 96 hours; Temperature: -40 ± 3°C	20 milliohms MAXIMUM Visual: No Damage
7	Corrosive Atmosphere: Sulfur Dioxide Gas (SO₂)	Mate connectors: Duration; 24 hours exposure. Atmosphere: 50 parts per million (ppm) SO ₂ Gas. Temperature: 40 ± 3°C	20 milliohms MAXIMUM Visual: No Damage

6.0 PACKAGING

Parts shall be packaged to protect against damage during handling, transit and storage.

REVISION: C	EGR/ECN INFORMATION: EC No: UCP2004-2349 DATE: 2004 / 05 / 25	TITLE: PRODUCT SPECIFICATION FOR MINI-FIT JR. CONNECTOR SYSTEM	SHEET No. 5 of 5
DOCUMENT NUMBER: PS-5556-001	CREATED / REVISED BY: BANDURA	CHECKED BY: BANDURA	APPROVED BY: MARGULIS



PRODUCT SPECIFICATION

<u>REVISION:</u> C	<u>EGR/ECN INFORMATION:</u> EC No: UCP2004-2349 DATE: 2004 / 05 / 25	<u>TITLE:</u> PRODUCT SPECIFICATION FOR MINI-FIT JR. CONNECTOR SYSTEM	<u>SHEET No.</u> 6 of 5
<u>DOCUMENT NUMBER:</u> PS-5556-001	<u>CREATED / REVISED BY:</u> BANDURA	<u>CHECKED BY:</u> BANDURA	<u>APPROVED BY:</u> MARGULIS



PRODUCT SPECIFICATION

REVISION: C	EGR/ECN INFORMATION: EC No: UCP2004-2349 DATE: 2004 / 05 / 25	TITLE: PRODUCT SPECIFICATION FOR MINI-FIT JR. CONNECTOR SYSTEM	SHEET No. 7 of 5
DOCUMENT NUMBER: PS-5556-001	CREATED / REVISED BY: BANDURA	CHECKED BY: BANDURA	APPROVED BY: MARGULIS

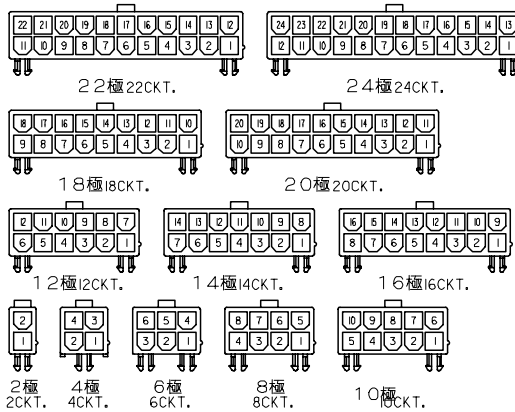
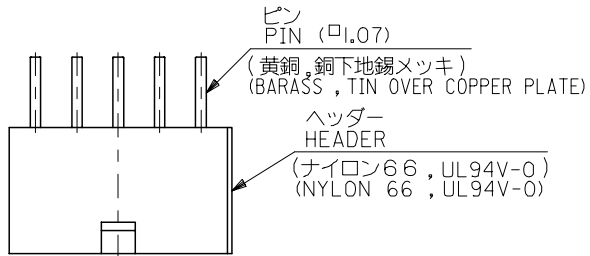

極数別レイアウト図
LAYOUT ACCORDING TO CKT NO.
(SCALE ; 1:1)

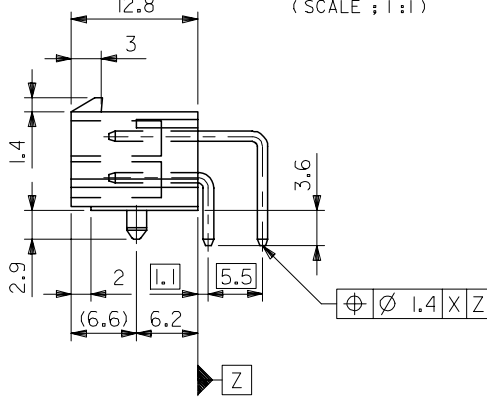
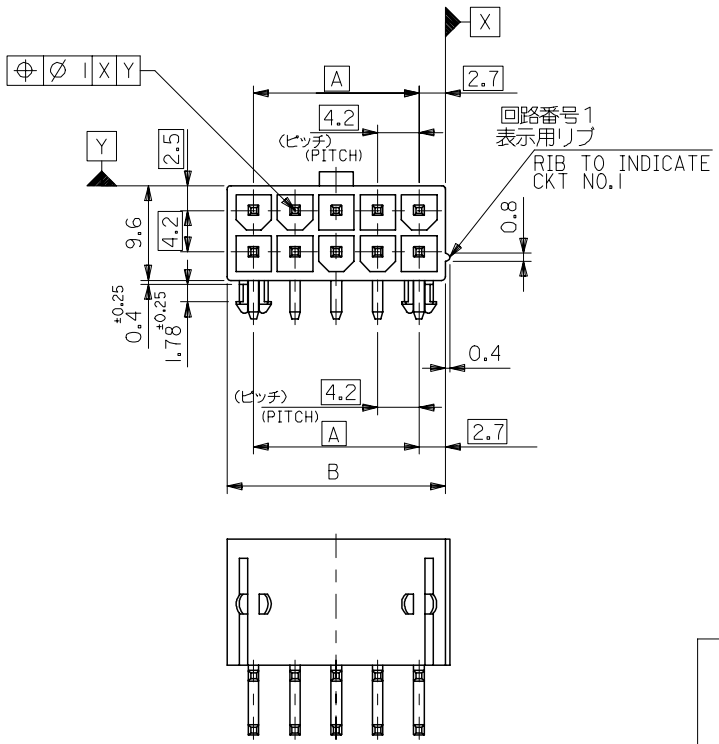
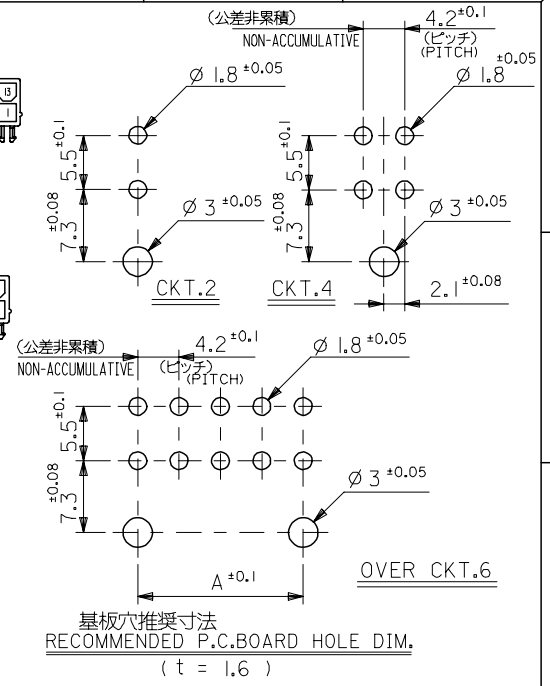

51.6	46.2	39-30-0240	5569-24A2-210	24
47.4	42.0	39-30-0220	5569-22A2-210	22
43.2	37.8	39-30-0200	5569-20A2-210	20
39.0	33.6	39-30-0180	5569-18A2-210	18
34.8	29.4	39-30-0160	5569-16A2-210	16
30.6	25.2	39-30-0140	5569-14A2-210	14
26.4	21.0	39-30-0120	5569-12A2-210	12
22.2	16.8	39-30-0100	5569-10A2-210	10
18.0	12.6	39-30-0080	5569-08A2-210	8
13.8	8.4	39-30-0060	5569-06A2-210	6
9.6	4.2	39-30-0040	5569-04A2-210	4
5.4	—	39-30-0020	5569-02A2-210	2
B	A	EDP NO.	ENG. NO.	極数

- 注記
NOTES
1. 嵌合相手: 5557-NR-210
MATES WITH : 5557-NR-210
 2. 一般公差: ±0.38
GENERAL TOLERANCE : ±0.38

材料
MATERIAL 図中参照
SEE DRAWING
仕上げ
FINISH 図中参照
SEE DRAWING

RELEASED	EC NO: J2007-1208	2006/10/27	GENERAL TOLERANCES (UNLESS SPECIFIED)	DIMENSION STYLE MM ONLY	SCALE 2:1	DESIGN UNITS METRIC	THIRD ANGLE PROJECTION
DRWN:KSAITO	0	2006/10/31	10 UNDER ±---	DRAWN BY K.SAITO	DATE 2006/10/24	TITLE MINI-FIT JR R/A HEADER ASSY WITH MOUNTING PEGS	
CHKD:KTOYODA		2006/10/31	10 OVER 30 UNDER ±---	CHECKED BY K.TOYODA	DATE 2006/10/24	MOLEX	MOLEX INCORPORATED
APPR:NUKITA		2006/10/31	30 OVER ±---	APPROVED BY N.UKITA	DATE 2006/10/24	DOCUMENT NO. SD-5569-001	SHEET NO. 1 OF 1
DESCRIPTION			ANGULAR ±---°	MATERIAL NO.		SEE CHART	
			DRAFT WHERE APPLICABLE MUST REMAIN WITHIN DIMENSIONS	SIZE A3		THIS DRAWING CONTAINS INFORMATION THAT IS PROPRIETARY TO MOLEX INCORPORATED AND SHOULD NOT BE USED WITHOUT WRITTEN PERMISSION	

LEGEND:

5569 - N A * * * *

BASE NUMBER

CIRCUIT SIZE

ASSEMBLY

MOUNTING OPTION (SEE NOTE 6.)

PLATING (SEE NOTE 2.)

HOUSING MAT'L. (SEE NOTE 1.)

CIRCUIT SIZE	DIM. "A"	DIM. "B"
6	.54 (13.8)	.33 (8.4)
8	.71 (18.0)	.50 (12.6)
10	.87 (22.2)	.66 (16.8)
12	1.04 (26.4)	.83 (21.0)
14	1.20 (30.6)	.99 (25.2)
16	1.37 (34.8)	1.16 (29.4)
18	1.54 (39.0)	1.32 (33.6)
20	1.70 (43.2)	1.49 (37.8)
22	1.87 (47.4)	1.65 (42.0)
24	2.03 (51.6)	1.82 (46.2)

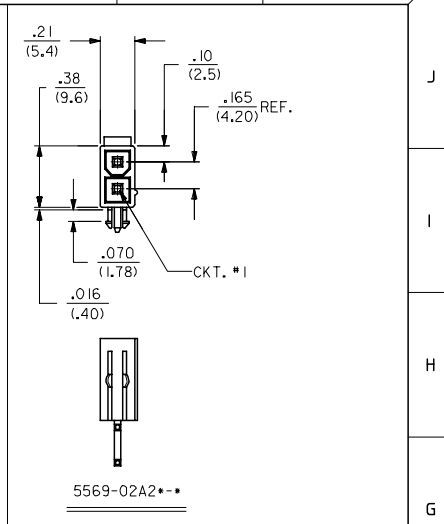
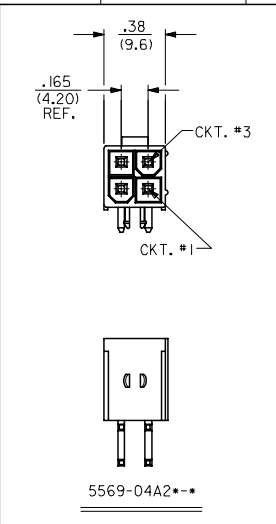
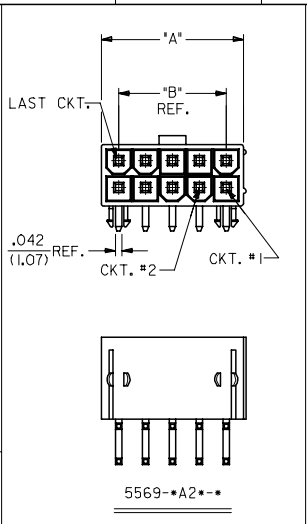
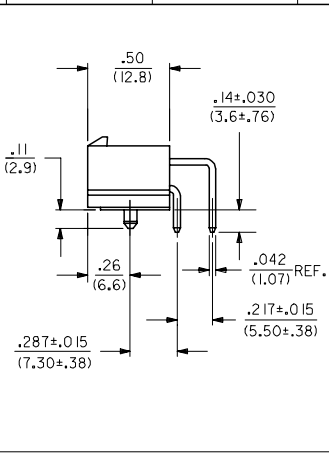

- NOTES:**
- MATERIAL; HOUSING:**
 - "BLANK" = NYLON (PA66), UNFILLED, UL94V-2, COLOR: NATURAL
 - "100" = NYLON (PA66), UNFILLED, UL94V-2, COLOR: BLACK
 - "BL" = NYLON (PA66), UNFILLED, UL94V-2, COLOR: BLACK
 - "210" = NYLON (PA66), UNFILLED, UL94V-0, COLOR: NATURAL
 - "400" = NYLON (PA66), UNFILLED, UL94V-0, COLOR: BLACK
 - FINISH (PLATING):**
 - "A" = .000200/(0.00508) MIN. BRIGHT TIN OVER
 - "G" = .000100/(0.00254) MIN. COPPER
 - "G2" = .000030/(0.00076) MIN. GOLD OVER
 - "G3" = .000050/(0.00127) MIN. NICKEL
 - "GS" = .000015/(0.00038) MIN. GOLD OVER
 - "GS2" = .000030/(0.00076) MIN. NICKEL
 - "GS3" = .000050/(0.00127) MIN. GOLD OVER
 - "S" = .000100/(0.00254) MIN. BRIGHT TIN OVER
 - *THE PRIMARY SHIPPING CARTON WILL BE LABELED "COMPLIANT TO RoHS DIRECTIVE 2002/95/EC AND ELV ANNEX II OF DIRECTIVE 2000/53/EC"; CARTONS WITHOUT THIS LABEL MAY CONTAIN PRODUCT WITH TIN-LEAD PLATING.
 - PRODUCT SPECIFICATION: SHOWN IN CHART AT RIGHT
 - PACKAGING: BULK
 - PART MATES WITH MINI-FIT JR. RECEPTACLE SERIES 5557.
 - MOUNTING OPTIONS:
 - 1 = SCREW MOUNT (SEE SD-5569-NA* SERIES DRAWING)
 - 2 = PEG MOUNT
 - DISCOLORATION IN THE BANDOLIER CARRIER AREA OF THE PIN IS INHERENT TO THE PLATING PROCESS AND IS DUE TO THE MASKING EFFECT OF THE CARRIER. THIS DISCOLORATION IS IN A NON-FUNCTIONAL AREA OF THE PIN AND WILL NOT AFFECT THE PERFORMANCE OF THE HEADER ASSEMBLY.
 - PART CONFORMS TO CLASS "B" REQUIREMENTS OF COSMETIC SPECIFICATION PS-45499-002.
 - CONNECTORS ARE NOT TO BE MATED AND UNMATED WHILE CIRCUITS ARE LIVE.
 - PARTS ARE NOT DESIGNED FOR CURRENT SHARING.

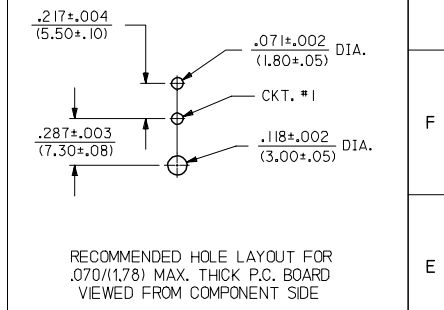
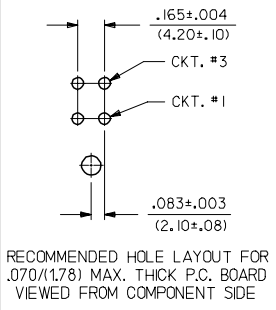
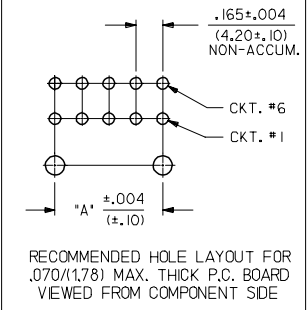

5569-A2S-BL	PS-5556-001
5569-A2G3-BL	PS-5556-001
5569-A2G2-BL	PS-5556-001
5569-A2G-BL	PS-5556-001
5569-A2-BL	PS-5556-001
5569-A2G3 & -A2G3-210	PS-5556-001
5569-A2S & -A2S-210	PS-5556-001
5569-A2GS3 & -A2GS3-210	PS-5556-001
5569-A2GS2 & -A2GS2-210	PS-5556-001
5569-A2GS & -A2GS-210	PS-5556-001
5569-A2G2 & -A2G2-210	PS-5556-001
5569-A2G & -A2G-210	PS-5556-001
5569-A2 & -A2-210	PS-5556-001

5	K1
4	K1
3	K1
2	K1
1	K3

ENG. NO.	PROD. SPEC. NO.
PRODUCT SPEC. CHART	

UPDATED NOTES	QUALITY SYMBOLS
EC NO: UCP2007-0664	▽=0
DRW:WLSCHM1D1	▽=0
CHKD: 2006/09/25	
APPR:FSM TH	
2006/09/26	
REV	
K3	

GENERAL TOLERANCES (UNLESS SPECIFIED)	
mm	INCH
4 PLACES ± ---	± ---
3 PLACES ± ---	± .010
2 PLACES ± .25	± .015
1 PLACE ± .38	± ---
ANGULAR ±1/2°	

DIMENSION STYLE	
IN/MM	DATE
DRAWN BY	RJF
DATE	02/16/88
CHECKED BY	GT
DATE	02/16/88
APPROVED BY	RAS
DATE	02/16/88
MATERIAL NO.	
DOCUMENT NO.	

SCALE 1:1 DESIGN UNITS METRIC

THIRD ANGLE PROJECTION

MINI-FIT JR RIGHT ANGLE HEADER ASSEMBLIES WITH MOUNTING PEGS

MOLEX MOLEX INCORPORATED

DRAFT WHERE APPLICABLE MUST REMAIN WITHIN DIMENSIONS

SEE CHART

SDA-5569-NA2*-*

SHEET NO. 1 OF 5

THIS DRAWING CONTAINS INFORMATION THAT IS PROPRIETARY TO MOLEX INCORPORATED AND SHOULD NOT BE USED WITHOUT WRITTEN PERMISSION

SEE SHEET ONE
EC NO: UCP2005-1130
DRAWN: STEWART 2004/12/04
CHKD: GPOLGAR 2004/12/09
APPR: YMARGULLI 2004/12/13

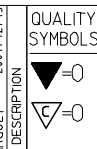

GENERAL TOLERANCES (UNLESS SPECIFIED)	
mm	INCH
4 PLACES ± .010	± .0004
3 PLACES ± .015	± .0006
2 PLACES ± .020	± .0008
1 PLACE ± .030	± .0012
ANGULAR ±1/2°	

DIMENSION STYLE	
IN/MM	
DRAWN BY	DATE
RJF	08/16/88
CHECKED BY	DATE
JTR	08/16/88
APPROVED BY	DATE
RAS	08/16/88
MATERIAL NO.	DOCUMENT NO.
SDA-5569-NA2*-*	SDA-5569-NA2*-*

SCALE 1:1
DESIGN UNITS INCH
THIRD ANGLE PROJECTION
MINI-FIT JR. RIGHT ANGLE HEADER ASSEMBLIES WITH MOUNTING PEGS
MOLEX INCORPORATED
SHEET NO. 2 OF 5
THIS DRAWING CONTAINS INFORMATION THAT IS PROPRIETARY TO MOLEX INCORPORATED AND SHOULD NOT BE USED WITHOUT WRITTEN PERMISSION

PART NUMBER	ENG. NUMBER	CKT. SIZE	MTG. OPTION	PLATING (NOTE 6)	HSG. MAT'L.
39-30-1020	5569-02A2	2	PEGS	TIN OVER COPPER	94V-2
↑ -1040	↑ -04A2	4	↑	↑	↑
↑ -1060	↑ -06A2	6	↑	↑	↑
↑ -1080	↑ -08A2	8	↑	↑	↑
↑ -1100	↑ -10A2	10	↑	↑	↑
↑ -1120	↑ -12A2	12	↑	↑	↑
↑ -1140	↑ -14A2	14	↑	↑	↑
↑ -1160	↑ -16A2	16	↑	↑	↑
↑ -1180	↑ -18A2	18	↑	↑	↑
↑ -1200	↑ -20A2	20	↑	↑	↑
↑ -1220	↑ -22A2	22	↑	↑	↑
39-30-1240	5569-24A2	24	PEGS	TIN OVER COPPER	94V-2
39-30-1021	5569-02A2G	2	PEGS	30 M.I. GOLD	94V-2
↑ -1041	↑ -04A2G	4	↑	↑	↑
↑ -1061	↑ -06A2G	6	↑	↑	↑
↑ -1081	↑ -08A2G	8	↑	↑	↑
↑ -1101	↑ -10A2G	10	↑	↑	↑
↑ -1121	↑ -12A2G	12	↑	↑	↑
↑ -1141	↑ -14A2G	14	↑	↑	↑
↑ -1161	↑ -16A2G	16	↑	↑	↑
↑ -1181	↑ -18A2G	18	↑	↑	↑
↑ -1201	↑ -20A2G	20	↑	↑	↑
↑ -1221	↑ -22A2G	22	↑	↑	↑
39-30-1241	5569-24A2G	24	PEGS	30 M.I. GOLD	94V-2
39-30-0021	5569-02A2G2	2	PEGS	15 M.I. GOLD	94V-2
↑ -0041	↑ -04A2G2	4	↑	↑	↑
↑ -0061	↑ -06A2G2	6	↑	↑	↑
↑ -0081	↑ -08A2G2	8	↑	↑	↑
↑ -0101	↑ -10A2G2	10	↑	↑	↑
↑ -0121	↑ -12A2G2	12	↑	↑	↑
↑ -0141	↑ -14A2G2	14	↑	↑	↑
↑ -0161	↑ -16A2G2	16	↑	↑	↑
↑ -0181	↑ -18A2G2	18	↑	↑	↑
↑ -0201	↑ -20A2G2	20	↑	↑	↑
↑ -0221	↑ -22A2G2	22	↑	↑	↑
39-30-0241	5569-24A2G2	24	PEGS	15 M.I. GOLD	94V-2
NOT TOOLED	5569-02A2G3	2	PEGS	50 M.I. GOLD	94V-2
↑ -1514	↑ -04A2G3	4	↑	↑	↑
↑ -1511	↑ -06A2G3	6	↑	↑	↑
↑ -1512	↑ -08A2G3	8	↑	↑	↑
↑ -1503	↑ -10A2G3	10	↑	↑	↑
NOT TOOLED	↑ -12A2G3	12	↑	↑	↑
NOT TOOLED	↑ -14A2G3	14	↑	↑	↑
↑ -1513	↑ -16A2G3	16	↑	↑	↑
NOT TOOLED	↑ -18A2G3	18	↑	↑	↑
↑	↑ -20A2G3	20	↑	↑	↑
↑	↑ -22A2G3	22	↑	↑	↑
NOT TOOLED	5569-24A2G3	24	PEGS	50 M.I. GOLD	94V-2

13 12 11 10 9 8 7 6 5 4 3 2 1

12 11 10 9 8 7 6 5 4 3 2 1

J I H G F E D C B A

J I H G F E D C B A