

Distributed by:

JAMECO[®]
ELECTRONICS

www.Jameco.com ♦ 1-800-831-4242

The content and copyrights of the attached
material are the property of its owner.

Jameco Part Number 94714

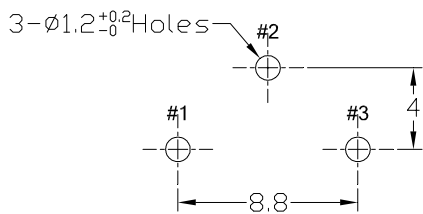
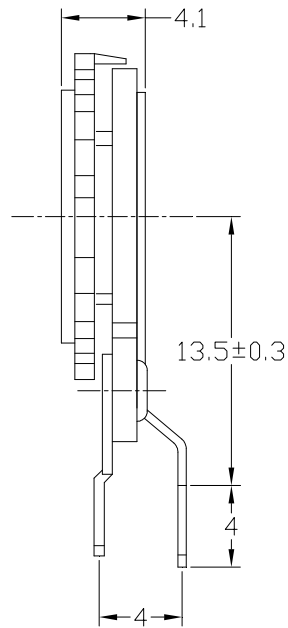
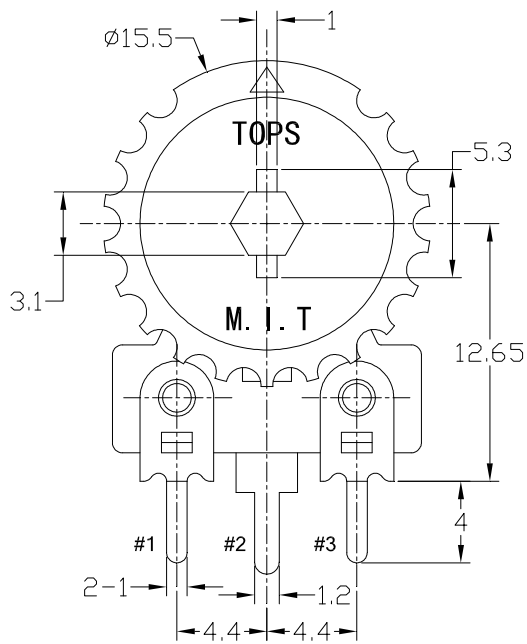

Mounting Hole Details

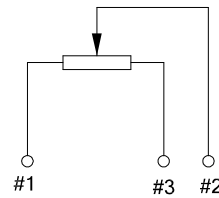

Circuit

NO INDICATION TOLERANCE	
LESS THAN 10	± 0.3
ABOVE 10 TO 30	± 0.5
ABOVE 30 TO 100	± 1
ANGULAR DIMENSION	$\pm 5^\circ$

			PROJ. ANGLE		UNIT	MM	FILE NAME	
			DRAWN BY	CHECKED BY	APPROVED BY		ARTICLE NO.	
			WUZHENGWEI				DESIGNED NO.	SCALE
			2006. 11. 28					

CIC® **CIC COMPONENTS IND CO., LTD.**
 2F, No.3, Lane 130, Min-Chung Road, Hsin-Tien City
 Taipei Hsien, Taiwan, R.O.C.

158-36-8840

DRAWING NO.	EDITION	SHEET
DN2006112811		/

15 ϕ Series

- ◆ TOTL RESISTANCE 100 Ω ~5M Ω
- ◆ TOTL RESISTANCE TOLERANCE..... $\pm 20\%$
- ◆ $\leq 500 \Omega$ or $\geq 500K \Omega$ $\pm 30\%$
- ◆ RESISANCE TAPER A.B.C
- ◆ MAX. OPERATION VOLTAGE LINEAR TAPER AC 250V
- ◆ RATED POWER LINEAR TAPER 0.25W
- ◆ OTHER TAPER G:0.125W
- ◆ INSRLATION RESISANCE MORE THAN 100M Ω AT DC 500V
- ◆ WITHSTAND VOLTAGE 1 MINUTE AT AC 500V
- ◆ RESIDRAL RESISTANCE TERM. 1~2: LESS THAN 10 Ω or $< 1\%$
 TERM. 1~3: LESS THAN 10 Ω or $< 1\%$
- ◆ TOTAL ROTATIONAL ANGLE 270° $\pm 20^\circ$
- ◆ ROTATIONAL TORQUE 20gf.cm ~ 250gf.cm
- ◆ ROTATIONAL STOPPER STRENGTH > 10Num (14 OZ/IN).
- ◆ PUSH-PULL STRENGTH > 25N (90 OZ)
- ◆ ROTATIONAL LIFE 500 CYCLES
- ◆ OPERATION LIFE 1,000 CYCLES
 RESISTANCE VALUE $\pm 20\%$

TAPERS B SERIES

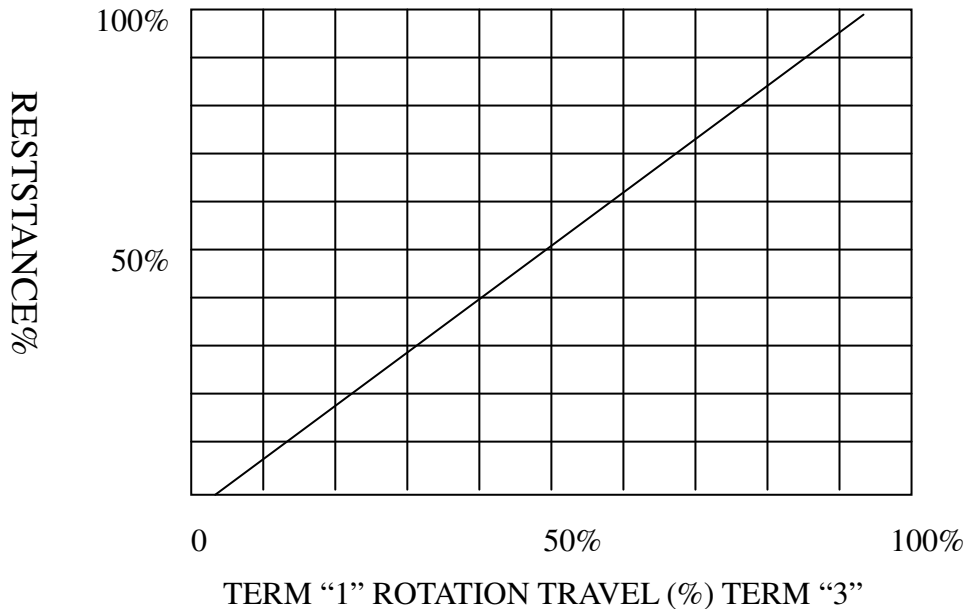

TAPERS A SERIES

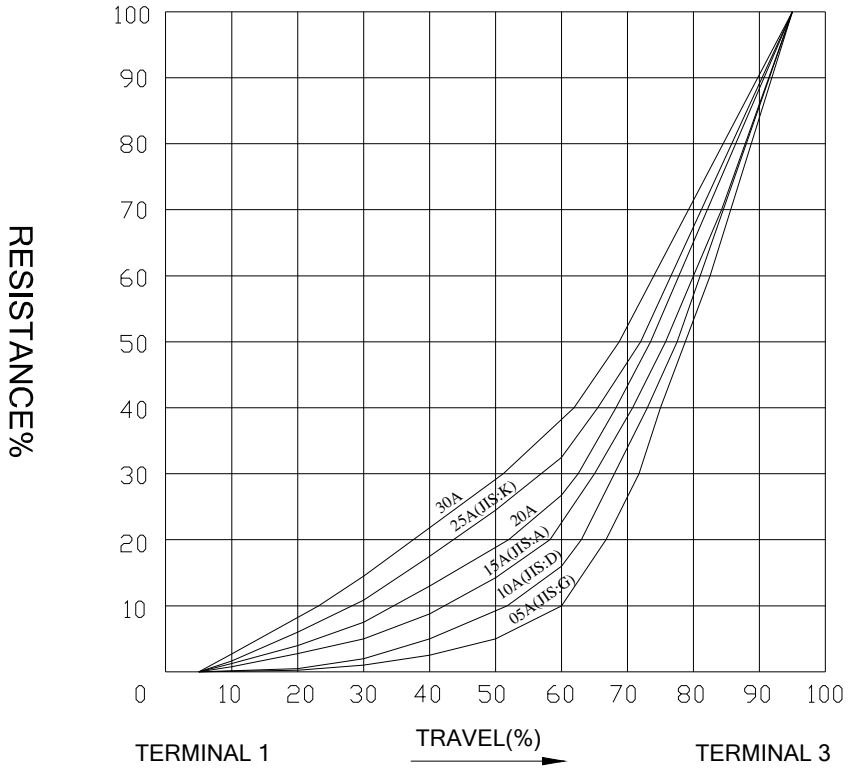

TAPERS C SERIES

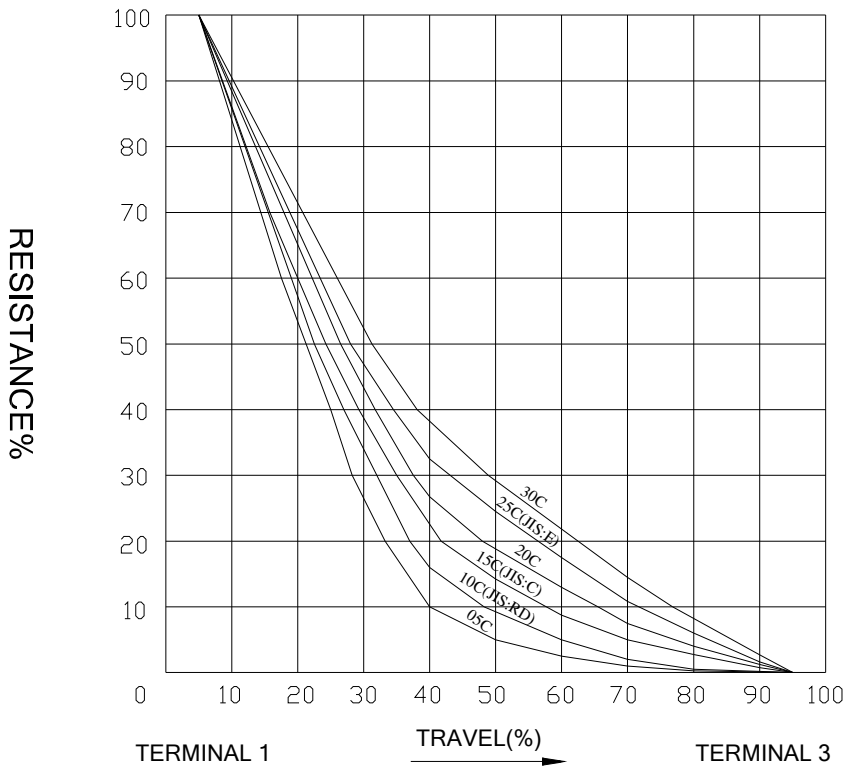

15 § Electrical characteristics

電氣性能

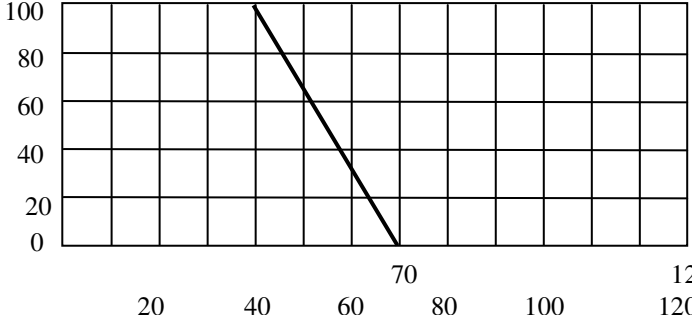
Total resistance 總阻值	B taper $100\Omega \sim 5M\Omega$ (Lin) A, C taper $1K \sim 1M\Omega$ (Log, Alog)
Total resistance tolerance 總阻值容許差	$\pm 20\%$ $\leq 500\Omega$ or $\geq 500K\Omega \pm 30\%$
Rated power 定格電力	$0.25W/40^\circ C$ $0W/70^\circ C$
Temperature range 環境溫度範圍	$-25^\circ C \sim 70^\circ C$ (附圖一) Rated power % 
Max. Operating Voltage 最高耐電壓	$250V$ A C $E: \sqrt{P \cdot R}$ E: Operating voltage P: Rated power R: Total resistance
Residual Resistance 殘留阻值	Term 1~2 : Less than 10Ω or $<1\%$ Term 2~3 : Less than 10Ω or $<1\%$
Rotational noise 轉動噪音	$150mv$ max.
Resistance temperature coefficient 電阻溫度係數	$850ppm/^\circ C$

15 § 電氣性能 Electrical Characteristics

序號 NO	項目 ITEM	測試條件 TEST CONDITION	規格 SPECIFICATIONS
1.1	絕緣阻抗 Insulation resistance	以 DC 500V 之電壓，測試 1 分鐘測試位置端子與主軸 Test voltage: DC 500V Test position: Between terminals and the shaft for 1minute ± 5 seconds.	100MΩ min
1.2	耐壓電 Withstand voltage	以 AC 500V(50~60Hz2mA)壓電，測試 1 分鐘測試位置端子與主軸 Test voltage: AC 500V (50~60Hz2mA)，measured for 1minute Test position: Between terminals and the shaft 1 minute ± 5	不可有絕緣破壞 No dielectric breakdown shall be occurred

機械性能 Mechanical Characteristics

序號 NO	項目 ITEM	測試條件 TEST CONDITION	規格 SPECIFICATIONS
2.1	操作力矩 Operating torque	-25°C~70°C	20~250gf.cm
2.2	止擋強度 Shaft stopper strength	將主軸轉到起點或終點處，施加力矩 1kgf.cm(10N.m)，保持 15 秒鐘 The shaft shall be rotated to one end or the other end with pull torque kgf.cm(10N.m) for 15 seconds	操作部和關連部不有變形破損 Without deformation or breads in the operating part and contact part
2.3	端子強度 Strength of terminals	於端子尖端各方向施加 500gf(5N)之力，保持 1 秒鐘 When 500gf(5N) are weighted on top of terminal in every direction for minute	無端子鬆動損壞，端子基板破裂等 Loose stale of terminal and damage on stator board should not exist
2.4	焊接性能 Solder ability	焊接溫度 Soldering temperature: 230±5°C 浸漬時間 Dipping time: 3±0.5 seconds	除切割面外，75%以上浸焊部位被焊料覆蓋 More than 75% of the dipping part shall be covered by solder，excluding the cutting surface
2.5	耐焊接	270°C 3±1 seconds	無端子鬆動損壞，端子基板破裂等 Loose stale of terminal and damage on stator board should not exist

15 § 耐候性 Weather Performance

序號 NO	項目 ITEM	測試條件 TEST CONDITION	規格 SPECIFICATIONS
3.1	耐濕度 Humidity Test	置於溫度 $40\pm 2^{\circ}\text{C}$ ，溼度 90~95%RH，500 小時後，放於正常環境下 1 小時，然後 1 小時內測試 Testing switch being kept in the conditions at $40\pm 2^{\circ}\text{C}$ and 90~95%RH for 500 hours in a normal ambient condition for 1 hour. Then to be measured within 1 hour.	絕緣電阻在 $10\text{M}\Omega$ 以上，500V DC，耐壓 AC500V 持續 1 分鐘操作力矩變化在 30%之內各部位無損壞，無機械性能異常電阻值變化 $\pm 10\%$ 以內 Insulation resistance: more than $10\text{M}\Omega$ for 500VDC Withstand voltage: 500Vac for 1 minute Operating torque: within $\pm 30\%$ of initial value Every parts should not defected in appearance and mechanical performance. Resistance $< \pm 10\%$
3.2	耐熱性 Heat Test	置於溫度 $70\pm 2^{\circ}\text{C}$ ，500 小時後，放於正常環境下 1 小時，然後在 1 小時內測試 Testing switch being kept in the conditions at $70\pm 2^{\circ}\text{C}$ in temperature for 500 hours in a normal ambient condition for an hour. The to be measured within hour.	
3.3	低溫特性 Cold Test	置於溫度 $-25\pm 2^{\circ}\text{C}$ ，500 小時後，放於正常環境下 1 小時，然後在 1 小時內測試 Testing switch should be kept in the condition in the temperature of $-25\pm 2^{\circ}\text{C}$ for 500 hours in a normal ambient condition for an hour. Then be measured within an hour.	

耐久性 Durability

序號 NO	項目 ITEM	測試條件 TEST CONDITION	規格 SPECIFICATIONS
4.1	壽命(無負荷) Life Test (Without Load) performance. Resistance $< \pm 2.0\%$	無負荷狀態連續測試，速度為 6~10 回/分，總次數為 500 次 500cycles of operation shall be performed continuously at the rate of 6 ~ 10 cycles/minute without load.	絕緣電阻在 $10\text{M}\Omega$ 以上，500VDC，耐壓 AC500V 持續 1 分鐘，操作力矩變化在 30%之內各部無損壞，無機械性能異常 Insulation resistance: more than $10\text{M}\Omega$ for 500VDC. Withstand voltage: 500VAC for 1 minute Operating torque: within $\pm 30\%$ of initial value Every parts should not defected in appearance and mechanical performance