

Distributed by:

**JAMECO**<sup>®</sup>  
ELECTRONICS

**www.Jameco.com ♦ 1-800-831-4242**

The content and copyrights of the attached  
material are the property of its owner.

Jameco Part Number 95417

Series 380, 53/RV4, 485

## 2 Watt, Conductive Plastic Potentiometer



### Description

The Series 380 "Quiet One" is a 2-watt conductive plastic potentiometer offering superior dynamic noise and a long rotational life. And it's manufactured to MIL-R-94 specifications where applicable.

Our 53/RV4 is a dual-marked potentiometer with all the fine features of the Series 380 in a more economical package. And it's built in strict accordance with MIL-R-94.

Series 485 has all the exceptional features of the 380 with a bonus of ten times the rotational life. (Special order only.)

### Features

- **Series 380**
  - 1% dynamic noise
  - 100,000 cycle life
  - Stainless-steel shaft
- **Series 53/RV4**
  - Economical
  - Wide range of values and tapers
  - Shaft and mounting seals available
- **Series 485**
  - 1% dynamic noise
  - 1 million cycle life
  - Available on special order only

### Series 380, 53/RV4, 485, Electrical Specifications

#### Resistance Range

50 $\Omega$  to 5 Megohms, linear.

250 $\Omega$  to 2.5 Megohms, tapered.

485 series only, 100 $\Omega$  to 2.5 Megohm, linear.

#### Resistance Tolerance

Linear, up to 1 Megohm  $\pm 10\%$ , above 1 Megohm  $\pm 20\%$ .

Tapers, up to 500K $\Omega$   $\pm 10\%$ ; above 500K $\Omega$   $\pm 20\%$ .

#### Power Rating (Watts)

2 watts maximum continuous power rating for linear taper, but voltage not to exceed rating. Full rating @ 70°C, derated linearly to zero watts at 120°C.

Derate all non-linear tapers by multiplying wattage rating by 0.5. See Chart A, page 44.

#### Electrical Rotation

312°  $\pm 3^\circ$  without switch; 333°  $\pm 3^\circ$  with switch.

#### Effective Rotation

270°, -0°/ +10°

#### Tapers

Right or left-hand available.

See Chart B, page 45.

#### End Resistance

Linear units: 4 $\Omega$  maximum for total resistances up to 250K; 10 $\Omega$  for resistances 250K and higher.

Taper units: High end of element 1% of total resistance or 4 $\Omega$  whichever is greater; low end same as for linear units.

#### Dielectric Strength

1000 Vac for 60 seconds @ ATM pressure.

450 Vac for 60 seconds @ 3.4 in. Hg.

#### Working Voltage

500 Vdc across end terminals, but power not to exceed rating.

#### Resistance Temperature Characteristics

See Chart C, page 45.

#### Dynamic Noise

Linear single controls maximum initial noise level of 1% of total resistance. Measurement made using a constant current source and oscilloscope detection technique.

#### Static noise

See Chart D, page 45.

#### Linearity

$\pm 5\%$  independent — linear tapers only

#### Voltage Coefficient

.005%/Volt, maximum

#### Switch Characteristics

##### Rotary

See Chart E, page 47.

**Mechanical Rotation**

312° ±3° without switch; 333° ±3° with switch

**Stop Torque Withstanding Strength**

12 lb. in. minimum, single shaft

8 lb. in. minimum, concentric shaft

**Torque Range**

Single control 1 oz. in. to 4 oz. in., 2 oz. in. variation through mechanical rotation within a control.

Single control with shaft seal 1 oz. in. to 6 oz. in.

Single control with shaft locking feature and jam nut tightened to 10 lb. in. Starting torque is 30 oz. in.

**Standard Bushing Lengths**

Plain, 1/4 in. (6.35mm), 3/8 in. (9.53mm), 1/2 in. (12.7mm)

Panel Seal, 3/8 in. (9.53mm)

Shaft Locking, 1/2 in. (12.7mm)

Thread, 3/8 in. (9.53mm)-32 NEF-2A

Other bushings available on special order.

**Standard Shafts (Single Control Only)**

Standard diameter 1/4 in. (6.35mm). Standard lengths every 1/8 in. (3.18mm) from 3/8 in. (9.53mm) minimum to 5 in. (127 mm) maximum. 380, stainless steel.

53/RV4 and 485 brass, nickel-plated.

Available in round, slotted or flatted configurations. All shafts measured from mounting surface. Other shaft configurations available on special order.

**Weight**

Single .072 lbs. approximate

**Hardware**

Must be ordered separately.

(a) Hex mounting nut, 3/8 in. (9.53mm) x 32 -NEF-2A thread, 1/2 in. (12.7mm) across flats, 3/32 in. (2.38mm) thick.

(b) Internal tooth lockwasher, 11/16 in. (17.46mm) outer diameter. x .022 in. (0.56 mm) thick.

(c) Jam hex nut, 1/2 in. (12.7mm) across flats, 7/32 in. (5.56mm) thick, supplied on locking-type bushing.

**Marking**

Will appear on rear surface without switch. On periphery when switch is used. Unless otherwise specified, marking will consist of:

(a) Customer part number or Clarostat part number,

(b) EIA source and date code.

NOTE: SPECIFICATIONS SUBJECT TO CHANGE WITHOUT NOTICE.

**Operating Temperature Range**

-55°C to +120°C

**Rotational Life (Standard)**

**Series 380:** Rotational life for linear control; 100,000 cycles for units up to and including 100,000Ω, change not to exceed 5% R; above 100,000Ω change not to exceed 10% R.

**Series 53/RV4:** All resistance values: 25,000 cycles.

**Series 485:** 10% maximum change in total resistance as a result of 1,500,000 shaft rotations life test under full load for resistance values 1K to 2.5 Megohms; 1,000,000 shaft rotations under full load for resistance values 100Ω to 1KΩ

Figure 1

Chart A

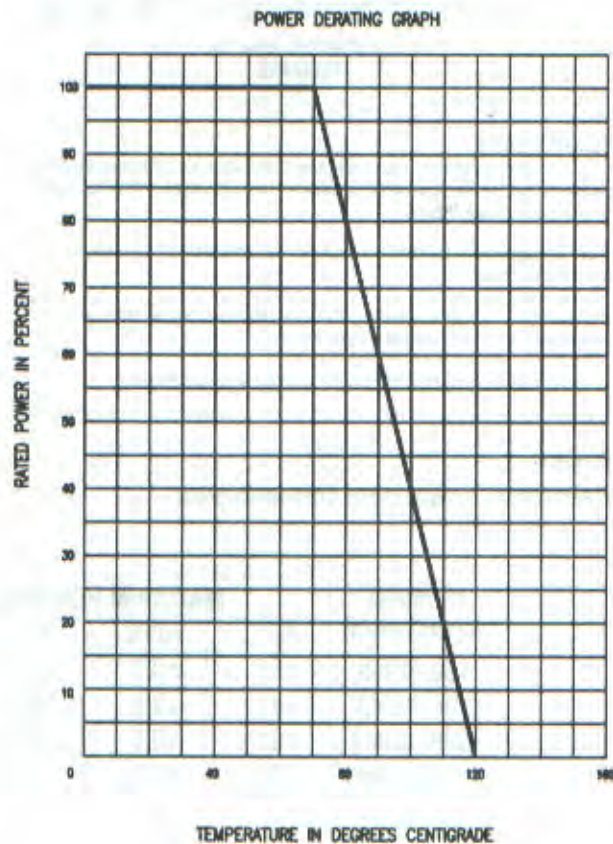
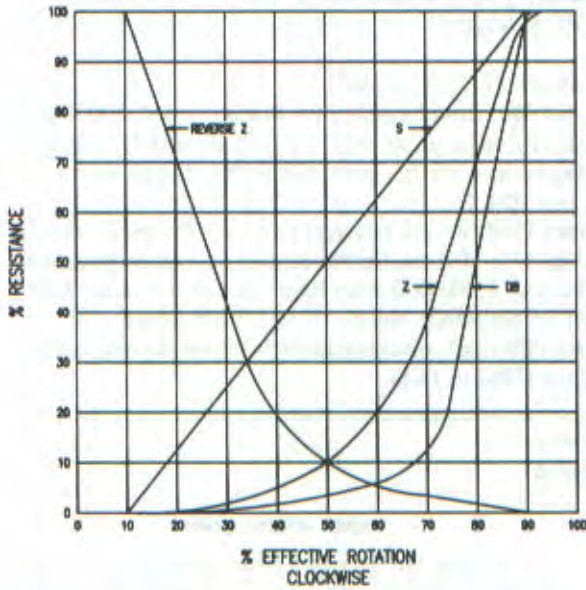

Figure 2

Chart B



**Curve Standard**

The "S" taper is linear, the change in resistance value being directly proportional to the degree of rotation. It can be used either as right-hand or left-hand taper.

The "Z" taper attains 10% resistance value at 50% of clockwise rotation (left-hand).

The reverse "Z" taper attains 10% resistance values at 50% of counter-clockwise rotation (right-hand).

For conformity and special output curves, consult factory.

Figure 3

Chart D

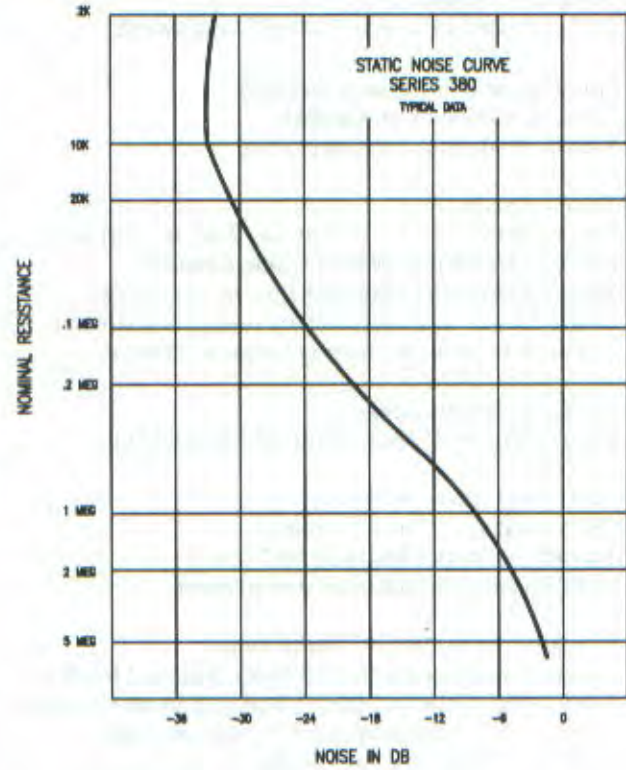

**Chart C**

**Resistance Temperature Characteristics**

NOMINAL RESISTANCE	MAXIMUM PERCENT TEMPORARY RESISTANCE FROM 25°C						
	-55°C	-40°C	0°C	+25°C	+85°C	+105°C	+120°C
100 OHMS	±5.0	±3.0	±1.5	0	±1.5	±2.5	±3.5
10K OHMS	+5.5	+4.0	+2.0	0	±2.5	±3.0	±4.0
100K OHMS	+6.5	+5.5	+2.0	0	±3.0	±4.0	±5.5
1 MEGOHMS	+9.0	+8.0	+2.5	0	±3.5	±5.5	±7.0

Figure 4

Series 380, 53/RV4 Dimensions

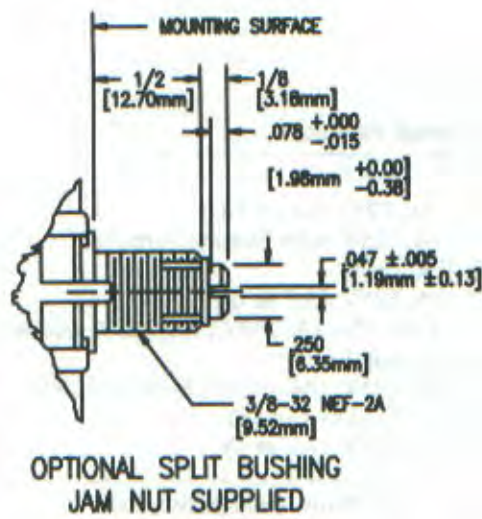
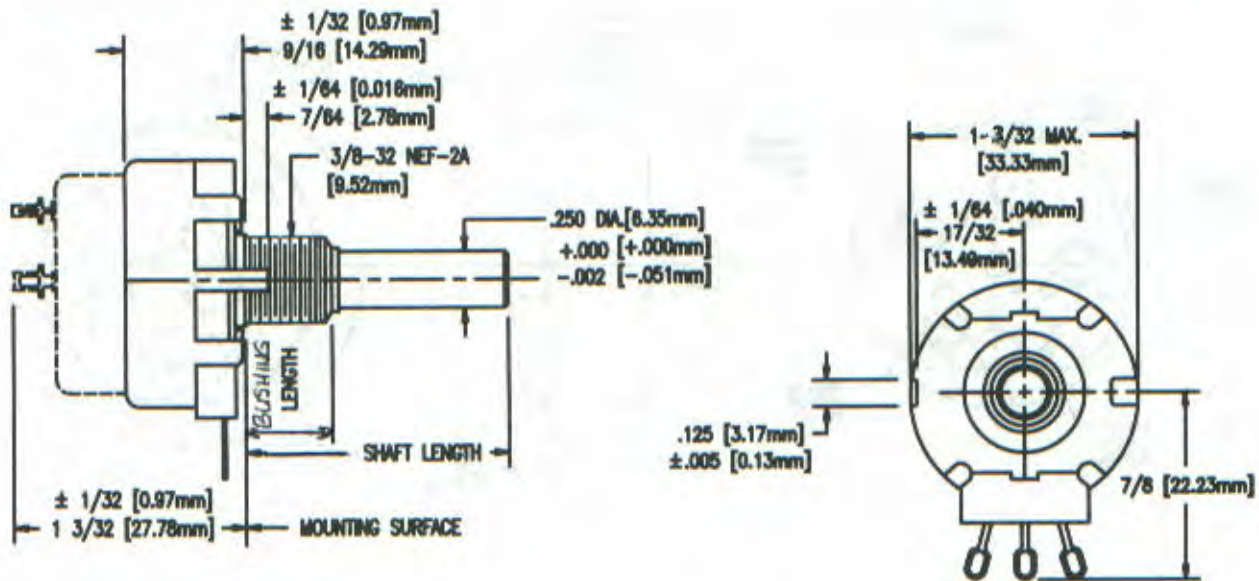
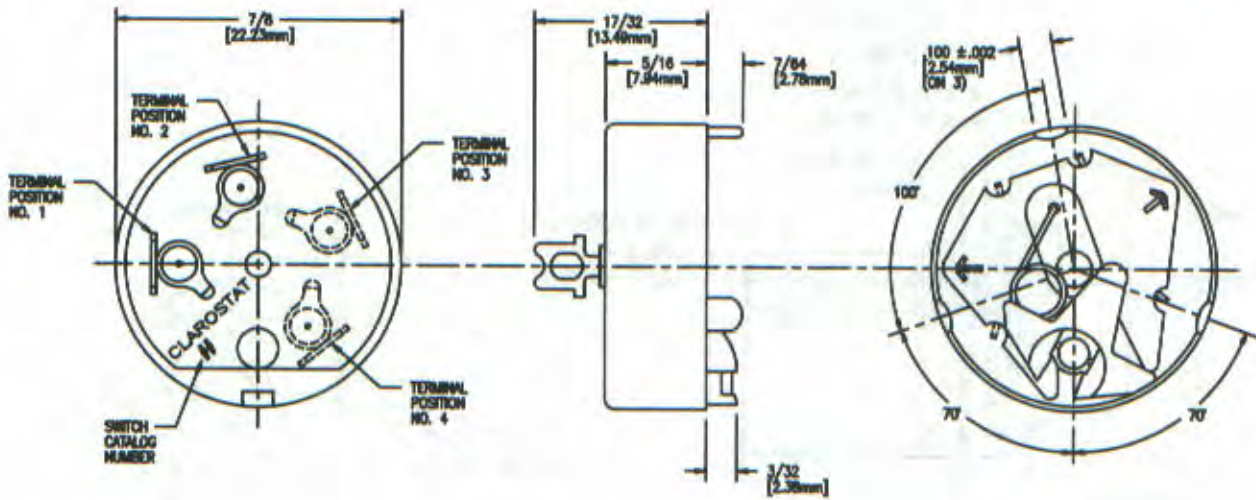

Figure 5  
Chart E



Type No.	Switch Variations	Terminal Positions	Max. Operating Torque-Oz. In.
AE-10	S.P.S.T. 1A, 250 V.; 3A, 125V (AC or DC)	1-2	12
AE-11	S.P.S.T. 1A, 250V.; 3A, 125V. with Bussing Terminal (AC or DC)	1-2-4	12
AE-13	S.P.S.T. 15A, 10V. (DC Only)	1-4	16
*AE-20	D.P.S.T. 1A, 250V.; 3A, 125V. (AC or DC)	1-2-3-4	16
AE-21	D.P. 1 Pole on, 1 Pole off—1A, 250V.; 3A, 125V. (Ac or DC)	1-2-3-4	16
AE-23	D.P.S.T. 15A, 10V. (DC only)	1-2-3-4	16
*AE-24	D.P.S.T. 1A, 250V.; 3A, 125V. (AC or DC) Reverse Action	1-2-3-4	16
AE-25	D.P.S.T. 250MA. 24V.D.C. (Dry Circuit)	1-2-3-4	12
AE-30	S.P.D.T. 1A, 250V.; 3A, 125V. (AC or DC)	2-3-4	16

\* May be employed as a single pole, single throw, two circuit switch.  
To Designate this application add an "A" to the end of switch type.  
Example: AE-20A

### Series 380 Standard Resistance Values

#### Stock Values (Ohms) Series 380C1

50	1000	10K	100K	1 meg
100	1500	15K	150K	1.5 meg*
150	2000	20K	200K	2 meg
250	2500	25K	250K	2.5 meg*
350*	3500*	35K	350K	3 meg*
500	5000	50K	500K	3.5 meg*
750*	7500*	75K*	750K	4 meg
				5 meg

\*Made-to-order; please consult Factory.

#### Stock Values (Ohms) Series 380C2

50*	1000	10K	100K	1 meg
100	1500*	15K	150K	1.5 meg
150	2000	20K	200K*	2 meg*
250	2500	25K	250K	2.5 meg*
350	3500	35K*	350K	3 meg*
500	5000	50K	500K	3.5 meg
750*	7500*	75K*	750K*	4 meg*
				5 meg

\*Made-to-order; please consult Factory.

#### Stock Values (Ohms) Series 380C3

50	1000	10K	100K	1 meg
100	1500	15K	150K	1.5 meg
150*	2000	20K	200K	2 meg
250	2500	25K	250K	2.5 meg
350*	3500	35K*	350K*	3 meg
500	5000	50K	500K	3.5 meg*
750*	7500*	75K	750K	4 meg
				5 meg

\*Made-to-order; please consult Factory.

### Series 380 How To Order

Catalog Number	Description
380C1	2" round shaft FMS; 3/8" long bushing with 3/8 x 32-NEF-2A thread.
380C2	5/8" screwdriver slotted shaft FMS; with a 1/2" split locking bushing.
380C3	7/8" screwdriver slotted shaft FMS; 3/8" long bushing with 3/8 x 32-NEF-2A thread.

Example: **380-C1-10K-S**

<b>380</b>	<b>C1</b>	<b>10K</b>	<b>S</b>
Series	Shaft & Bushing See Catalog Number and Description	Resistance Value (Ohms)	Taper See Chart B (Figure 2, page 45)

### Series 53 Standard Resistance Values

Series 53: Brass, nickel-plated shaft. Economical version of 380.

#### Series 53 Stock Values (Ohms)

##### 53C1, 53C2, 53C3 Linear

50	1500	20K	250K	3 Meg
100	2000	25K	350K	3.5 Meg
150	2500	35K	500K	4 Meg
250	3500	50K	750K	5 Meg
350	5000	75K	1 Meg	7.5 Meg
500	7500	100K	1.5 Meg	10 Meg
750	10K	150K	2.5 Meg	
1000	15K	200K		

Dual Taper D53C1	Z-Taper 53C1-Z	Reversed Z-Taper 53C1-RZ
---------------------	-------------------	-----------------------------

10K	500	150K	10K
25K	1K	200K	25K
50K	2.5K	250K	50K
100K	5K	500K	100K
250K	10K	750K	250K
500K	15K	1 Meg	500K
1 Meg	20K	2 Meg	
	25K	2.5 Meg	
	50K	5 Meg	
	100K		

### Series 53 How to Order

Catalog Number	Description
53C1	2 in. (.50.5mm) round shaft FMS; 3/8 in. (9.52mm) long bushing with 3/8 in. (9.52mm) x 32-NEF-2A thread.
53C2	5/8" screwdriver slotted shaft FMS; with a 1/2 in. (.50.5mm) split locking bushing.
53C3	7/8 in (22.22mm) screwdriver slotted shaft FMS; 3/8 in. (9.52mm) long bushing with 38 in. (203.2mm) x 32-NEF 2A thread.
53C1SW	Unsealed version of 53C1 available for use with field assembled switches. Order as 53C1 SW see table 1 for switch ordering.
53C1-Z	Same as 53C1 but with Z taper (see chart B, page 45).
53C1-RZ	Same as 53C1 but with Reversed Z taper (see chart B, page 45).
D53C1	Dual ganged. Bushing and shaft same as 53C1.

Table 1  
Switches for 53C1 SW only. Must be ordered separately on a made-to-order basis.

53-10	SPST-3A-125 Vac
53-20	DPST-3A-125 Vac
53-21	(Mod.) DPST-3A-125 Vac/dc

Series 53 How to Order, continued next page

Example: **53-C1-SW-1Meg-S**

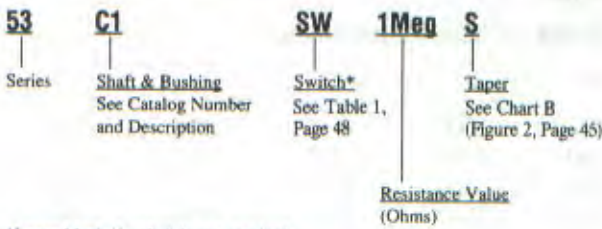

\*Leave blank if switch is not required.

**Series RV4 Standard Resistance Values**

Series RV4: Military version of Series 53

**RV4 Stock Values (Ohms, Tolerance and Tapers)**

<i>RV4NAYSD</i>				<i>RV4NAYSK</i>	
500A	252A	753A	205B	101A*	503A
101A	352A	104A	255B	251A*	104A*
151A	502A	154A	355B	501A*	254A
251A	752A	204A	505B	102A	504A
351A	103A	254A		252A*	105A*
501A	153A	354A		502A	255B
751A	203A	504A		103A	505B
102A	253A	754A		253A	
152A	353A	105A			
202A	503A	155B			

\*Made-to-order; please consult Factory.

<i>RV4LAYSA</i>				<i>RV4NAYSB</i>	
500A	252A	753A	205B	101A*	503A
101A	352A	104A	255B	251A	104A
151A	502A	154A	355B	501A	254A
251A	752A	204A	505B	102A	504A
351A	103A	254A		252A*	105A
501A	153A	354A		502A	255B
751A*	203A	504A		103A	505B*
102A	253A	754A		253A	
152A	353A	105A			
202A	503A	155B*			

\*Made-to-order; please consult Factory.

*RV4LAYSD*

101A	503A
251A	104A
501A	254A
102A	504A
252A	105A
502A	255B*
103A	505B
253A	

\*Made-to-order; please consult Factory.

**Series RV4 How To Order**

Example: **RV4-N-A-Y-S-D-10-4-A**

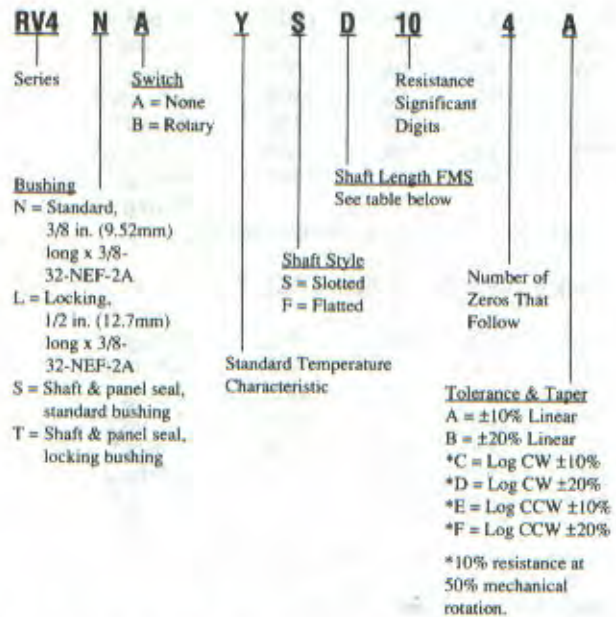

**Shaft Length from Mounting Surface Table**

Shaft Length Code	With 3/8 in. (9.52mm) Lg Bushings N & S	With 1/2 in. (12.7mm) Lg Bushings L & T
A	N/A	5/8 in. (15.88 mm)
B	1/2 in. (12.7 mm)	N/A
D	7/8 in. (22.23 mm)	7/8 in. (22.23 mm)
G	1 1/4 in. (31.75 mm)	N/A
J	2 in. (50.8 mm)	N/A
K	2 1/2 in. (63.5 mm)	N/A

N/A = Not available

**Series 485 How To Order**

Series 485 available on a made-to-order basis only. Please consult Factory for pricing, delivery, and minimums.